

**aquatherm**  
**2022**  
**Mayo**  
**LISTA DE PRECIOS**

**SISTEMAS DE TUBERÍAS PLÁSTICAS PARA INSTALACIONES**

aquatherm green pipe

aquatherm blue pipe

aquatherm red pipe

Made  
in  
Germany



**aquatherm ibérica**

# Cambio de codificación de los artículos de aquatherm

La lista de precios del año 2022, muestra una importante novedad y es la nueva codificación de los artículos de nuestro catálogo.

Después de más de 30 años manteniendo los mismos códigos pese a la gran cantidad de innovaciones y artículos nuevos que hemos ido introduciendo a lo largo de estos años, ha llegado el momento de reenumerar todas las familias, subfamilias y la totalidad de artículos con una nueva filosofía digital que nos preparara para los próximos años.

Esta nueva estructura de códigos forma parte de una renovación digital de la compañía que sin duda vendrá caracterizada por la introducción de nuevos productos y otra forma de relacionarnos con nuestros clientes.

Sabemos que les podrá causar pequeños inconvenientes durante los primeros días o semanas, pero les ayudaremos a resolver en todo momento las dudas que les puedan surgir, presentando además tanto los antiguos como los nuevos códigos al final de la lista de precios y en formato digital.

**green pipe**  
**aquatherm green pipe**  
RECOMENDADA PARA AGUA SANITARIA

**blue pipe**  
**aquatherm blue pipe**  
RECOMENDADA PARA CLIMATIZACIÓN

**red pipe**  
**aquatherm red pipe**  
RECOMENDADA PARA ROCIADORES Y BIE'S

**Capítulo 1: Sistemas de tubería** desde página 3

- 05 – **aquatherm green pipe**
- 09 – **aquatherm blue pipe**
- 14 – Soportación
- 15 – Accesorios
- 30 – Soldadura en asiento
- 36 – Elementos para electrofusión
- 39 – Elementos de transición
- 48 – Codo placa doble paso de caudal flujo a 90°
- 51 – Bloque distribuidor
- 52 – Push-fit
- 54 – Válvulas y accesorios

**Capítulo 2: aquatherm ti** desde página 62

- 64 – Tuberías
- 65 – Codos y Tes
- 72 – Manguitos
- 75 – Accesorios

**Capítulo 3: aquatherm red pipe** desde página 77

- 79 – Tuberías
- 80 – Accesorios PP-R
- 84 – Derivación en asiento
- 85 – Piezas de transición

**Capítulo 4: Herramientas** desde página 89

- 90 – Herramientas de Ritmo
- 91 – Equipos de soldadura
- 93 – Matrices de soldadura
- 94 – Accesorios de soldadura
- 96 – Herramientas de corte y pelado
- 98 – Herramienta derivación en carga

Presiones de servicio admisible desde página 99  
 Condiciones de venta desde página 103

## Otras tarifas 2022

Disponibles en formato pdf en la página web de aquatherm ibérica en el apartado documentación.

[www.aquatherm.es/area-tecnica/documentacion/](http://www.aquatherm.es/area-tecnica/documentacion/)

**aquatherm red pipe**

**aquatherm sistemas radiantes**

**aquatherm batería contadores**

**aquatherm grey pipe**

Todos los precios son por pieza, m, m<sup>2</sup>, Kg o conjunto.

Precio de venta recomendado por el fabricante.

Nuestras condiciones de venta y entrega y los contactos de nuestras ventas y de distribución figuran en nuestra página web de inicio [www.aquatherm.es](http://www.aquatherm.es)  
 Las características técnicas y precios están sujetos a cambios. Con la edición de esta lista de precios todas las anteriores quedan anuladas.

# Notas de interés

leyenda estructura de la tubería	
S	Monocapa (Single)
MF	Multicapa Faser (Multilayer Faser)
OT	Impermeable al oxígeno (Oxygen Tight)
UV	Resistencia UV (Ultra - Violeta)
TI	Aislamiento térmico (Thermal Isolation)
HI	Difícilmente inflamable (Hardly Inflammable)

**DN** = Diámetro Nominal, es el diámetro EXTERIOR de la tubería.  
**e** = Espesor de la pared del tubo. Depende de la SERIE / SDR del mismo.

$$\text{Serie} = \frac{\text{DN} - e}{2e}$$

$$\text{SDR} = \frac{\text{DN}}{e}$$

$$\text{SDR} = 2 \cdot \text{Serie} + 1$$

## CAMPOS DE APLICACIÓN



Agua Potable



Calefacción



Climatización



Suelo Radiante



Pared Radiante



Techo Radiante



Refrigeración Superficie Industrial



Calefacción Superficie Industrial



Agua Refrigerada



Agricultura



Sup. Deportivas (calefacción / refrigeración)



Piscinas



Transporte Productos Químicos



Aplicaciones con Agua de Lluvia



Riego



Rociadores y BIEs



Industria Naval



Distric Heating & Cooling



Geotermia

## SOLDADURA

DN32 DN40 DN50 DN63 DN75 DN90 DN110 DN125 DN160 DN200 DN250 ..... DN630

SOLDADURA A ENCHUFE

SOLDADURA A TOPE

La Información referente a como realizar la soldadura de las tuberías se encuentra en el capítulo FUSIÓN de la Documentación Técnica. Solicítela a través de:

[info@aquatherm.es](mailto:info@aquatherm.es) o [www.aquatherm.es](http://www.aquatherm.es)

# aquatherm green pipe

**Sistema de tuberías de Polipropileno**  
para suministro de agua potable

# aquatherm blue pipe

**Sistema de tuberías de Polipropileno**  
para agua enfriada, caliente y diversas aplicaciones industriales. Estructura de la nueva denominación.

## Tuberías de polipropileno y sus accesorios para la completa y correcta instalación.

Uno de los sistemas de mayor eficiencia energética en el transporte de agua sanitaria fría y caliente, refrigerada y de calefacción y reutilizada.

- **aquatherm green pipe**

Tubería compuesta con fibra Serie 3,2/ SDR 7,4  
Tubería compuesta con fibra Serie 4/ SDR 9  
Tubería monocapa Serie 5/ SDR 11  
Sistema de tuberías para agua potable  
Dimensiones DN16 – DN355

- **aquatherm blue pipe**

Tubería compuesta con fibra Serie 5/ SDR 11  
Tubería compuesta con fibra Serie 8,3/ SDR 17,6  
Tubería compuesta con fibra Serie 5/ SDR 11 y barrera antidifusora de oxígeno.  
Sistema de tuberías para calefacción y agua refrigerada.  
Dimensiones DN20 – DN630

Para información adicional pueden dirigirse a nuestro departamento técnico:

+34 91 380 66 08 Dpto Técnico  
tecnico@aquatherm.es

o visite nuestra web [www.aquatherm.es](http://www.aquatherm.es)

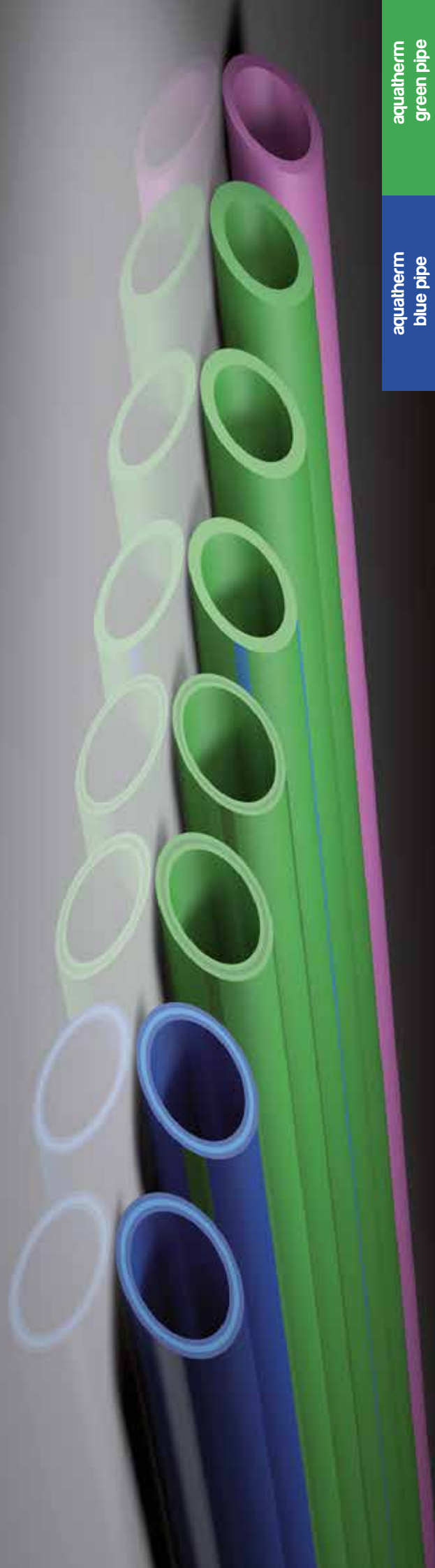



aquatherm  
state of the pipe

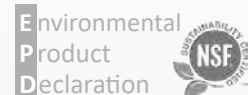

# EVOLUCIÓN PERFECTA

aquatherm green pipe SDR 9 MF RP

## PP-RP

[Beta (β) PP-RCT]

La evolución del PPR  
en instalaciones de  
**agua caliente sanitaria**  
mejora el comportamiento a  
presión y temperatura elevada

Campos de



aquatherm green pipe SDR 9 MF RP

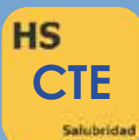

## AGUA POTABLE



## aquatherm green pipe - SERIE 4 - SDR 9 MF RP

Estructura de la tubería: MF = Multicapa, con refuerzo de fibra (FASER)  
 Material: fusiolen® PP-RCT (Beta  $\beta$  PP-RCT)\*  
 Serie: Serie 3,2 /SDR 7,4 y Serie 4 / SDR 9  
 Normativa: SKZHR 3.28, ASTM F 2389, CSA B 137.11, ISO 21003  
 RP01.78, RP01.72  
 Color: verde con 4 franjas verde oscuro  
 Forma de suministro:  $\varnothing$  20-125mm barras de 4 m  
 $\varnothing$  160-355mm barras de 5,8 m

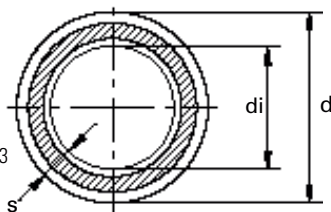

Ud. de suministro: m metros

Aplicaciones:



Estabilizada mediante una mezcla de fi-

SDR	Art.-No.	Dimensión d [mm]	Espesor de pared s [mm]	Diámetro interior di [mm]	Capacidad [l/m]	Peso [kg]	DN	Uds./Paquete [m]	Precio € m/pc	
7,4	1012020506	20	2,8	14,4	0,163	0,159	15	100	2,85	
	1012025508	25	3,5	18,0	0,254	0,247	20	100	4,03	
Soldadura a enchufe										
9	1013032010	32	3,6	24,8	0,483	0,328	25	40	6,62	
	1013040012	40	4,5	31,0	0,754	0,511	32	40	11,17	
	1013050014	50	5,6	38,8	1,182	0,791	40	20	16,34	
	1013063016	63	7,1	48,8	1,869	1,261	50	20	22,02	
	1013075018	75	8,4	58,2	2,659	1,771	-	20	34,68	
	1013090020	90	10,1	69,8	3,825	2,553	65	12	49,03	
	1013110022	110	12,3	85,4	5,725	3,789	80	8	68,37	
	1013125024	125	14,0	97,0	7,386	4,886	100	4	85,09	
	Soldadura a tope									
		1013160026	160	17,9	124,2	12,109	7,987	125	5,8	173,29
		1013200028	200	22,4	155,2	18,908	12,489	150	5,8	264,37
		1013250030	250	27,9	194,2	29,605	19,423	200	5,8	412,03
	1013315032	315	35,2	244,6	46,966	30,877	250	5,8	691,43	

\* Referencias 1012020506 a 1012025508 fabricadas con materia prima fusiolen PP-R

## aquatherm green pipe - SERIE 3,2 / SDR 7,4 MF

Disponible bajo demanda, durante 2021 se irá reduciendo el stock progresivamente



SDR	Art.-No.	Dimensión d [mm]	Espesor de pared s [mm]	Diámetro interior di [mm]	Capacidad [l/m]	Peso [kg]	DN	Uds/paquete [m]	Precio € m/pc
Soldadura a enchufe									
7,4	1012020506	20	2,8	14,4	0,163	0,159	15	100	2,85
	1012025508	25	3,5	18,0	0,254	0,247	20	100	4,03
	1012032510	32	4,4	23,2	0,423	0,395	25	40	6,80
	1012040512	40	5,5	29,0	0,660	0,610	32	40	11,48
	1012050514	50	6,9	36,2	1,029	0,950	40	20	16,84
	1012063516	63	8,6	45,8	1,647	1,490	50	20	22,71
	1012075518	75	10,3	54,4	2,323	2,115	-	20	35,68
	1012090520	90	12,3	65,4	3,358	3,030	65	12	50,53
	1012110522	110	15,1	79,8	4,999	4,530	80	8	70,37
	1012125524	125	17,1	90,8	6,472	6,211	-	4	87,58
Soldadura a tope									
-	160-355	Dimensiones 160 a 315 mm ver aquatherm green pipe SDR 9 MF RP							

**Nota importante: MF = Multicapa FASER**

**aquatherm green pipe - SERIE 3,2 / 4 - SDR 7,4 MF/ 9 MF RP UV**

Estructura de la tubería: MF = Multicapa, con refuerzo de fibra (FASER)  
 Característica especial: RP (aumento de la resistencia a la presión), UV (resistencia a rayos UV)  
 Material: fusiolen® PP-RCT  
 Serie: Serie 3,2 /SDR 7,4 y Serie 4 / SDR 9  
 Normativa: SKZ HR 3.28, ASTM F 2389, ISO 21003. RP01.78  
 Color: capas internas: verde  
 capa exterior: negra  
 Forma de suministro: ø 32-125mm barras de 4 m  
 ø 160-355mm barras de 5,8 m  
 Ud. de suministro: en metros  
 Aplicaciones:

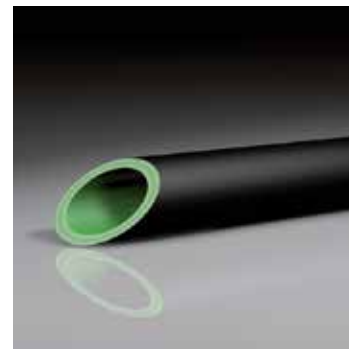
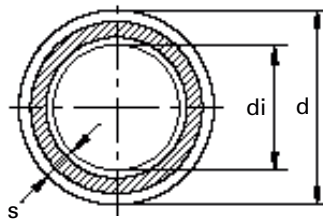

Resistente a rayos UV. Estabilizada mediante una mezcla de fibra de vidrio integrada como una capa intermedia en el material fusiolen® PP-RCT.

SDR	Art.-No.	Dimensión d [mm]	Espesor de pared s [mm]	Diámetro interior di [mm]	Capacidad [l/m]	Peso [kg]	DN	Uds./Paquete [m]	Precio € m/pc
7,4	Soldadura a enchufe								
	1212020006	20	2,8	14,4	0,163	0,211	15	100	4,37
	1212025008	25	3,5	18,0	0,254	0,316	20	100	6,30
9	1213032010	32	3,6	24,8	0,483	0,388	25	40	9,67
	1213040012	40	4,5	31,0	0,754	0,588	32	40	14,97
	1213050014	50	5,6	38,8	1,182	0,891	40	20	23,33
	1213063016	63	7,1	48,8	1,869	1,391	50	20	33,12
	1213075018	75	8,4	58,2	2,659	1,908	-	20	48,10
	1213090020	90	10,1	69,8	3,825	2,746	65	12	69,93
	1213110022	110	12,3	85,4	5,725	4,116	80	8	91,58
	1213125024	125	14,0	97,0	7,386	5,287	100	4	116,96
	Soldadura a tope								
		1213160026	160	17,9	124,2	12,109	8,466	125	5,8
	1213200028	200	22,4	155,2	18,908	13,087	150	5,8	285,89

**Nota Importante: MF = Multicapa FASER**



**aquatherm green pipe - SERIE 2,5 / SDR 6 S**

Estructura de la tubería: S (monocapa)  
 Material: fusiolen® PP-R  
 Serie: SDR 6/S 2,5  
 Normativa: DIN 8077, DIN 8078, UNE EN ISO 15874, ASTM F 2389, CSA B 137.11  
 Color: verde  
 Forma de suministro: barras de 4 m, \*disponible en rollos  
 Ud. de suministro: en metros  
 Aplicaciones:

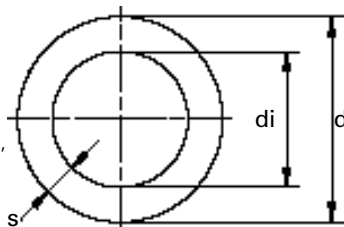

SDR	Art.-No.	Dimensión d [mm]	Espesor de pared s [mm]	Diámetro interior di [mm]	Capacidad [l/m]	Peso [kg]	DN	Uds./Paquete [m]	Precio € m/pc
6	1011016003	16	2,7	10,6	0,088	0,111	10	100	1,81
	1011020006	20	3,4	13,2	0,137	0,171	12	100	2,25
	1011025008	25	4,2	16,6	0,216	0,266	15	100	3,72
	1011032010	32	5,4	21,2	0,353	0,428	20	40	6,24
	1011040012	40	6,7	26,6	0,555	0,660	25	40	10,67
	1011050014	50	8,3	33,4	0,876	1,054	32	20	14,74
	1011063016	63	10,5	42,0	1,385	1,697	40	20	21,88
	1011075018	75	12,5	50,0	1,963	2,328	50	20	37,66
	1011090020	90	15,0	60,0	2,826	3,415	60	12	54,82
	1011110022	110	18,3	73,4	4,229	5,150	65	8	87,57
	1011016303*	16	2,7	10,6	0,088	0,012	10	100	1,81
	1011020306*	20	3,4	13,2	0,137	0,172	12	100	2,25
	1011025308*	25	4,2	16,6	0,216	0,260	15	100	3,72

**aquatherm green pipe - SERIE 3,2 / SDR 7,4 S**

Estructura de la tubería: S (monocapa)  
 Material: fusiolen® PP-R  
 Serie: SDR 6/S 2,5 & SDR 7,4/S 3,2  
 Normativa: DIN 8077, DIN 8078, UNE EN ISO 15874, ASTM F 2389, CSA B 137.11  
 Color: verde  
 Forma de suministro: barras de 4 m, \*disponible en rollos  
 Ud. de suministro: en metros  
 Aplicaciones:

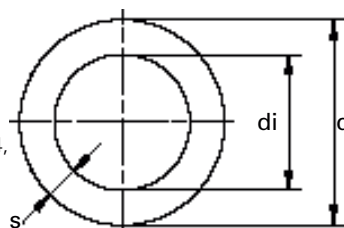

SDR	Art.-No.	Dimensión d [mm]	Espesor de pared s [mm]	Diámetro interior di [mm]	Capacidad [l/m]	Peso [kg]	DN	Uds./Paquete [m]	Precio € m/pc
7,4	1012016003	16	2,2	11,6	0,106	0,098	12	100	1,57
	1012020006	20	2,8	14,4	0,163	0,152	15	100	1,93
	1012025008	25	3,5	18,0	0,254	0,235	20	100	3,25
	1012032010	32	4,4	23,2	0,423	0,375	25	40	5,24
	1012040012	40	5,5	29,0	0,660	0,580	32	40	8,42
	1012050014	50	6,9	36,2	1,029	0,905	40	20	13,41
	1012063016	63	8,6	45,8	1,647	1,420	50	20	19,15
	1012016303*	16	2,2	11,6	0,106	0,100	12	100	1,57
	1012020306*	20	2,8	14,4	0,163	0,149	15	100	1,93

# TUBERÍAS

## aquatherm green pipe - SERIE 5 / SDR 11 S AGUA FRIA

Estructura de la tubería: S (monocapa) - MF para DN400-450

Material: fusiolen® PP-R

Serie: SDR 11/S5

Normativa: DIN 8077/78, UNE EN ISO 15874, ASTM F 2389, CSA B 137.11

Color: verde con 4 rayas azules

Forma de suministro: ø 20-125mm barras de 4 m, \*disponible en rollos  
ø 160-450mm barras de 5,8 m

Ud. de suministro: en metros

Aplicaciones:

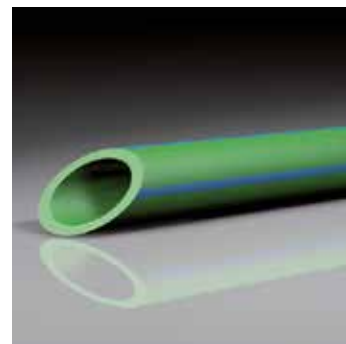
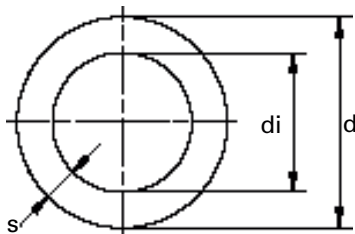

SDR	Art.-No.	Dimensión d [mm]	Espesor de pared s [mm]	Diámetro interior di [mm]	Capacidad [l/m]	Peso [kg]	DN	Uds./Paquete [m]	Precio € m/pc
11	Soldadura a enchufe								
	1014020006	20	1,9	16,2	0,206	0,109	15	100	1,82
	1014025008	25	2,3	20,4	0,327	0,165	20	100	2,68
	1014032010	32	2,9	26,2	0,539	0,265	25	40	4,12
	1014040012	40	3,7	32,6	0,834	0,415	32	40	7,36
	1014050014	50	4,6	40,8	1,307	0,645	40	20	11,42
	1014063016	63	5,8	51,4	2,074	1,015	50	20	16,22
	1014075018	75	6,8	61,4	2,959	1,415	65	20	23,95
	1014090020	90	8,2	73,6	4,252	2,045	80	12	32,81
	1014110022	110	10,0	90,0	6,359	3,136	-	8	50,78
	1014125024	125	11,4	102,2	8,199	3,927	100	4	63,50
	1014020306*	20	1,9	16,2	0,206	0,109	15	100	1,82
	1014025308*	25	2,3	20,4	0,327	0,158	20	100	2,68
	1014032310*	32	2,9	26,2	0,539	0,257	25	50	4,12
	Soldadura a tope								
	1014160026	160	14,6	130,8	13,430	6,416	125	5,8	116,84
1014200028	200	18,2	163,6	21,010	9,991	150	5,8	197,25	
1014250030	250	22,7	204,6	32,861	15,540	200	5,8	292,69	
1014315032	315	28,6	257,8	52,172	25,700	250	5,8	419,95	

# aquatherm blue pipe MF RP

N  
U  
E  
V  
O

# PPRP

## LA SIGUIENTE GENERACIÓN DE TUBERÍAS DE POLIPROPILENO MEJOR RESISTENCIA A PRESIÓN Y TEMPERATURA ELEVADA.

El nuevo **aquatherm blue pipe MF RP** mejora sus prestaciones trabajando a presión y temperatura elevada, siendo un sistema duradero y resistente a la corrosión. El sistema fabricado con fusiolen® PP-RCT se adapta a la perfección a las condiciones demandadas por el mercado de HVAC.

**aquatherm blue pipe MF RP** mejora sus prestaciones anteriores de uso respecto al transporte de fluidos a presión y temperatura elevadas, pudiendo alcanzar ahora requerimientos superiores en instalaciones, siendo así un sistema mucho más competitivo.

### Presiones de Servicio: Comparativa entre PPR y PPRCT para 50 años de servicio\*

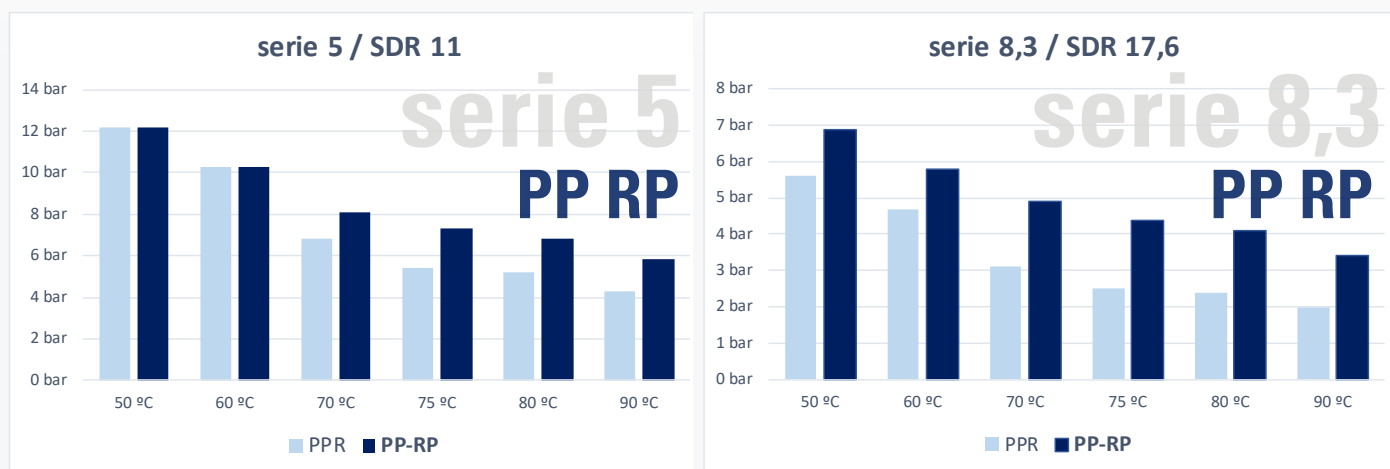

\*80°C 25 años y 90°C 10 años

### Dimensiones

20mm 25mm 32mm 40mm 50mm 63mm 75mm 90mm 110mm 125mm 160mm 200mm 250mm 315mm 355mm 400mm 450mm 500mm 560mm 630mm

### Campos de aplicación

- Calefacción
- Climatización
- Suelo Radiante
- Refrigeración Superficie Industrial
- Calefacción Superficie Industrial
- Agua Refrigerada
- Agricultura
- Riego
- Sup. Deportivas
- Piscinas
- Transporte Productos Químicos
- Industria Naval
- Distric Heating & Cooling
- Geotermia



**aquatherm blue pipe - SERIE 3,2 / 5 / 8,3 - SDR 7,4 / 11 / 17,6 MF RP**

Estructura de la tubería: MF = Multicapa, con refuerzo de fibra (FASER)

Material: fusiolen® PP-RCT

Serie: SDR 7,4/S 3,2 & SDR11 / S 5 & SDR 17,6 / S 8,3

Normativa: SKZ HR 3.28, ASTM F 2389, CSA B 137.11, ISO 21003, RP 01.78

Color: azul

Forma de suministro: ø 20-125mm barras de 4 m  
ø 160-630mm barras de 5,8 m

Ud. de suministro: en metros

Aplicaciones:

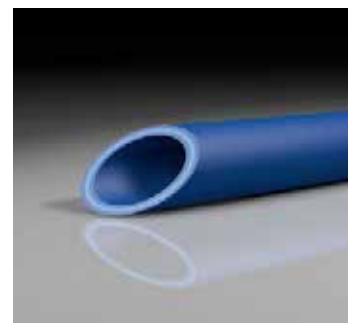
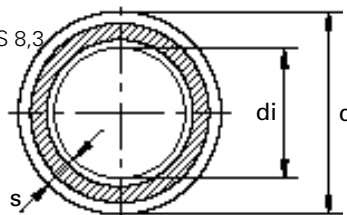

Estabilizada mediante una mezcla de fibra de vidrio integrada como una capa intermedia en el material fusiolen® PP-RCT.

SDR	Art.-No.	Dimensión d [mm]	Espesor de pared s [mm]	Diámetro interior di [mm]	Capacidad [l/m]	Peso [kg]	DN	Uds./Paquete [m]	Precio € m/pc
7,4	Soldadura a enchufe								
	2012020006	20	2,8	14,4	0,163	0,159	15	100	2,56
	2012025008	25	3,5	18,0	0,254	0,244	20	100	3,81
9	2013032010	32	3,6	24,8	0,483	0,328	25	40	5,18
11	2014040012	40	3,7	32,6	0,834	0,435	32	40	8,36
	2014050014	50	4,6	40,8	1,307	0,675	40	20	11,67
	2014063016	63	5,8	51,4	2,074	1,065	50	20	17,78
	2014075018	75	6,8	61,4	2,959	1,482	65	20	23,08
	2014090020	90	8,2	73,6	4,252	2,145	80	12	34,18
	2014110022	110	10,0	90,0	6,359	3,175	-	8	50,34
	2014125024	125	11,4	102,2	8,199	4,118	100	4	58,20
	Soldadura a tope								
	2014160026	160	14,6	130,8	13,430	6,728	125	5,8	114,34
	2014200028	200	18,2	163,6	21,010	10,480	150	5,8	193,38
	2014250030	250	22,7	204,6	32,861	16,300	200	5,8	301,74
2014315032	315	28,6	257,8	52,172	25,700	250	5,8	496,30	
2014355034	355	32,2	290,6	66,29	33,034	300	5,8	580,02	
2014400036	400	36,3	327,6	84,290	41,400	300	5,8	790,99	
2014450038	450	40,9	368,2	106,477	52,400	400	5,8	1.113,50	
17,6	Soldadura a enchufe								
	2017125224	125	7,1	110,8	9,637	2,698	100	4	53,34
	Soldadura a tope								
	2017160026	160	9,1	141,8	15,792	4,360	150	5,8	81,97
	2017200028	200	11,4	177,2	24,661	6,800	200	5,8	131,81
	2017250030	250	14,2	221,6	38,568	10,570	250	5,8	189,01
	2017315032	315	17,9	279,2	61,223	16,740	300	5,8	281,59
	2017355034	355	20,1	314,8	77,832	21,210	350	5,8	372,04
	2017400036	400	22,7	354,6	98,756	26,930	350	5,8	476,15
	2017450038	450	25,5	399,0	125,036	34,020	400	5,8	615,26
2017500040	500	28,4	443,2	154,272	42,070	450	5,8	776,33	
2017630042	630	35,7	558,6	245,070	66,540	500	5,8	1.404,07	

**Nota Importante: MF = Multicapa FASER**

**aquatherm blue pipe - SERIE 3,2 / 5 / 8,3 - SDR 7,4/11/17,6 MF RP UV**

Estructura de la tubería: MF =Multicapa, con refuerzo de fibra (FASER)

Característica: UV (resistencia a rayos UV)

Material: fusiolen® PP-RCT

Serie: SDR 7,4/S 3,2 &amp; SDR11/SDR 17,6 / S 8,3

Normativa: SKZ HR 3.28, ASTM F 2389, CSA B 137.11, ISO 21003, RP 01.78

Color: exterior: negro, interior: azul

Forma de suministro: ø 20-125mm barras de 4 m  
ø 160-250mm barras de 5,8 m

Ud. de suministro: en metros

Aplicaciones:

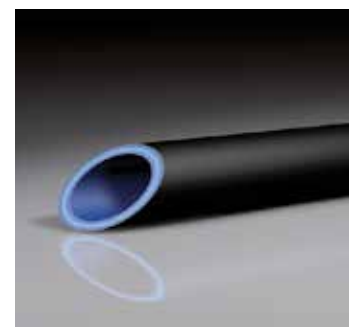
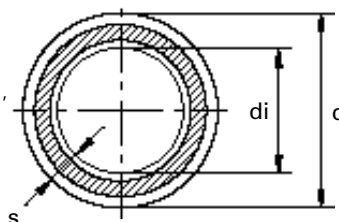

Resistente a rayos UV.

Estabilizada mediante una mezcla de fibra de vidrio integrada como una capa intermedia en el material fusiolen® PP-RCT.

SDR	Art.-No.	Dimensión d [mm]	Espesor de pared s [mm]	Diámetro interior di [mm]	Capacidad [l/m]	Peso [kg]	DN	Uds./Paquete [m]	Precio € m/pc
Soldadura a enchufe									
7,4	2212020006	20	2,8	14,4	0,163	0,209	15	100	3,80
	2212025008	25	3,5	18,0	0,254	0,313	20	100	5,74
9	2213032010	32	3,6	24,8	0,483	0,328	20	40	9,17
11	2214040012	40	3,7	32,6	0,834	0,554	32	40	11,17
	2214050014	50	4,6	40,8	1,307	0,825	40	20	16,22
	2214063016	63	5,8	51,4	2,074	1,257	50	20	25,26
	2214075018	75	6,8	61,4	2,959	1,707	65	20	33,62
	2214090020	90	8,2	73,6	4,252	2,483	80	12	50,09
	2214110022	110	10,0	90,0	6,359	3,688		8	76,73
	2214125024	125	11,4	102,2	8,199	4,673	100	4	94,57
	Soldadura a tope								
11	2214160026	160	14,6	130,8	13,430	7,512	125	5,8	165,43
	2214200028	200	18,2	163,6	21,010	11,411	150	5,8	258,26
	2214250030	250	22,7	204,6	32,861	17,754	200	5,8	397,81
	2214315032	315	28,6	257,8	52,172	26,619	250	5,8	639,15
	2214355034	355	32,2	290,6	66,292	33,668	300	5,8	776,08
	2214400036	400	36,3	327,4	84,145	42,566	300	5,8	1.056,55
	2214450038	450	40,9	368,2	106,423	53,709	400	5,8	1.460,90
	2217160026	160	9,1	141,8	15,784	4,839	150	5,8	127,82
17,6	2217200028	200	11,4	177,2	24,649	7,396	200	5,8	221,76
	2217250030	250	14,2	221,6	38,549	11,321	250	5,8	319,58
	2217315032	315	17,9	279,2	61,193	17,676	300	5,8	477,21
	2217355034	355	20,1	314,8	77,793	22,266	350	5,8	600,04
	2217400036	400	22,7	354,6	98,707	28,124	350	5,8	763,04
	2217450038	450	25,5	399	124,973	35,364	400	5,8	979,38
	2217500040	500	28,4	443,2	154,195	43,563	450	5,8	1.245,75
	2217630042	630	35,7	558,6	244,947	68,420	500	5,8	2.367,48

**aquatherm blue pipe - SERIE 3,2/5 - SDR 7,4/11 MF RP OT**

Estructura de la tubería: MF =Multicapa, con refuerzo de fibra (FASER)  
 Característica: OT = barrera antidifusora de oxígeno  
 Material: fusiolen® PP-RCT  
 Serie: SDR 7,4/S 3,2 & SDR11 / S 5  
 Normativa: DIN 8077/78, ASTM F 2389, CSA B 137.11, ISO 21003, DIN 4726, RP01.78  
 Color: azul brillante  
 Forma de suministro: ø 20-125mm barras de 4 m  
 ø 160-250mm barras de 5,8 m  
 Ud. de suministro: en metros  
 Aplicaciones:

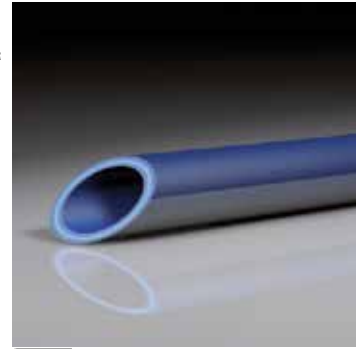
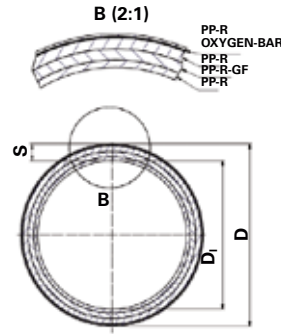

Con barrera antidifusora de oxígeno.  
 Estabilizada mediante una mezcla de fibra de vidrio integrada como una capa intermedia en el material fusiolen® PP-RCT.

SDR	Art.-No.	Dimensión d [mm]	Espesor de pared s [mm]	Diámetro interior di [mm]	Capacidad [l/m]	Peso [kg]	DN	Uds./Paquete [m]	Precio € m/pc
Soldadura a enchufe									
7,4	2112020006	20	2,8	14,4	0,163	0,199	15	100	2,99
	2112025008	25	3,5	18,0	0,254	0,299	20	100	4,55
9	2113032010	32	3,6	24,8	0,483	0,328	20	40	8,17
11	2114040012	40	3,7	32,6	0,834	0,530	32	40	9,29
	2114050014	50	4,6	40,8	1,307	0,794	40	20	13,41
	2114063016	63	5,8	51,4	2,074	1,218	50	20	22,27
	2114075018	75	6,8	61,4	2,959	1,649	65	20	28,70
	2114090020	90	8,2	73,6	4,252	2,379	80	12	41,10
	2114110022	110	10	90,0	6,359	3,550		8	62,63
	2114125024	125	11,4	102,2	8,199	4,576	100	4	73,36
	Soldadura a tope								
	2114160026	160	14,6	130,8	13,430	7,284	125	5,8	130,25
	2114200028	200	18,2	163,6	21,010	11,000	150	5,8	196,31
	2114250030	250	22,7	204,6	32,861	16,700	200	5,8	299,05

**NOTA:** Es imprescindible pelar la tubería antes de soldar. Peladores en la página 104-105.  
**NO** es compatible con elementos **electrosoldables** para **DN160, DN200 y DN250**.

**aquatherm blue pipe - SERIE 5 / SDR 11 S**

Estructura de la tubería: S (monocapa)  
 Material: fusiolen® PP-R  
 Serie: SDR 11/S 5  
 Normativa: DIN 8077/78, UNE EN ISO 15874, ASTM F 2389, CSA B 137.11, NSF 14  
 Color: azul  
 Forma de suministro: barras de 4 m, \*disponible en rollos  
 Ud. de suministro: en metros  
 Aplicaciones:

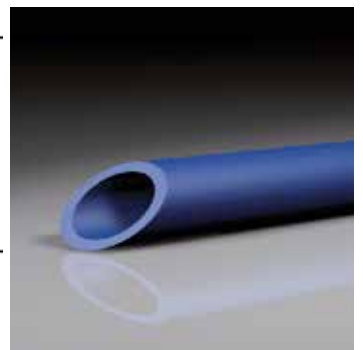
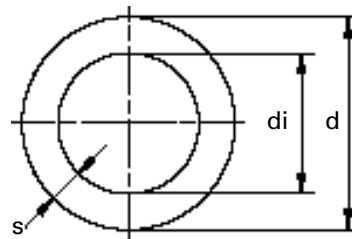

SDR	Art.-No.	Dimensión d [mm]	Espesor de pared s [mm]	Diámetro interior di [mm]	Capacidad [l/m]	Peso [kg]	DN	Uds./Paquete [m]	Precio € m/pc
	2014020306*	20	1,9	16,2	0,206	0,107	15	100	2,12
	2014025308*	25	2,3	20,4	0,327	0,164	20	100	2,86
	2014032310*	32	2,9	26,2	0,539	0,257	25	50	4,74

**Nota importante: MF = Multicapa FASER**

# aquatherm blue pipe SDR 11 MF OT con barrera anti-difusora de oxígeno



El complemento indispensable para la distribución en instalaciones de **superficies radiantes**.

La solución perfecta para la protección de calderas, intercambiadores

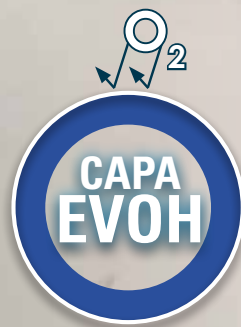

**MPA NRW.**  
Materialprüfungsamt Nordrhein-Westfalen  
PRUFEN ÜBERWACHEN ZERTIFIZIEREN



$I(O_2) = 0,0024 \text{ g}/(\text{m}^2\text{d})$

**ABRAZADERAS AQUATHERM**

Aptas para realizar puntos fijos y deslizantes.

Conexión roscada: M8 & M10 para 16 - 125 mm | M10 para 160 mm | M16 para 200 - 355 mm

Art.-No.	para tubería de dimensión	Uds./Paquete	Uds./Caja	Precio € m/pc
9600060516	16 mm	50	500	2,35
9600060520	20 mm	50	200	2,56
9600060525	25 mm	50	200	2,68
9600060532	32 mm	50	200	2,93
9600060540	40 mm	50	150	3,25
9600060550	50 mm	50	150	3,49
9600060563	63 mm	25	100	5,12
9600060575	75 mm	25	100	5,99
9600060590	90 mm	25	75	6,30
9600060594	110 mm	25	50	7,55
9600060595	125 mm	25	50	9,17
9600060597	160 mm	25	25	10,98
9600060650	200 mm	1	18	42,23
9600060654	250 mm	1	12	49,41
9600060658	315 mm	1	3	72,61
9600060660	355 mm	1	3	82,72



**ABRAZADERAS MÜPRO OPTIMAL**

Art.-No.	para tubería de dimensión	Uds./Paquete	Uds./Caja	Precio € m/pc
119902	16 mm	50		3,05
119906	20 mm	50		3,12
119910	25 mm	50		3,62
119914	32 mm	50		3,81
119918	40 mm	50		3,99
119922	50 mm	50		4,30
119930	63 mm	25		4,80
119938	75 mm	25		7,55
119942	90 mm	25		8,48
119934	110 mm	25		9,98
119279	125 mm	25		11,42
119291	160 mm	25		15,60



**ABRAZADERAS**

Aptas para realizar puntos fijos.

Art.-No.	Dimensiones	Uds / paquete	Precio € m/pc
9600060768	160 mm	1	804,71
9600060770	200 mm	1	904,52
9600060774	250 mm	1	1.079,19
9600060778	315 mm	1	1.135,33
9600060780	355 mm	1	1.166,52
9600060782	400 mm	1	1.422,29
9600060784	450 mm	1	1.515,86
9600060786	500 mm	1	1.572,00
9600060790	630 mm	1	1.690,53



**ABRAZADERAS DE FIJACIÓN PLÁSTICAS**

para tuberías de ø 16 - 40 mm

Art.-No.	para tubería de dimensión	Uds./Paquete	Uds./Caja	Precio € m/pc
7090016010	16 mm	50	3000	0,34
7090020011	20 mm	50	3000	0,47
7090025012	25 mm	30	1500	0,71
7090032013	32 mm	30	900	1,90
7040040014	40 mm	30		1,99





### ABRAZADERA DE PA VÁLIDA PARA TUBERÍAS

para tuberías de  $\varnothing$  16 - 32 mm

Art.-No.	para tubería de dimensión	Uds./Paquete	Uds./Caja	Precio € m/pc
7020016005	simple - Longitud = 45 mm	50	4000	0,52
7020016006	simple - Longitud = 75 mm	50	3000	0,59
7020016007	doble - Longitud = 45 mm	50	2500	0,63
7020016008	doble - Longitud = 75 mm	50	1750	0,71

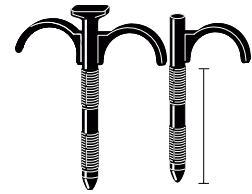

### MANGUITO

Sistemas: **aquatherm green pipe,**  
**aquatherm blue pipe**  
Material: Fusiolen® PP-R  
Normas: DIN 16962, UNE EN ISO 15874  
Color: verde

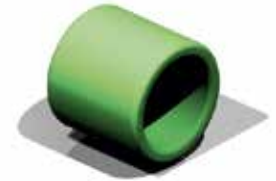
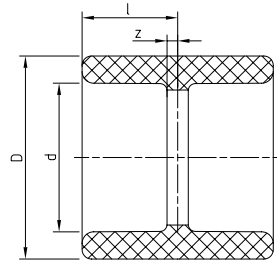

SDR	Art.-No.	Dimensión d [mm]	l	z	D	Peso [kg]	Sistemas	Uds./Paquete	Uds./Caja	Precio € m/pc
6 7,4 9 11 17,6	1040016001	16	15,00	2,00	24,50	0,008	• • •	10	2000	0,56
	1040020002	20	16,00	1,50	29,50	0,011	• • •	10	1500	0,62
	1040025003	25	17,50	1,50	34,00	0,014	• • •	10	1000	0,76
	1040032004	32	20,25	2,25	43,00	0,026	• • •	5	600	1,15
	1040040005	40	23,75	3,25	52,00	0,044	• • •	5	400	1,97
	1040050006	50	26,50	3,00	68,00	0,084	• • •	5	200	3,40
	1040063007	63	30,25	2,75	84,00	0,139	• • •	1	100	6,03
	1040075008	75	33,25	3,25	100,00	0,226	• • •	1	70	8,52
	1040090009	90	36,25	3,25	120,00	0,343	• • •	1	50	16,16
	1040110010	110	41,00	4,00	147,00	0,583	• • •	1	30	24,56
1040125011	125	45,00	5,00	167,00	0,844	• • •	1	25	35,31	

### REDUCCIÓN HEMBRA/HEMBRA

Sistemas: **aquatherm green pipe,**  
**aquatherm blue pipe**  
Material: Fusiolen® PP-R  
Normas: DIN 16962, UNE EN ISO 15874  
Color: verde

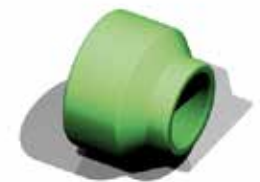
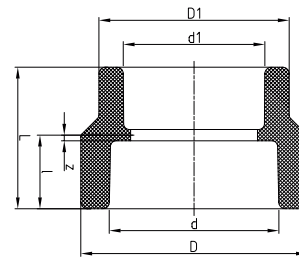

SDR	Art.-No.	Dimensión d [mm]	Dimensión d1 [mm]	L	l	z	D	D1	Peso [kg]	Sistemas	Uds./Paquete	Uds./Caja	Precio € m/pc
ambas caras - Soldadura a enchufe													
6 7,4 9 11 17,6	1040040073	40	32	44,00	24,00	3,50	52,00	43,00	0,050	• • •	1	40	4,55
	1040050074	50	32	47,00	26,50	3,00	68,00	43,00	0,093	• • •	1	25	6,86
	1040050075	50	40	50,50	26,50	3,00	68,00	52,00	0,098	• • •	1	100	6,86
	1040063076	63	40	54,00	30,50	3,00	84,00	52,00	0,163	• • •	1	100	9,23
	1040063077	63	50	56,00	30,00	2,50	84,00	68,00	0,171	• • •	1	100	12,91
	1040075078	75	50	60,00	33,50	3,50	100,00	68,00	0,258	• • •	1	80	11,79
	1040075079	75	63	62,50	32,50	2,50	100,00	84,00	0,268	• • •	1	80	14,22
	1040090080	90	63	66,50	36,50	3,50	120,00	84,00	0,414	• • •	1	50	24,89
	1040090081	90	75	69,00	36,00	3,00	120,00	100,00	0,430	• • •	1	50	22,02
	1040110082	110	75	74,50	41,00	4,00	147,00	100,00	0,733	• • •	1	45	34,87
1040110083	110	90	77,50	41,00	4,00	147,00	120,00	0,729	• • •	1	35	34,87	
1040125084	125	90	83,00	46,00	6,00	167,00	120,00	1,075	• • •	1	25	47,10	
1040125085	125	110	87,00	46,00	6,00	167,00	147,00	1,090	• • •	1	20	51,21	

## ACCESORIOS DE PP-R SIMPLES

### IMPRIMACIÓN PP AQUATHERM

para tuberías de PP de aquatherm

Art.-No..	Dimensión	Uds.	Precio € m/pc
9700050230		1l	164,78
9700050231		10l	1.353,55



### PINTURA ESPECIAL PP AQUATHERM

para tuberías de PP de aquatherm

Art.-No..	Dimension	Uds.	Price € m/pc
9700050232	Negro	2,5l	76,51
9700050233	Blanco	2,5l	76,51



**NOTA:** Disponible en otros colores y con protección UV.

### REDUCCIÓN MACHO/HEMBRA

Sistemas: **aquatherm green pipe,**  
**aquatherm blue pipe**  
Material: Fusiolen® PP-R  
Normas: DIN 16962, UNE EN ISO 15874  
Color: verde

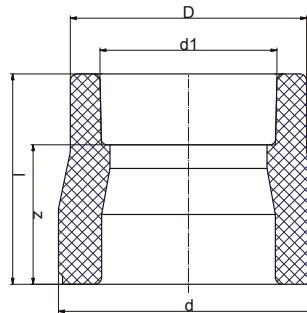

SDR	Art.-No.	Dimensión d [mm] MACHO	Dimensión d1 [mm] HEMBRA	l	z	D	Peso [kg]	Sistemas	Uds./Paquete	Uds./Caja	Precio € m/pc
ambas caras - Soldadura a enchufe											
6 7,4 9 11 17,6	1040020020	20	16	39,00	26,00	24,50	0,009	•	10	2000	0,61
	1040025021	25	16	38,00	25,00	26,00	0,012	•	10	2000	0,82
	1040025022	25	20	38,50	24,00	29,50	0,012	• • •	10	1500	0,82
	1040032023	32	20	37,50	23,00	29,50	0,015	• • •	5	1000	1,09
	1040032024	32	25	38,00	22,00	34,00	0,016	• • •	5	1000	1,09
	1040040025	40	20	45,00	30,50	29,50	0,025	• • •	5	750	2,10
	1040040026	40	25	50,00	34,00	34,00	0,028	• • •	5	600	2,10
	1040040027	40	32	50,00	32,00	43,00	0,032	• • •	5	500	2,10
	1040050028	50	20	55,00	40,50	29,50	0,045	• • •	5	500	3,49
	1040050029	50	25	55,00	39,00	34,00	0,044	• • •	5	500	3,49
	1040050030	50	32	54,00	36,00	43,00	0,048	• • •	5	350	3,49
	1040050031	50	40	52,50	32,00	52,00	0,053	• • •	5	300	3,49
	1040063032	63	20	65,00	50,50	29,50	0,073	• • •	1	200	6,04
	1040063033	63	25	65,00	49,00	34,00	0,071	• • •	1	200	6,04
	1040063034	63	32	62,00	44,00	43,00	0,076	• • •	1	200	6,04
	1040063035	63	40	65,00	44,50	52,00	0,089	• • •	1	200	6,04
	1040063036	63	50	63,50	40,00	68,00	0,107	• • •	1	150	6,04
	1040075037	75	40	69,50	49,00	52,00	0,130	• • •	1	150	7,98
	1040075038	75	50	63,00	39,50	68,00	0,141	• • •	1	100	7,98
	1040075039	75	63	71,00	43,50	84,00	0,171	• • •	1	100	7,98
	1040075040	75	20	65,50	51,00	34,50	0,115	• • •	1	200	7,98
1040075041	75	25	65,50	49,50	34,50	0,109	• • •	1	200	7,98	
1040075042	75	32	69,50	51,50	52,00	0,140	• • •	1	150	7,98	
1040090043	90	50	75,00	51,50	68,00	0,196	• • •	1	100	16,41	
1040090044	90	63	78,00	50,50	84,00	0,226	• • •	1	75	16,41	
1040090045	90	75	81,50	51,50	100,00	0,272	• • •	1	60	16,41	
1040110046	110	63	86,00	58,50	84,00	0,356	• • •	1	50	30,88	
1040110047	110	75	89,00	59,00	100,00	0,383	• • •	1	50	30,88	
1040110048	110	90	99,00	66,00	120,00	0,502	• • •	1	40	30,88	
1040125049	125	75	101,00	71,00	100,00	0,528	• • •	1	35	38,55	
1040125050	125	90	99,00	66,00	120,00	0,588	• • •	1	35	40,17	
1040125051	125	110	112,00	75,00	147,00	0,833	• • •	1	25	41,04	

**REDUCCIÓN - SOLDADURA A ENCHUFE & SOLDADURA A TOPE**

Sistemas: **aquatherm green pipe, aquatherm blue pipe**  
 Material: Fusiolen® PP-R  
 Normas: DIN 16962, UNE EN ISO 15874  
 Color: verde

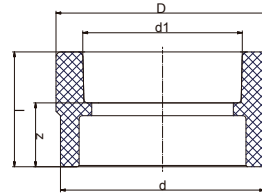

SDR	Art.-No.	Dimensión d [mm]	Dimensión d1 [mm]	l	z	D	Peso [kg]	Sistemas	Uds./Paquete	Uds./Caja	Precio € m/pc	
un lado soldadura a enchufe, el otro lado soldadura a tope												
9	1043160122	160	110	87,00	50,00	147,00	0,669	•		1	55,52	
	1043160123	160	125	90,00	50,00	167,00	0,754	•		1	64,63	
	1043200124	200	125	135,00	95,00	167,00	1,453	•		1	77,73	
11	1044160053	160	110	90,00	53,00	147,00	0,595	• •		1	25	48,41
	1044160055	160	125	90,00	50,00	167,00	0,705	• •		1	20	59,57
	1044200057	200	125	135,00	95,00	167,00	1,358	• •		1		66,68
17,6	2047160001	160	110	90,00	53,00	147,00	0,618		•	1	25	45,41
	2047160002	160	125	90,00	50,00	167,00	0,628		•	1	25	60,57
	2047200003	200	125	135,00	95,00	167,00	1,055		•	1		63,19

\*Para elementos de electrosoldadura ver página 43

**REDUCCIÓN, SOLDADURA A TOPE**

Sistemas: **aquatherm green pipe, aquatherm blue pipe**  
 Material: Fusiolen® PP-R  
 Normas: DIN 16962, UNE EN ISO 15874  
 Color: verde

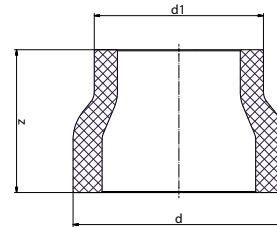

SDR	Art.-No.	Dimensión d [mm]	Dimensión d1 [mm]	z	Peso [kg]	Sistemas	Uds./Paquete	Uds./Caja	Precio € m/pc
ambas caras - Soldadura a tope									
9	1043200125	200	160	135,00	1,329	•		1	91,76
	1043250126	250	160	172,50	2,419	•		1	98,31
	1043250127	250	200	172,50	2,623	•		1	124,57
	1043315128	315	250	225,00	5,382	•		1	216,27
11	1044200059	200	160	135,00	1,163	• •		1	85,21
	1044250061	250	160	172,50	3,472	• •		1	94,38
	1044250063	250	200	172,50	2,341	• •		1	117,97
	1044315064	315	200	225,00	3,412	• •		1	190,07
	1044315065	315	250	233,00	4,650	• •		1	199,93
	1044355066	355	250	245,00	3,940	• •		1	223,64
	1044355067	355	315	160,00	4,344	• •		1	262,19
	1044400068	400	250	260,00	7,475	• •		1	1.638,44
	1044400069	400	315	260,00	6,095	• •		1	1.454,97
	1044400070	400	355	260,00	5,520	• •		1	1.376,31
	1044450071	450	315	230,00	9,200	• •		1	2.162,75
	1044450072	450	355	230,00	7,590	• •		1	2.031,69
1044450073	450	400	230,00	7,590	• •		1	2.044,79	

**REDUCCIÓN, SOLDADURA A TOPE**

Sistemas: **aquatherm blue pipe**  
 Material: Fusiolen® PP-R  
 Normas: DIN 16962, UNE EN ISO 15874  
 Color: verde

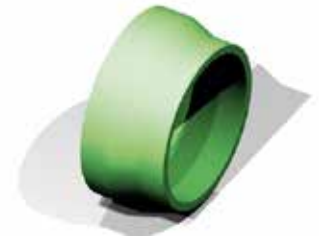
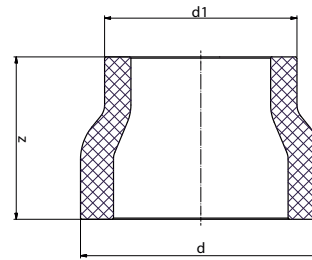

SDR	Art.-No.	Dimensión d [mm]	Dimensión d1 [mm]	z	Peso [kg]	Sistemas	Uds./Paquete	Uds./Caja	Precio € m/pc
ambas caras - Soldadura a tope									
17,6	2047200004	200	160	135,00	1,012	•	1	1	61,20
	2047250005	250	160	172,50	1,500	•	1	1	88,39
	2047250006	250	200	172,50	1,338	•	1	1	92,07
	2047315007	315	200	225,00	4,142	•	1	1	164,25
	2047315009	315	250	225,00	3,420	•	1	1	172,42
	2047355010	355	250	245,00	3,099	•	1	1	197,75
	2047355011	355	315	160,00	3,108	•	1	1	210,17
	2047400012	400	250	260,00	4,482	•	1	1	992,92
	2047400013	400	315	260,00	3,366	•	1	1	1.065,41
	2047400014	400	355	260,00	2,982	•	1	1	1.121,11
	2047450015	450	315	230,00	4,891	•	1	1	1.215,12
	2047450016	450	355	230,00	4,688	•	1	1	1.323,48
	2047450017	450	400	230,00	4,287	•	1	1	1.387,10
	2047500018	500	315	230,00	8,100	•	1	1	1.660,71
	2047500019	500	355	230,00	6,500	•	1	1	2.107,85
	2047500020	500	400	230,00	6,700	•	1	1	2.252,20
	2047500021	500	450	230,00	5,500	•	1	1	2.361,37
2047630022	630	400	230,00	15,100	•	1	1	3.646,17	
2047630023	630	450	200,00	13,700	•	1	1	3.964,06	
2047630024	630	500	200,00	11,000	•	1	1	4.034,05	

**CODO 90° SOLDADURA A ENCHUFE**

Sistemas: **aquatherm green pipe, aquatherm blue pipe**  
 Material: Fusiolen® PP-R  
 Normas: DIN 16962, UNE EN ISO 15874  
 Color: verde

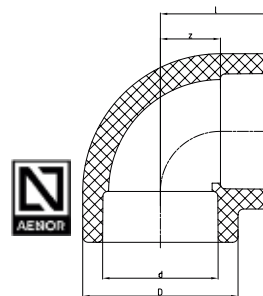

SDR	Art.-No.	Dimensión d [mm]	z	l	D	Peso [kg]	Sistemas	Uds./Paquete	Uds./Caja	Precio € m/pc
Soldadura a enchufe										
6 7,4 9 11 17,6	1080016040	16	9,00	22,00	24,50	0,010	•	10	2000	0,70
	1080020041	20	11,00	25,50	29,50	0,018	• • •	10	1400	0,76
	1080025042	25	13,50	29,50	34,00	0,023	• • •	10	800	1,02
	1080032043	32	17,00	35,00	43,00	0,043	• • •	5	400	1,46
	1080040044	40	21,00	41,50	52,00	0,071	• • •	5	250	2,61
	1080050045	50	26,00	49,50	68,00	0,163	• • •	5	125	5,93
	1080063046	63	32,50	60,00	84,00	0,290	• • •	1	70	9,74
	1080075047	75	38,50	68,50	100,00	0,446	• • •	1	40	18,53
	1080090048	90	46,00	79,00	120,00	0,743	• • •	1	25	32,94
	1080110049	110	56,00	93,00	147,00	1,282	• • •	1	15	47,16
	1080125050	125	76,50	116,50	167,00	2,006	• • •	1	10	72,49

**CODO 90° SOLDADURA A TOPE**

Sistemas: **aquatherm green pipe, aquatherm blue pipe**

Material: Fusiolen® PP-R & PP-RCT

Normas: DIN 16962, UNE EN ISO 15874

Nota Se está procediendo a la conversión gradual de los accesorios XXL contruidos a base de segmentos de tubería a accesorios de inyección en moldes. La tabla muestra los artículos de los que actualmente disponemos en el nuevo diseño en el momento de confección del catálogo.

Todos los accesorios que se han convertido a producción por inyección se encuentran aun disponibles, bajo pedido, en construcción a base de segmentos. No se ha asignado números de artículo a ninguno de estos elementos especiales.

**NOTA** Los manguitos de electrofusión no pueden utilizarse directamente con los accesorios de inyección. Cuando se usen manguitos de electrofusión se deberá soldar un trozo de tubo al accesorio de inyección o se deberá usar el accesorio construido a base de segmentos de tubería. Puede encontrar la colección completa de elementos aptos para electrosoldadura en el capítulo de electrofusión.

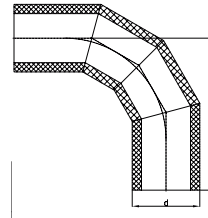

Accesorio de inyección

Accesorios a base de segmentos de tubería

SDR	Art.-No.	Dimensión d [mm]	z	Peso [kg]	Sistemas			Segmentos de tubería PP-RP	Inyección en molde* PP-R	Uds./Paquete	Uds./Caja	Precio € m/pc
<b>Soldadura a tope</b>												
9	1083160070	160	145,00	5,511	•	•			•	1		99,75
	1083200071	200	209,00	9,876	•	•			•	1		230,81
	1083250072	250	240,00	16,511	•	•			•	1		318,14
	1083315073	315	773,00	42,300	•			•		1		1.425,28
11	1084160052	160	145,00	1,922	•	•			•	1	8	81,10
	1084200054	200	209,00	8,140	•	•			•	1	12	205,86
	1084250056	250	240,00	18,000	•	•			•	1	6	274,48
	1084315057	315	773,00	37,850	•			•		1	2	1.098,84
1) estabilizada mediante una mezcla de fibra de vidrio integrada como una capa intermedia en el material fusiolen® PP-R.												
11	2084315028	315	773,00	37,300		•		•		1		1.119,86
	2084355032	355	833,00	57,064		•		•		1		1.469,82
	2084400036	400	900,00	74,500		•		•		1		1.571,63
	2084450040	450	975,00	89,080		•		•		1		2.557,87
17,6	2087160021	160	145,00	1,570		•			•	1		68,62
	2087200023	200	209,00	5,712		•			•	1		187,14
	2087250025	250	240,00	13,000		•			•	1		224,57
	2087315029	315	773,00	24,000		•		•		1		672,72
	2087355033	355	833,00	32,000		•		•		1		834,28
	2087400037	400	900,00	42,549		•		•		1		1.094,41
	2087450041	450	975,00	62,200		•		•		1		1.438,01
	2087500043	500	1100,00	91,000		•		•		1		1.947,04
2087630045	630	1295,00	164,600		•		•		1		4.161,31	

\* Estado en el momento de la elaboración del catálogo. Aumentará el número de accesorios

\*\* Para elementos de electrosoldadura ver página 43

**CODO 90° HEMBRA/MACHO**

Sistemas: **aquatherm green pipe, aquatherm blue pipe**  
 Material: Fusiolen® PP-R  
 Normas: DIN 16962, UNE EN ISO 15874  
 Color: verde

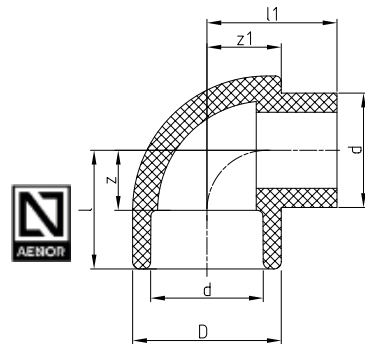

SDR	Art.-No.	Dimensión d [mm]	z	l	D	l1	z1	Peso [kg]	Sistemas	Uds./Paquete	Uds./Caja	Precio € m/pc
Soldadura a enchufe												
6 7,4 9 11	<b>1080016060</b>	<b>16</b>	9,00	22,00	24,50	21,75	12,00	0,010	• • •	10	2000	<b>0,70</b>
	<b>1080020061</b>	<b>20</b>	11,00	25,50	29,50	25,50	15,00	0,017	• • •	10	1200	<b>0,89</b>
	<b>1080025062</b>	<b>25</b>	13,50	29,50	34,00	29,50	17,00	0,023	• • •	10	800	<b>1,02</b>
	<b>1080032063</b>	<b>32</b>	17,00	35,00	43,00	39,00	21,50	0,047	• • •	5	400	<b>1,59</b>
	<b>1080040064</b>	<b>40</b>	21,00	41,50	52,00	45,50	26,00	0,080	• • •	5	300	<b>2,61</b>

**CODO 45° HEMBRA/MACHO**

Sistemas: **aquatherm green pipe, aquatherm blue pipe**  
 Material: Fusiolen® PP-R  
 Normas: DIN 16962, UNE EN ISO 15874  
 Color: verde

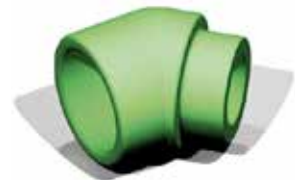
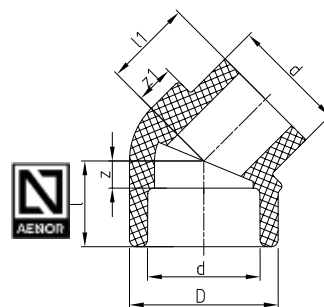

SDR	Art.-No.	Dimensión d [mm]	z	l	D	l1	z1	Peso [kg]	Sistemas	Uds./Paquete	Uds./Caja	Precio € m/pc
Soldadura a enchufe												
6 7,4 9 11	<b>1080020020</b>	<b>20</b>	5,00	19,50	29,50	19,50	9,00	0,013	• • •	10	1500	<b>0,76</b>
	<b>1080020021</b>	<b>25</b>	6,00	22,00	34,00	22,00	8,50	0,017	• • •	10	1000	<b>1,02</b>
	<b>1080032022</b>	<b>32</b>	7,50	25,50	43,00	28,50	11,50	0,036	• • •	5	500	<b>1,59</b>
	<b>1080040023</b>	<b>40</b>	9,50	30,00	52,00	30,50	13,50	0,057	• • •	5	300	<b>2,61</b>

**CODO 45° SOLDADURA A ENCHUFE**

Sistemas: **aquatherm green pipe, aquatherm blue pipe**  
 Material: Fusiolen® PP-R  
 Normas: DIN 16962, UNE EN ISO 15874  
 Color: verde

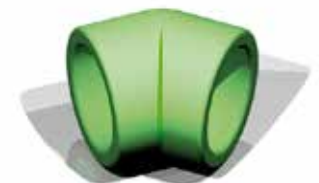
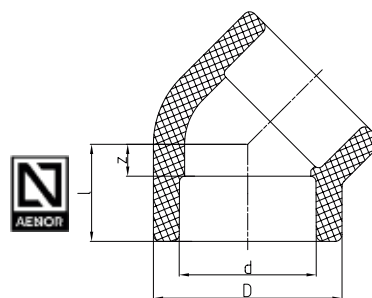

SDR	Art.-No.	Dimensión d [mm]	z	l	D	Peso [kg]	Sistemas	Uds./Paquete	Uds./Caja	Precio € m/pc
Soldadura a enchufe										
6 7,4 9 11 17,6	<b>1080016001</b>	<b>16</b>	4,50	17,50	24,50	0,009	• • •	10	2000	<b>0,70</b>
	<b>1080020002</b>	<b>20</b>	5,00	19,50	29,50	0,014	• • •	10	1500	<b>0,76</b>
	<b>1080025003</b>	<b>25</b>	6,00	22,00	34,00	0,018	• • •	10	1000	<b>0,96</b>
	<b>1080032004</b>	<b>32</b>	7,50	25,50	43,00	0,035	• • •	5	500	<b>1,51</b>
	<b>1080040005</b>	<b>40</b>	9,50	30,00	52,00	0,053	• • •	5	300	<b>2,62</b>
	<b>1080050006</b>	<b>50</b>	11,50	35,00	68,00	0,113	• • •	5	150	<b>5,93</b>
	<b>1080063007</b>	<b>63</b>	14,00	41,50	84,00	0,226	• • •	1	75	<b>9,74</b>
	<b>1080075008</b>	<b>75</b>	16,50	46,50	100,00	0,350	• • •	1	60	<b>18,59</b>
	<b>1080090009</b>	<b>90</b>	19,50	52,50	120,00	0,571	• • •	1	30	<b>31,75</b>
	<b>1080110010</b>	<b>110</b>	23,50	60,50	147,00	1,022	• • •	1	20	<b>47,04</b>
<b>1080125011</b>	<b>125</b>	27,00	67,00	167,00	1,309	• • •	1	15	<b>71,24</b>	

**CODO 45° SOLDADURA A TOPE**

Sistemas: **aquatherm green pipe, aquatherm blue pipe**  
 Material: Fusiolen® PP-R & PP-CT  
 Normas: DIN 16962, UNE EN ISO 15874  
 Nota

Se está procediendo a la conversión gradual de los accesorios XXL construidos a base de segmentos de tubería a accesorios de inyección en moldes.

**NOTA** Los manguitos de electrofusión no pueden utilizarse directamente con los accesorios de inyección. Cuando se usen manguitos de electrofusión se deberá soldar un trozo de tubo al accesorio de inyección o se deberá usar el accesorio construido a base de segmentos de tubería.

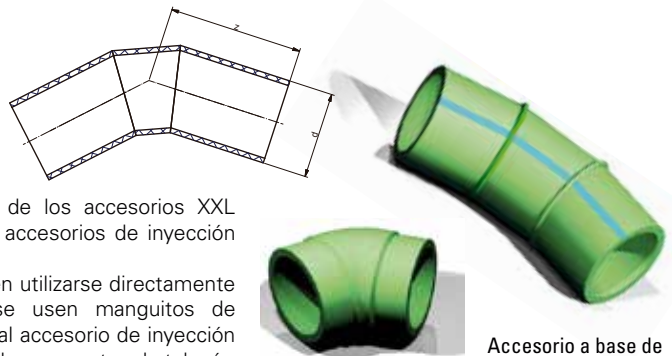

Accesorio de inyección      Accesorio a base de segmentos de tubería

SDR	Art.-No.	Dimensión [mm]	z	Peso [kg]	Sistemas			Segmentos de tubería PP-RP	Inyección en molde* PP-R	Uds./Paquete	Uds./Caja	Precio € m/pc
<b>Soldadura a tope</b>												
9	1083160030	160	250,00	3,564	•				•	1		115,34
	1083200031	200	274,00	6,120	•				•	1		365,80
	1083250032	250	412,00	14,380	•				•	1		631,79
	1083315033	315	517,00	27,608	•			•		1		1.078,51
11	1084160013	160	95,00	1,393	•	•			•	1	10	88,14
	1084200015	200	274,00	5,735	•	•			•	1	2	305,92
	1084250017	250	412,00	13,000	•	•			•	1	10	478,84
	1084315018	315	517,00	27,300	•			•		1	1	773,28
1) estabilizada mediante una mezcla de fibra de vidrio integrada como una capa intermedia en el material fusiolen® PP-R.												
11	2084315026	315	517,00	27,100		•		•		1		773,28
	2084355030	355	520,00	42,000		•		•		1		963,23
	2084400034	400	548,00	44,712		•		•		1		1.065,03
	2084450038	450	580,00	60,260		•		•		1		1.724,34
17,6	2087160020	160	249,00	1,730		•			•	1		81,41
	2087200022	200	274,00	3,672		•			•	1		279,52
	2087250024	250	412,00	9,400		•			•	1		367,96
	2087315027	315	498,00	18,000		•		•		1		576,53
	2087355031	355	520,00	22,058		•		•		1		691,93
	2087400035	400	548,00	30,800		•		•		1		834,28
	2087450039	450	580,00	39,123		•		•		1		1.098,90
	2087500042	500	665,00	55,112		•		•		1		1.476,18
2087630044	630	741,00	97,148		•		•		1		2.475,15	

**T - SOLDADURA A ENCHUFE**

Sistemas: **aquatherm green pipe, aquatherm blue pipe**  
 Material: Fusiolen® PP-R  
 Normas: DIN 16962, UNE EN ISO 15874  
 Color: verde

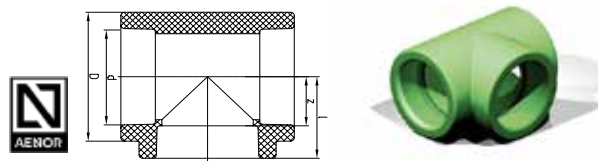

SDR	Art.-No.	Dimensión d [mm]	z	l	D	Peso [kg]	Sistemas			Uds./Paquete	Uds./Caja	Precio € m/pc
<b>Soldadura a enchufe</b>												
6 7,4 9 11 17,6	1060016015	16	9,00	22,00	24,50	0,015	•			10	1500	0,89
	1060020016	20	11,00	25,50	29,50	0,022	•	•	•	10	800	1,02
	1060025017	25	15,00	31,00	34,00	0,033	•	•	•	10	500	1,30
	1060032018	32	17,00	35,00	43,00	0,054	•	•	•	5	300	2,10
	1060040019	40	20,00	40,50	52,00	0,099	•	•	•	5	175	3,12
	1060050020	50	26,00	49,50	68,00	0,175	•	•	•	5	100	8,80
	1060063021	63	32,50	60,00	84,00	0,371	•	•	•	1	50	13,66
	1060075022	75	38,50	68,50	100,00	0,540	•	•	•	1	30	21,96
	1060090023	90	46,00	79,00	120,00	0,924	•	•	•	1	25	35,19
	1060110024	110	56,00	93,00	147,00	1,611	•	•	•	1	14	57,76
1060125025	125	76,50	116,50	167,00	2,655	•	•	•	1	8	91,01	

**T - SOLDADURA A TOPE**

Sistemas: **aquatherm green pipe, aquatherm blue pipe**  
 Material: Fusiolen® PP-R & PP-RCT  
 Normas: DIN 16962, UNE EN ISO 15874  
 Nota: Se está procediendo a la conversión gradual de los accesorios XXL construidos a base de segmentos de tubería a accesorios de inyección en moldes. La tabla muestra los artículos de los que actualmente disponemos en el nuevo diseño en el momento de confección del catálogo. Se informará de los cambios en aquatherm technews.

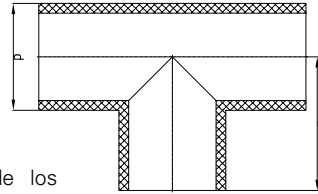

Todos los accesorios que se han convertido a producción por inyección se encuentran aun disponibles, bajo pedido, en construcción a base de segmentos. No se ha asignado números de artículo a ninguno de estos elementos especiales.

**NOTA** Los manguitos de electrofusión no pueden utilizarse directamente con los accesorios de inyección. Cuando se usen manguitos de electrofusión se deberá soldar un trozo de tubo al accesorio de inyección o se deberá usar el accesorio construido a base de segmentos de tubería.

Accesorio de inyección

Accesorios a base de segmentos de tubería

SDR	Art.-No.	Dimensión d [mm]	z	Peso [kg]	Sistemas			Segmentos de tubería PP-RP	Inyección en molde* PP-R	Uds./Paquete	Uds./Caja	Precio € m/pc
<b>Soldadura a tope</b>												
9	1063160019	160	230,00	5,512	•				•	1	5	128,94
	1063200020	200	250,00	9,367	•				•	1	2	380,52
	1063250021	250	375,00	21,949	•				•	1	8	673,71
	1063315022	315	460,00	42,609	•			•		1	1	1.382,86
11	1064160013	160	145,00	2,777	•	•			•	1	5	124,45
	1064200015	200	250,00	6,865	•	•			•	1	2	340,79
	1064250017	250	375,00	16,000	•	•			•	1	8	542,71
	1064315018	315	460,00	20,450	•			•		1	1	895,35
1) estabilizada mediante una mezcla de fibra de vidrio integrada como una capa intermedia en el material fusiolen® PP-R.												
11	2064315001	315	460,00	36,674		•			•	1	1	983,56
	2064355002	355	480,00	40,000		•			•	1		1.166,71
	2064400003	400	500,00	62,100		•			•	1		1.472,19
	2064450004	450	525,00	82,792		•			•	1		2.239,73
17,6	2067160010	160	145,00	2,716		•			•	1	5	85,64
	2067200011	200	250,00	4,660		•			•	1	2	286,95
	2067250012	250	375,00	11,500		•			•	1	8	405,48
	2067315013	315	460,00	19,800		•			•	1	1	712,26
	2067355014	355	480,00	27,500		•			•	1		868,28
	2067400015	400	500,00	40,395		•			•	1		1.071,77
	2067450016	450	525,00	45,400		•			•	1		1.404,13
	2067500017	500	600,00	75,726		•			•	1		1.906,11
2067630018	630	665,00	122,500		•			•	1		3.368,64	

\*Estado en el momento de la elaboración del catálogo. Aumentará el número de accesorios



**NUEVO** aquatherm blue pipe Y

Piezas especiales bajo demanda

**ATENCIÓN – A TENER EN CUENTA!**

Estas piezas son de uso en aplicaciones especiales, **sin presión**, por ejemplo, drenaje al vacío de aplicaciones navales. **NUNCA** se deben someter a las presiones indicadas en las tablas de presiones admisibles.

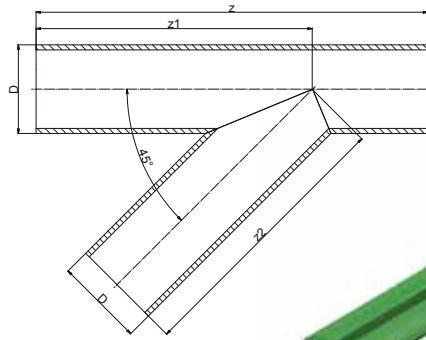

- Sistema:** aquatherm green pipe, aquatherm blue pipe
- Material:** Fusiolen® PP-RCT
- Normas:** DIN16962-2
- Color:** azul/verde

SDR	Art.-No.	Dimensión D [mm]	z	z1	z2	Peso [kg]	Sistema	Uds.	Uds./Caja	Precio € m/pc	
<i>Soldadura a enchufe</i>											
11	2084063001	63	560,00	380,00	380,00		• • •	1		136,30	
	2084075002	75	570,00	405,00	405,00		• • •	1		156,70	
	2084090003	90	577,00	412,00	412,00		• • •	1		178,53	
	2084110004	110	610,00	435,00	435,00		• • •	1		214,34	
	2084125005	125	665,00	475,00	475,00		• • •	1		259,01	
	<i>Soldadura a tope</i>										
	2013031	160	782,00	551,00	551,00		• • •	1		340,73	
2013035	200	925,00	650,00	650,00		• • •	1		466,86		
2013039	250	1105,00	780,00	780,00		• • •	1		702,10		
<i>Soldadura a enchufe</i>											
17.6	2087125006	125	665,00	475,00	475,00		• • •	1		235,92	
	<i>Soldadura a tope</i>										
	2087160008	160	782,00	551,00	551,00		• • •	1		295,12	
	2087200010	200	925,00	650,00	650,00		• • •	1		388,63	
2087250012	250	1105,00	780,00	780,00		• • •	1		545,27		

**CRUZ**

- Sistemas:** aquatherm green pipe, aquatherm blue pipe
- Material:** Fusiolen® PP-R
- Normas:** DIN 16962, UNE EN ISO 15874
- Color:** verde

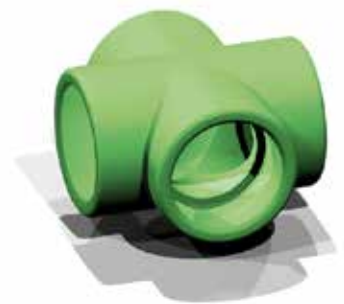
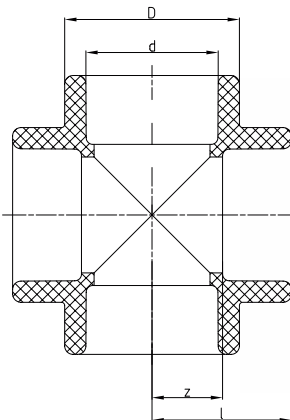

SDR	Art.-No.	Dimensión d [mm]	z	l	D	Peso [kg]	Sistemas	Uds./ Paquete	Uds./Caja	Precio € m/pc
<i>Soldadura a enchufe</i>										
6 7,4 9 11	1040020090	20	26,00	11,50	29,50	0,025	• • •	10	500	2,62
	1040025091	25	29,50	13,50	34,00	0,035	• • •	10	500	2,81
	1040032092	32	35,00	17,00	43,00	0,064	• • •	5	250	3,87
	1040040093	40	41,50	21,00	52,00	0,099	• • •	5	150	8,36

**T REDUCIDA - SOLDADURA A ENCHUFE**

Sistemas: **aquatherm green pipe, aquatherm blue pipe**  
 Material: Fusiolen® PP-R  
 Normas: DIN 16962, UNE EN ISO 15874  
 Color: verde

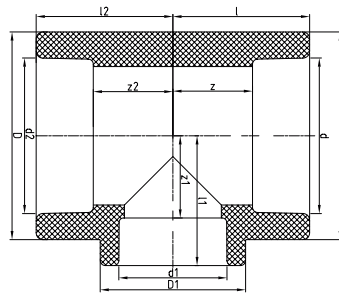

SDR	Art.-No.	d	d1	d2	l	l1	l2	z	z1	z2	D	D1	Peso [kg]	Sistemas	Uds./ Paqu	Uds./ Caja	Precio € m/pc	
Soldadura a enchufe																		
6 7,4 9 11 17,6	1060020030	20	16	16	25,50	25,50	25,50	11,00	12,00	12,50	29,50	29,50	0,025	•	10	1000	1,18	
	1060020031	20	16	20	25,50	25,50	25,50	11,00	12,00	11,00	29,50	29,50	0,024	•	10	1000	1,18	
	1060020032	20	20	16	25,50	25,50	25,50	11,00	11,00	12,50	29,50	29,50	0,023	•	10	1000	1,18	
	1060020033	20	25	20	31,00	30,50	31,00	16,50	14,50	16,50	34,00	34,00	0,040	• • •	10	500	1,50	
	1060025034	25	16	16	31,00	30,50	31,00	15,00	17,50	18,00	34,00	34,00	0,043	•	10	500	1,50	
	1060025035	25	16	20	31,00	30,50	31,00	15,00	17,50	16,50	34,00	34,00	0,041	•	10	500	1,50	
	1060025036	25	16	25	31,00	30,50	31,00	15,00	17,50	15,00	34,00	34,00	0,038	•	10	500	1,50	
	1060025037	25	20	20	31,00	30,50	31,00	15,00	16,00	16,50	34,00	34,00	0,039	• • •	10	500	1,50	
	1060025038	25	20	25	31,00	30,50	31,00	15,00	16,00	15,00	34,00	34,00	0,036	• • •	10	500	1,50	
	1060032039	32	16	32	35,00	31,00	35,00	17,00	18,00	17,00	43,00	29,50	0,053	• • •	5	300	2,31	
	1060032040	32	20	20	36,50	37,00	36,50	18,75	22,50	22,25	43,00	43,00	0,075	• • •	5	300	2,31	
	1060032041	32	20	32	35,00	31,00	35,00	17,00	16,50	17,00	43,00	29,50	0,049	• • •	5	300	2,31	
	1060032042	32	25	25	35,00	34,50	35,00	17,00	18,50	15,00	43,00	43,00	0,069	• • •	5	300	2,31	
	1060032043	32	25	32	35,00	34,50	35,00	17,00	18,50	17,00	43,00	43,00	0,050	• • •	5	300	2,31	
	1060040044	40	20	40	41,50	36,00	41,50	21,00	21,50	21,00	52,00	34,00	0,091	• • •	5	200	3,49	
	1060040045	40	25	40	41,50	36,00	41,50	21,00	20,00	21,00	52,00	34,00	0,090	• • •	5	200	3,49	
	1060040046	40	32	40	42,00	40,50	42,00	21,50	22,50	21,50	52,00	52,00	0,092	• • •	5	200	3,49	
	1060050047	50	20	50	49,50	40,50	49,50	26,00	26,00	26,00	68,00	29,50	0,161	• • •	5	100	9,48	
	1060050048	50	25	50	49,50	44,50	49,50	26,00	28,50	26,00	68,00	43,00	0,158	• • •	5	100	9,48	
	1060050049	50	32	50	49,50	44,50	49,50	26,00	26,50	26,00	68,00	43,00	0,159	• • •	5	100	9,48	
	1060050050	50	40	50	49,50	49,50	49,50	26,00	29,00	26,00	68,00	68,00	0,161	• • •	5	100	9,48	
	1060063051	63	20	63	60,00	48,50	60,00	32,50	34,00	32,50	84,00	34,00	0,334	• • •	1	50	12,16	
	1060063052	63	25	63	60,00	48,50	60,00	32,50	32,50	32,50	84,00	34,00	0,329	• • •	1	50	12,16	
	1060063053	63	32	63	60,00	53,50	60,00	32,50	35,50	32,50	84,00	52,00	0,342	• • •	1	50	12,16	
	1060063054	63	40	63	60,00	53,50	60,00	32,50	33,00	32,50	84,00	52,00	0,333	• • •	1	50	12,16	
	1060063055	63	50	63	60,00	60,00	60,00	32,50	36,50	32,50	84,00	84,00	0,402	• • •	1	50	12,16	
	1060075056	75	20	75	68,50	54,50	68,50	38,50	40,00	38,50	100,00	34,00	0,501	• • •	1	35	20,96	
	1060075057	75	25	75	68,50	54,50	68,50	38,50	38,50	38,50	100,00	34,00	0,497	• • •	1	35	20,96	
	1060075058	75	32	75	68,50	59,00	68,50	38,50	41,00	38,50	100,00	52,00	0,506	• • •	1	35	20,96	
	1060075059	75	40	75	68,50	59,00	68,50	38,50	38,50	38,50	100,00	52,00	0,496	• • •	1	35	20,96	
	1060075060	75	50	75	68,50	66,00	68,50	38,50	42,50	38,50	100,00	84,00	0,553	• • •	1	35	20,96	
	1060075061	75	63	75	68,50	66,00	68,50	38,50	38,50	38,50	100,00	84,00	0,518	• • •	1	35	20,96	
	1060090062	90	32	90	79,00	65,00	79,00	46,00	47,00	46,00	120,00	52,00	0,882	• • •	1	25	36,74	
1060090063	90	40	90	79,00	65,00	79,00	46,00	44,50	46,00	120,00	52,00	0,870	• • •	1	25	36,74		
1060090064	90	50	90	79,00	75,00	79,00	46,00	51,50	46,00	120,00	84,00	0,908	• • •	1	25	36,74		
1060090065	90	63	90	79,00	75,00	79,00	46,00	47,50	46,00	120,00	84,00	0,874	• • •	1	25	36,74		
1060090066	90	75	90	79,00	81,00	79,00	46,00	51,00	46,00	120,00	120,00	0,993	• • •	1	25	36,74		
1060110067	110	63	110	93,00	87,50	93,00	56,00	60,00	56,00	147,00	100,00	1,567	• • •	1	15	57,64		
1060110068	110	75	110	93,00	87,50	93,00	56,00	57,50	56,00	147,00	100,00	1,501	• • •	1	15	57,64		
1060110069	110	90	110	93,00	89,00	93,00	56,00	56,00	56,00	147,00	120,00	1,534	• • •	1	15	57,64		
1060125070	125	75	125	116,50	106,50	116,50	76,50	76,50	76,50	167,00	100,00	2,421	• • •	1	8	75,67		
1060125071	125	90	125	116,50	109,50	116,50	76,50	76,50	76,50	167,00	120,00	2,519	• • •	1	8	75,67		
1060125072	125	110	125	116,50	113,50	116,50	76,50	76,50	76,50	167,00	147,00	2,563	• • •	1	8	75,67		

**T REDUCIDA - SOLDADURA A TOPE**

Sistemas: **aquatherm green pipe, aquatherm blue pipe**  
 Material: Fusiolen® PP-R & PP-RCT  
 Normas: DIN 16962, UNE EN ISO 15874  
 Derivación: Soldadura a enchufe

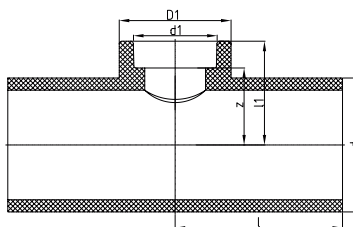

Accesorio a base de segmentos de tubería

Nota: Se está procediendo a la conversión gradual de los accesorios XXL construidos a base de segmentos de tubería a accesorios de inyección en moldes. La tabla muestra los artículos de los que actualmente disponemos en el nuevo diseño en el momento de confección del catálogo. Se informará de los cambios en aquatherm technews.

Todos los accesorios que se han convertido a producción por inyección se encuentran aun disponibles, bajo pedido, en construcción a base de segmentos. No se ha asignado números de artículo a ninguno de estos elementos especiales.



Accesorio de inyección

**NOTA** Los manguitos de electrofusión no pueden utilizarse directamente con los accesorios de inyección. Cuando se usen manguitos de electrofusión se deberá soldar un trozo de tubo al accesorio de inyección o se deberá usar el accesorio construido a base de segmentos de tubería.

SDR	Art.-No.	d	d1	l	l1	z	D	Peso [kg]	Sistemas	Segmento de tubería PP-RP	Inyección en molde* PP-R	Uds./Paquete	Uds./Caja	Precio € m/pc
Derivación: Soldadura a enchufe														
9	1063160120	160	75	230,00	122,00	92,00	100,00	3,903	•	•		1	4	255,57
	1063160121	160	90	230,00	125,00	92,00	120,00	4,039	•	•		1	4	268,67
	1063200122	200	75	250,00	142,00	112,00	100,00	6,476	•	•		1	6	318,14
	1063200123	200	90	250,00	145,00	112,00	120,00	6,581	•	•		1	1	327,87
	1063200124	200	110	250,00	149,00	112,00	147,00	6,863	•	•		1	1	338,17
	1063200125	200	125	250,00	155,00	115,00	167,00	7,114	•	•		1	1	366,99
	1063250127	250	75	375,00	167,00	137,00	100,00	14,802	•	•		1	1	530,86
	1063250128	250	90	375,00	170,00	137,00	120,00	14,932	•	•		1	10	563,61
	1063250129	250	110	375,00	174,00	137,00	147,00	15,178		•		1	10	570,16
	1063250130	250	125	375,00	180,00	140,00	167,00	15,398	•	•		1	10	589,81
1063315133	315	125	460,00	212,50	172,50	167,00	29,196	•	•		1	10	819,25	
11	1064160074	160	75	230,00	122,00	92,00	100,00	3,140	•	•		1	4	237,73
	1064160076	160	90	230,00	125,00	92,00	120,00	3,176	•	•		1	4	244,16
	1064160078	160	125	145,00	130,00	115,00	167,00	2,842	•	•	•	1	6	255,76
	1064200080	200	75	250,00	142,00	112,00	100,00	5,284	•	•		1	1	288,39
	1064200082	200	90	250,00	145,00	112,00	120,00	5,168	•	•		1	1	294,94
	1064200084	200	110	250,00	149,00	112,00	147,00	5,648	•	•		1	1	318,14
	1064200086	200	125	250,00	155,00	115,00	167,00	5,786	•	•		1	1	325,82
	1064250090	250	75	375,00	167,00	137,00	100,00	12,000	•	•		1	10	413,27
	1064250092	250	90	375,00	170,00	137,00	120,00	12,000	•	•		1	10	448,96
	1064250094	250	110	375,00	174,00	137,00	147,00	13,000	•	•		1	10	440,97
	1064250096	250	125	375,00	180,00	140,00	167,00	12,000	•	•		1	10	461,50
	1064315101	315	125	460,00	213,00	173,00	167,00	25,150	•	•		1	1	569,79

**T REDUCIDA - SOLDADURA A TOPE**

Sistemas: **aquatherm green pipe**  
 Material: Fusiolen® PP-R & PP-RCT  
 Normas: DIN 16962, UNE EN ISO 15874  
 Derivación: Soldadura a tope

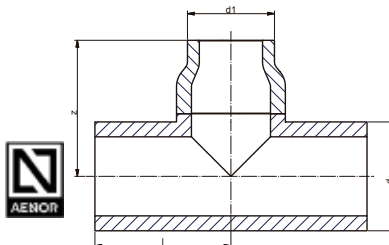

SDR	Art.-No.	d	d1	l	z	Peso [kg]	Sistemas	Uds./Paquete	Uds./Caja	Precio € m/pc
Derivación: Soldadura a tope										
9	1063200126	200	160	250,00	300,00	9,332	•	1	1	498,11
	1063250131	250	160	375,00	375,00	21,547	•	1	1	917,56
	1063250132	250	200	375,00	376,00	21,853	•	1	1	943,76
	1063315134	315	160	460,00	238,00	29,273	•	1	1	871,65
	1063315135	315	200	460,00	460,00	42,166	•	1	1	1.821,96
	1063315136	315	250	460,00	460,00	42,557	•	1	1	2.051,27
11	1064200088	200	160	250,00	300,00	7,445	• •	1		458,75
	1064250098	250	160	375,00	375,00	19,500	• •	1	4	668,47
	1064250100	250	200	375,00	375,00	18,500	• •	1	4	648,82
	1064315102	315	160	460,00	237,50	24,850	•	1	1	773,34
	1064315103	315	200	460,00	460,00	29,400	•	1		1.140,39
	1064315104	315	250	460,00	460,00	30,250	•	1	4	1.120,67

**aquatherm blue pipe T REDUCIDA - SOLDADURA A TOPE**

Sistemas: **aquatherm blue pipe**  
 Material: Fusiolen® PP-RCT  
 Normas: DIN 16962, UNE EN ISO 15874  
 Color: Azul/Verde  
 Derivación: Soldadura a enchufe

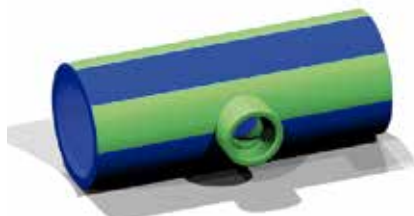
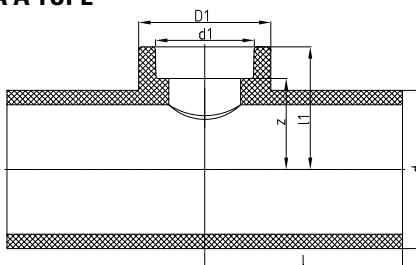

SDR	Art.-No.	d	d1	l	l1	z	D	Peso [kg]	Sistemas	Uds./Paquete	Uds./Caja	Precio € m/pc
Derivación: Soldadura a enchufe												
11	2064160018	160	75	230,00	122,00	92,00	100,00	3,140	•	1		132,31
	2064160019	160	90	230,00	125,00	92,00	120,00	3,176	•	1		137,67
	2064200020	200	75	250,00	142,00	112,00	100,00	5,460	•	1		170,36
	2064200021	200	90	250,00	145,00	112,00	120,00	5,580	•	1		176,97
	2064200022	200	110	250,00	149,00	112,00	147,00	5,810	•	1		183,52
	2064200023	200	125	250,00	155,00	115,00	167,00	6,100	•	1		207,10
	2064250025	250	75	375,00	167,00	137,00	100,00	12,440	•	1		308,04
	2064250026	250	90	375,00	170,00	137,00	120,00	12,420	•	1		311,97
	2064250027	250	110	375,00	174,00	137,00	147,00	12,760	•	1		315,84
	2064250028	250	125	375,00	180,00	140,00	167,00	13,030	•	1		337,54
	2064315031	315	125	460,00	213,00	173,00	167,00	25,000	•	1		584,39
	2064355035	355	125	480,00	233,00	193,00	167,00	32,500	•	1		701,29
	2064400040	400	125	500,00	255,00	215,00	167,00	42,100	•	1		996,16
	2064450046	450	125	525,00	280,00	240,00	167,00	55,700	•	1		1.368,02

**aquatherm blue pipe T REDUCIDA - SOLDADURA A TOPE**

Sistemas: **aquatherm blue pipe**  
 Material: Fusiolen® PP-RCT  
 Normas: DIN 16962, UNE EN ISO 15874  
 Color: Azul/Verde  
 Derivación: Soldadura a tope

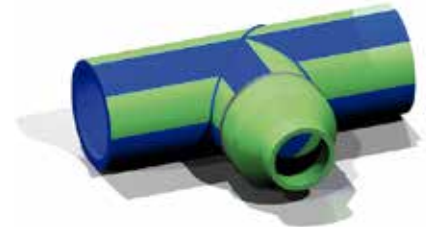
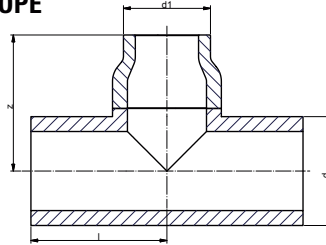

SDR	Art.-No.	d	d1	l	z	Peso [kg]	Sistemas	Uds./Paquete	Uds./Caja	Precio € m/pc
Derivación: Soldadura a tope										
11	2064315032	315	160	460,00	238,00	25,000	•	1		629,17
	2064315033	315	200	460,00	460,00	33,200	•	1		1.140,39
	2064315034	315	250	460,00	460,00	34,200	•	1		1.422,29
	2064355036	355	160	480,00	258,00	32,500	•	1		720,94
	2064355037	355	200	480,00	268,00	30,200	•	1		799,60
	2064355038	355	250	480,00	480,00	40,000	•	1		1.336,95
	2064355039	355	315	480,00	480,00	40,000	•	1		1.402,51
	2064400041	400	160	500,00	354,00	44,100	•	1		1.101,03
	2064400042	400	200	500,00	318,00	44,100	•	1		1.154,05
	2064400043	400	250	500,00	280,00	46,000	•	1		1.278,81
	2064400044	400	315	500,00	500,00	56,000	•	1		1.571,63
	2064400045	400	355	500,00	500,00	54,300	•	1		3.149,62
	2064450047	450	160	525,00	379,00	57,900	•	1		1.488,91
	2064450048	450	200	525,00	343,00	57,900	•	1		1.490,91
	2064450049	450	250	525,00	305,00	57,900	•	1		1.494,65
2064450050	450	315	525,00	315,00	58,400	•	1		1.540,12	
2064450051	450	355	525,00	525,00	75,000	•	1		4.155,08	
2064450052	450	400	525,00	525,00	76,000	•	1		4.351,64	

**aquatherm blue pipe T REDUCIDA - SOLDADURA A TOPE**

Sistemas: **aquatherm blue pipe**  
 Material: Fusiolen® PP-RCT  
 Normas: DIN 16962, UNE EN ISO 15874  
 Color: Azul  
 Derivación: Soldadura a enchufe

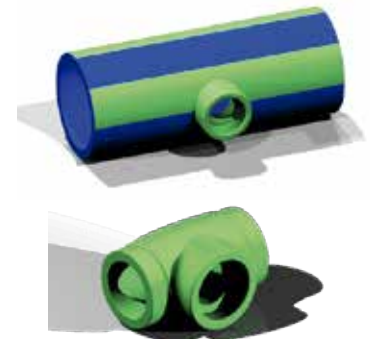
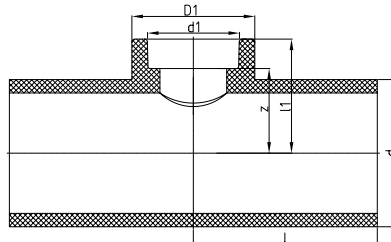

SDR	Art.-No.	d	d1	l	l1	z	D	Peso [kg]	Sistemas	Uds./Paquete	Uds./Caja	Precio € m/pc
Derivación: Soldadura a enchufe												
17,6	2067160060	160	75	230,00	122,00	92,00	100,00	2,227	•	1		111,41
	2067160061	160	90	230,00	125,00	92,00	120,00	2,364	•	1		115,97
	2067160062	160	125	145,00	130,00	115,00	167,00	2,309	•	1		124,08
	2067200063	200	75	250,00	142,00	112,00	100,00	3,620	•	1		144,16
	2067200064	200	90	250,00	145,00	112,00	120,00	3,742	•	1		150,77
	2067200065	200	110	250,00	149,00	112,00	147,00	3,976	•	1		157,26
	2067200066	200	125	250,00	155,00	115,00	167,00	4,269	•	1		183,46
	2067250068	250	75	375,00	167,00	137,00	100,00	8,149	•	1		229,37
	2067250069	250	90	375,00	170,00	137,00	120,00	8,274	•	1		235,92
	2067250070	250	110	375,00	174,00	137,00	147,00	8,504	•	1		238,54
	2067250071	250	125	375,00	180,00	140,00	167,00	9,000	•	1		262,19
	2067315074	315	125	460,00	213,00	173,00	167,00	17,570	•	1		412,90
	2067355078	355	125	480,00	233,00	193,00	167,00	21,500	•	1		504,60
	2067400083	400	125	500,00	255,00	215,00	167,00	27,690	•	1		675,02
	2067450089	450	125	525,00	280,00	240,00	167,00	36,470	•	1		865,09
	2067500096	500	125	600,00	305,00	265,00	167,00	51,250	•	1		1.186,24
2067630104	630	125	665,00	370,00	330,00	167,00	89,170	•	1		2.169,30	

**aquatherm blue pipe T REDUCIDA - SOLDADURA A TOPE**

Sistemas: **aquatherm blue pipe**  
 Material: Fusiolen® PP-RCT  
 Normas: DIN 16962, UNE EN ISO 15874  
 Color: Azul  
 Derivación: Soldadura a tope

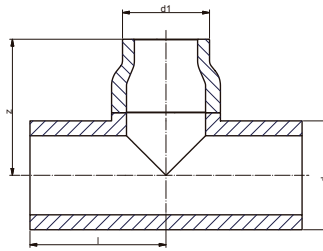

SDR	Art.-No.	d	d1	l	z	Peso [kg]	Sistemas	Uds./ Paquete	Uds./Caja	Precio € m/pc
Soldadura a tope										
17,6	2067200067	200	160	250,00	250,00	5,000	•	1		445,65
	2067250072	250	160	375,00	375,00	11,600	•	1		557,06
	2067250073	250	200	375,00	375,00	11,500	•	1		563,61
	2067315075	315	160	460,00	238,00	16,500	•	1		458,75
	2067315076	315	200	460,00	460,00	23,600	•	1		943,76
	2067315077	315	250	460,00	460,00	22,600	•	1		950,31
	2067355079	355	160	480,00	258,00	21,500	•	1		543,96
	2067355080	355	200	480,00	268,00	21,900	•	1		766,79
	2067355081	355	250	480,00	480,00	28,300	•	1		1.101,03
	2067355082	355	315	480,00	480,00	30,500	•	1		1.146,94
	2067400084	400	160	500,00	354,00	29,700	•	1		786,44
	2067400085	400	200	500,00	318,00	29,700	•	1		792,24
	2067400086	400	250	500,00	280,00	29,000	•	1		798,48
	2067400087	400	315	500,00	500,00	35,800	•	1		1.094,48
	2067400088	400	355	500,00	500,00	39,700	•	1		2.306,91
	2067450090	450	160	525,00	379,00	37,000	•	1		983,06
	2067450091	450	200	525,00	343,00	37,000	•	1		1.006,42
	2067450092	450	250	525,00	305,00	37,000	•	1		995,60
	2067450093	450	315	525,00	315,00	37,000	•	1		1.042,07
	2067450094	450	355	525,00	525,00	50,500	•	1		3.407,94
	2067450095	450	400	525,00	525,00	50,100	•	1		3.355,54
	2067500097	500	160	600,00	404,00	53,400	•	1		1.297,59
	2067500098	500	200	600,00	368,00	53,500	•	1		1.304,20
	2067500099	500	250	600,00h	330,00	53,500	•	1		1.343,50
2067500100	500	315	600,00	340,00	54,000	•	1		1.356,60	
2067500101	500	355	600,00	600,00	72,500	•	1		4.194,44	
2067500102	500	400	600,00	600,00	72,700	•	1		4.043,66	
2067500103	500	450	600,00	600,00	71,500	•	1		3.886,40	
2067630105	630	160	665,00	474,00	91,530	•	1		2.306,91	
2067630106	630	200	665,00	438,00	91,500	•	1		2.313,46	
2067630107	630	250	665,00	400,00	91,500	•	1		2.320,01	
2067630108	630	315	665,00	405,00	92,350	•	1		2.372,41	
2067630109	630	400	665,00	665,00	133,800	•	1		7.163,27	
2067630110	630	450	665,00	665,00	133,400	•	1		6.973,20	
2067630111	630	500	665,00	665,00	130,700	•	1		6.580,01	

**TAPÓN**

Sistemas: **aquatherm green pipe,**  
**aquatherm blue pipe**  
Material: Fusiolen® PP-R  
Normas: DIN 16962, UNE EN ISO 15874  
Color: verde

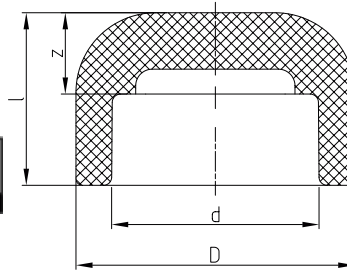

SDR	Art.-No.	Dimensión d [mm]	l	z	D	Peso [kg]	Sistemas	Uds./ Paquete	Uds./Caja	Precio € m/pc
Soldadura a enchufe										
6 7,4 9 11	1020016001	16	26,50	13,50	26	0,008	•	10	2000	1,12
	1020020002	20	24,00	9,50	29,5	0,009	• • •	10	2000	1,25
	1020025003	25	24,00	8,00	34	0,011	• • •	10	1500	1,75
	1020032004	32	31,50	13,50	43	0,019	• • •	5	1000	2,18
	1020040005	40	38,00	17,50	52	0,043	• • •	5	500	3,12
	1020050006	50	44,50	21,00	68	0,081	• • •	5	300	4,80
	1020063007	63	52,00	24,50	84	0,144	• • •	1	150	8,05
	1020075008	75	58,50	28,50	100	0,243	• • •	1	90	11,17
	1020090009	90	57,50	34,50	120	0,368	• • •	1	60	25,64
	1020110010	110	65,00	28,00	147	0,635	• • •	1	40	31,88
1020125011	125	70,00	30,00	167	0,862	• • •	1	30	43,98	

Soldadura a tope



9	1023160022	160	70,00	17,90	124,20	0,60	•	1		59,26
	1023200023	200	80,00	22,40	155,20	1,10	•	1		78,48
	1023250024	250	90,00	34,20	194,20	2,00	•	1		117,97
	1023315025	315	65,00	52,50	244,60	5,80	•	1		956,86
11	1024160013	160	70,00	14,60	130,80	0,818	• •	1	30	58,33
	1024200015	200	80,00	18,20	163,30	1,070	• •	1	24	72,61
	1024250017	250	90,00	22,70	204,60	1,989	• •	1	10	90,45
	1024315018	315	270,00	28,70	257,80	6,200	• •	1	5	530,86
	1024355019	355	65,00	67,50	290,60	9,500	• •	1	2	773,34
	1024400020	400	60,00	70,00	327,40	8,500	• •	1		1.199,34
1024450021	450	70,00	70,00	368,20	12,200	• •	1		1.631,88	
17,6	2027160001	160	70,00	14,60	141,80	0,679	•	1		39,99
	2027200002	200	80,00	11,40	177,20	0,925	•	1		58,95
	2027250003	250	90,00	14,20	221,60	2,109	•	1		76,42
	2027315004	315	50,00	40,00	279,20	2,961	•	1		518,89
	2027355005	355	52,00	42,00	314,80	3,930	•	1		727,42
	2027400006	400	60,00	50,00	354,60	5,821	•	1		1.052,49
	2027450007	450	70,00	56,00	399,00	8,520	•	1		1.400,77
	2027500008	500	75,00	62,00	443,20	12,500	•	1		1.912,35
2027630009	630	90,00	78,00	558,60	23,500	•	1		3.250,67	

**DERIVACIÓN EN ASIENTO**

Sistemas: **aquatherm green pipe,**  
**aquatherm blue pipe**  
Material: Fusiolen® PP-R  
Normas: DIN 16962, UNE EN ISO 15874  
Color: verde

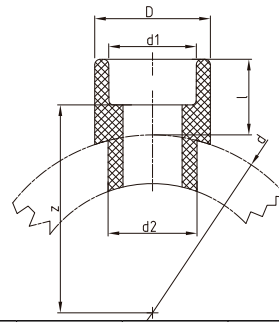

**NOTA:** \*no usar con aquatherm blue pipe OT

SDR	Art.-No.	d	d1	d2	l	z	D	Peso [kg]	Sistemas	Uds./Paquete	Uds./Caja	Precio € m/pc
Soldadura a enchufe												
6 7,4 9 11 17,6	1030040001*	40	20	25,00	27,00	32,50	29,50	0,016	• • •	5	1000	3,05
	1030040002*	40	25	25,00	28,50	32,50	34,00	0,017	• • •	5	1000	3,05
	1030050003	50	20	25,00	27,50	38,00	29,50	0,018	• • •	5	1000	2,93
	1030050004	50	25	25,00	28,50	37,50	34,00	0,019	• • •	5	1000	2,93
	1030063005	63	20	25,00	27,50	44,50	29,50	0,017	• • •	5	1000	2,93
	1030063006	63	25	25,00	28,50	44,00	34,00	0,019	• • •	5	750	2,93
	1030063007	63	32	32,00	30,00	43,50	43,00	0,028	• • •	5	750	2,93
	1030075008	75	20	25,00	27,50	50,50	29,50	0,018	• • •	5	1000	2,93
	1030075009	75	25	25,00	28,50	50,00	34,00	0,019	• • •	5	750	2,93
	1030075010	75	32	32,00	30,00	49,50	43,00	0,028	• • •	5	750	2,93
	1030075011	75	40	40,00	34,00	51,00	52,00	0,049	• • •	5	400	2,93
	1030090012	90	20	25,00	27,50	58,00	29,50	0,018	• • •	5	1000	2,93
	1030090013	90	25	25,00	28,50	57,50	34,00	0,019	• • •	5	1000	2,93
	1030090014	90	32	32,00	30,00	57,00	43,00	0,029	• • •	5	750	2,93
	1030090015	90	40	40,00	34,00	58,50	52,00	0,048	• • •	5	500	2,93
	1030110016	110	20	25,00	27,50	68,00	29,50	0,019	• • •	5	1000	2,93
	1030110017	110	25	25,00	28,50	68,50	34,00	0,020	• • •	5	1000	2,93
	1030110018	110	32	32,00	30,00	67,00	43,00	0,030	• • •	5	750	2,93
	1030110019	110	40	40,00	34,00	68,50	52,00	0,050	• • •	5	450	2,93
	1030110020	110	50	50,00	34,00	65,50	68,00	0,091	• • •	5	200	4,52
	1030125021	125	20	25,00	27,50	75,50	67,00	0,019	• • •	5	1000	2,93
	1030125022	125	25	25,00	28,50	75,00	34,00	0,020	• • •	5	1000	2,93
	1030125023	125	32	32,00	30,00	74,50	43,00	0,029	• • •	5	750	2,93
	1030125024	125	40	40,00	34,00	76,00	52,00	0,050	• • •	5	450	2,93
	1030125025	125	50	50,00	34,00	73,00	68,00	0,091	• • •	5	200	4,52
	1030125026	125	63	63,00	38,00	73,00	84,00	0,150	• • •	5	125	6,17
	1030160027	160	20	25,00	27,50	93,00	29,50	0,021	• • •	5	700	6,74
	1030160028	160	25	25,00	28,50	92,50	34,00	0,023	• • •	5	700	6,74
	1030160029	160	32	32,00	30,00	92,00	43,00	0,034	• • •	5	500	7,11
	1030160030	160	40	40,00	34,00	93,50	52,00	0,054	• • •	5	300	10,85
	1030160031	160	50	50,00	34,00	90,50	84,00	0,093	• • •	5	200	10,54
	1030160032	160	63	63,00	38,00	90,50	84,00	0,155	• • •	5	120	8,80
1030250035	200-250	20	25,00	27,50	113,00	29,50	0,020	• • •	5	100	3,99	
1030250036	200-250	25	25,00	28,50	112,50	34,00	0,021	• • •	5	100	3,99	
1030250037	200-250	32	32,00	30,00	112,00	43,00	0,031	• • •	5	50	3,99	
1030200038	200	40	40,00	34,00	113,50	52,00	0,049	• • •	5	200	7,98	
1030200039	200	50	50,00	34,00	110,50	68,00	0,087	• • •	5	200	11,73	
1030200040	200	63	63,00	37,50	110,00	84,00	0,147	• • •	5	120	11,98	
1030250045	250	40	40,00	34,00	138,50	52,00	0,053	• • •	5	150	12,23	
1030250046	250	50	50,00	34,00	135,50	68,00	0,090	• • •	5	100	9,79	
1030250047	250	63	63,00	37,50	135,00	84,00	0,152	• • •	5	140	11,91	
1030315052	315-355	63	63,00	37,50	167,50	84,00	0,153	• • •	1	120	38,74	



**NUEVO aquatherm DERIVACIÓN EN ASIENTO - CARGA**

Para la ampliación de sistemas en funcionamiento  
Usar en combinación con la herramienta de la página 70

Sistemas: **aquatherm green pipe,**  
**aquatherm blue pipe**

Material: Fusiolen® PP-R

Norma: DIN 16962, UNE EN ISO 15874

Color: verde

Nota: No utilizar con aquatherm blue pipe OT

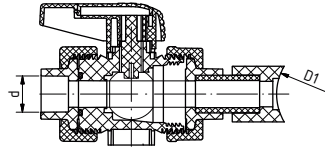

SDR	Art.-No.	d	D1	l	z2	D	Peso [kg]	Sistemas	Uds./Paquete	Uds./Caja	Precio € m/pc
<i>Soldadura a enchufe</i>											
6 7,4 9 11 17,6	1090075010	40	75	34,00	20,5	52,00	0,040	• • •	5		258,94
	1090090011	40	90	34,00	20,5	52,00	0,040	• • •	5		259,82
	1090110012	40	110	34,00	20,5	52,00	0,039	• • •	5		234,75
	1090125013	40	125	34,00	20,5	52,00	0,038	• • •	5		259,23
	1090125014	63	125	38,00	27,5	84,00	0,119	• • •	5		361,81
	1090160015	40	160	34,00	20,5	52,00	0,038	• • •	5		259,53
	1090160016	63	160	38,00	27,5	84,00	0,993	• • •	5		360,16
	1090200017	40	200	34,00	20,5	52,00	0,036	• • •	5		235,14
	1090200018	63	200	37,50	27,5	84,00	0,108	• • •	5		329,33
	1090250019	40	250	34,00	20,5	52,00	0,036	• • •	5		260,71
	1090250020	63	250	37,50	27,5	84,00	0,108	• • •	5		361,75
	1090315021	63	315-355	37,50	27,5	84,00	0,106	• • •	5		370,76
1090400022	63	400-630	37,50	27,5	84,00	0,103	• • •	5		411,50	

**DERIVACIÓN EN ASIENTO CON ROSCA MACHO**

Sistemas: **aquatherm green pipe, aquatherm blue pipe**

Material: Fusiolen® PP-R

Normas: DIN 16962, UNE EN ISO 15874

Color: verde

**NOTA** \*no usar con aquatherm blue pipe OT

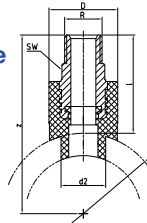

SDR	Art.-No.	d	d2	l	z	D	R	SW	Peso [kg]	Sistemas	Uds./Paquete	Uds./Caja	Precio € m/pc
<i>Soldadura a enchufe</i>													
6 7,4 9 11 17,6	1030040102*	40	25	55,00	75,00	38,50	1/2"	21,00	0,088	• • •	5	300	11,67
	1030050108	50	25	55,00	80,00	38,50	1/2"	21,00	0,090	• • •	5	300	11,67
	1030063114	63	25	55,00	86,50	38,50	1/2"	21,00	0,089	• • •	5	300	11,67
	1030075121	75	25	55,00	92,50	38,50	1/2"	21,00	0,097	• • •	5	300	11,67
	1030090129	90	25	55,00	100,00	38,50	1/2"	21,00	0,090	• • •	5	300	11,67
	1030110137	110	25	55,00	110,00	38,50	1/2"	21,00	0,089	• • •	5	300	11,67
	1030125145	125	25	55,00	117,50	38,50	1/2"	21,00	0,092	• • •	5	300	14,91
	1030160153	160	25	55,00	135,00	38,50	1/2"	21,00	0,092	• • •	5	250	15,16
	1030040103	40	25	56,00	76,00	43,50	3/4"	24,00	0,107	• • •	5	250	17,03
	1030050109	50	25	56,00	81,00	43,50	3/4"	24,00	0,110	• • •	5	250	17,40
	1030063115	63	25	56,00	87,50	43,50	3/4"	24,00	0,109	• • •	5	250	20,52
	1030075122	75	25	56,00	93,50	43,50	3/4"	24,00	0,109	• • •	5	250	20,52
	1030090130	90	25	56,00	101,00	43,50	3/4"	24,00	0,110	• • •	5	250	20,52
	1030110138	110	25	56,00	111,00	43,50	3/4"	24,00	0,110	• • •	5	250	20,52
	1030125146	125	25	56,00	118,50	43,50	3/4"	24,00	0,112	• • •	5	250	20,52
	1030160154	160	25	56,00	136,00	43,50	3/4"	24,00	0,112	• • •	5	250	20,52

Con rosca macho y cabeza hexagonal, soldar con matriz para soldadura en asiento para calentar la pared interna del tubo y la superficie.  
Las herramientas necesarias para la soldadura de las derivaciones en asiento se enumeran a partir de la página 64.

**DERIVACIÓN EN ASIENTO CON ROSCA HEMBRA**

Sistemas: **aquatherm green pipe, aquatherm blue pipe**  
 Material: Fusiolen® PP-R  
 Normas: DIN 16962, UNE EN ISO 15874  
 Color: verde  
**NOTA** \*no usar con aquatherm blue pipe OT

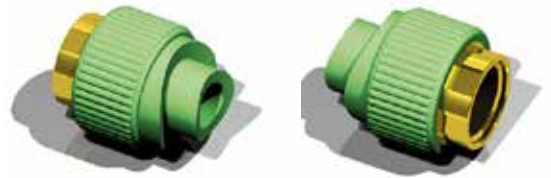
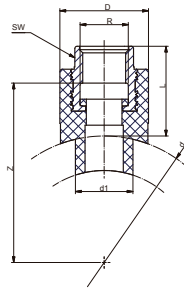

SDR	Art.-No.	d	d1	l	z	D	R	SW	Peso [kg]	Sistemas	Uds./Paquete	Uds./Caja	Precio € m/pc	
<b>Latón</b>														
6 7,4 9 11 17,6	1030040100*	40	25	39,00	43,00	38,50	1/2"	24,00	0,088	• • •	5	300	11,17	
	1030050106	50	25	39,00	48,00	38,50	1/2"	24,00	0,090	• • •	5	300	11,17	
	1030063112	63	25	39,00	54,50	38,50	1/2"	24,00	0,089	• • •	5	300	11,17	
	1030075118	75	25	39,00	53,50	38,50	1/2"	24,00	0,083	• • •	5	300	11,17	
	1030090126	90	25	39,00	68,00	38,50	1/2"	24,00	0,090	• • •	5	300	11,17	
	1030110134	110	25	39,00	78,00	38,50	1/2"	24,00	0,089	• • •	5	300	11,17	
	1030125142	125	25	39,00	85,50	38,50	1/2"	24,00	0,092	• • •	5	250	11,17	
	1030160150	160	25	39,00	103,00	38,50	1/2"	24,00	0,092	• • •	5	250	11,17	
	1030250158	200	25	39,00	38,00	38,50	1/2"	24,00	0,092	• • •	5	50	11,17	
	1030040101	40	25	39,00	43,00	43,50	3/4"	31,00	0,107	• • •	5	300	13,66	
	1030050107	50	25	39,00	49,50	43,50	3/4"	31,00	0,110	• • •	5	300	13,66	
	1030063113	63	25	39,00	55,50	43,50	3/4"	31,00	0,109	• • •	5	300	13,66	
	1030075119	75	25	39,00	63,00	43,50	3/4"	31,00	0,109	• • •	5	300	13,66	
	1030090127	90	25	39,00	73,00	43,50	3/4"	31,00	0,110	• • •	5	300	13,66	
	1030110135	110	25	39,00	80,50	43,50	3/4"	31,00	0,110	• • •	5	300	13,66	
	1030125143	125	25	39,00	96,00	43,50	3/4"	31,00	0,112	• • •	5	300	13,66	
	1030160151	160	25	39,00	58,50	43,50	3/4"	31,00	0,112	• • •	5	250	13,66	
	1030250159	200	25	39,00	66,00	43,50	3/4"	31,00	0,112	• • •	5	250	13,66	
	1030075120	75	32	43,00	76,00	60,00	1"	39,00	0,222	• • •	5	125	18,83	
	1030090128	90	32	43,00	83,50	60,00	1"	39,00	0,221	• • •	5	125	18,83	
	1030110136	110	32	43,00	101,00	60,00	1"	39,00	0,224	• • •	5	125	18,83	
	1030125144	125	32	43,00	123,00	60,00	1"	39,00	0,222	• • •	5	125	18,83	
	1030160152	160	32	43,00	118,00	60,00	1"	39,00	0,226	• • •	5	125	18,83	
	1030250160	200	32	43,00	121,00	60,00	1"	39,00	0,244	• • •	5	25	28,07	
	<b>NUEVO Acero inoxidable</b>													
	1030040104*	40	25	39,00	15,50	38,50	1/2"	24	0,088	• • •	5	300	28,57	
	1030050110	50	25	39,00	15,50	38,50	1/2"	24	0,090	• • •	5		28,57	
	1030063116	63	25	39,00	15,50	38,50	1/2"	24	0,067	• • •	5	300	29,32	
	1030075123	75	25	39,00	15,50	38,50	1/2"	24	0,067	• • •	5	300	29,32	
	1030090131	90	25	39,00	15,50	38,50	1/2"	24	0,069	• • •	5	300	29,32	
	1030110139	110	25	39,00	15,50	38,50	1/2"	24	0,089	• • •	5		29,32	
	1030125147	125	25	39,00	15,50	38,50	1/2"	24	0,069	• • •	5	250	29,32	
1030160155	160	25	39,00	15,50	38,50	1/2"	24	0,071	• • •	5	250	29,32		
1030250161	200-250	25	39,00	15,50	38,50	1/2"	24	0,000	• • •	5		32,07		
1030040105	40	25	39,00	20,50	43,50	3/4"	31	0,080	• • •	5	300	36,12		
1030050111	50	25	39,00	20,50	43,50	3/4"	31	0,083	• • •	5	300	36,12		
1030063117	63	25	39,00	20,50	43,50	3/4"	31	0,109	• • •	5		37,18		
1030075124	75	25	39,00	20,50	43,50	3/4"	31	0,109	• • •	5	300	37,18		
1030090132	90	25	39,00	20,50	43,50	3/4"	31	0,084	• • •	5	300	37,18		
1030110140	110	25	39,00	20,50	43,50	3/4"	31	0,082	• • •	5	300	37,18		
1030125148	125	25	39,00	20,50	43,50	3/4"	31	0,084	• • •	5	300	37,18		
1030160156	160	25	39,00	20,50	43,50	3/4"	31	0,085	• • •	5	250	37,18		
1030250162	200-250	25	39,00	20,50	43,50	3/4"	31	0,083	• • •	5	250	38,55		
1030075125	75	32	43,00	22,00	60,00	1"	39	0,217	• • •	5		62,69		
1030090133	90	32	43,00	22,00	60,00	1"	39	0,088	• • •	5		62,69		
1030110141	110	32	43,00	22,00	60,00	1"	39	0,088	• • •	5		62,69		
1030125149	125	32	43,00	22,00	60,00	1"	39	0,056	• • •	5		62,69		
1030160157	160	32	43,00	22,00	60,00	1"	39	0,057	• • •	5		62,69		
1030250163	200-250	32	43,00	22,00	60,00	1"	39	0,057	• • •	5		62,69		

**PORTABRIDAS - SOLDADURA A ENCHUFE**

con junta plana

Sistemas: **aquatherm green pipe, aquatherm blue pipe**

Material: Fusiolen® PP-R

Normas: DIN 16962, UNE EN ISO 15874

Color: verde

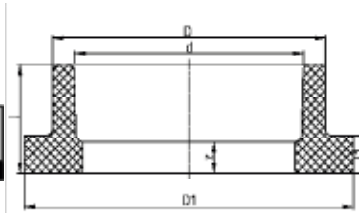

SDR	Art.-No.	Dimensión d [mm]	l	z	D	D1	l1	z1	Peso [kg]	Sistemas	Uds./Paquete	Uds./Caja	Precio € m/pc
Soldadura a enchufe													
6 7,4 9 11	<b>1050032020</b>	<b>32</b>	35,00	17,00	41,00	68,00	11,00	3,00	0,053	• • •	1	500	<b>5,74</b>
	<b>1050040021</b>	<b>40</b>	36,50	16,00	50,00	78,00	12,00	3,00	0,071	• • •	1	250	<b>7,55</b>
	<b>1050050022</b>	<b>50</b>	40,50	17,00	61,00	88,00	13,00	3,00	0,095	• • •	1	200	<b>11,04</b>
	<b>1050063023</b>	<b>63</b>	44,50	16,00	76,00	102,00	15,00	3,00	0,130	• • •	1	100	<b>13,54</b>
	<b>1050075024</b>	<b>75</b>	47,00	17,00	90,00	122,00	17,00	3,00	0,191	• • •	1	80	<b>17,28</b>
	<b>1050090025</b>	<b>90</b>	50,00	17,00	108,00	138,00	17,00	3,00	0,258	• • •	1	50	<b>22,02</b>
	<b>1050110026</b>	<b>110</b>	55,50	18,50	131,00	158,00	18,50	3,00	0,329	• • •	1	40	<b>34,56</b>
	<b>1050125027*</b>	<b>125</b>	202,00	202,00	125,00	158,00	13,50	3,00	1,330	• • •	1	16	<b>86,40</b>
<b>1050125028</b>	<b>125</b>	63,00	23,00	165,00	188,00	20,00	3,00	0,724	• • •	1	25	<b>39,36</b>	

\*sólo aplicable como accesorio, hasta portabridas de 110mm

**PORTABRIDAS - SOLDADURA A TOPE**

con junta plana

Sistemas: **aquatherm green pipe, aquatherm blue pipe**

Material: Fusiolen® PP-R

Normas: DIN 16962, UNE EN ISO 15874

Color: verde

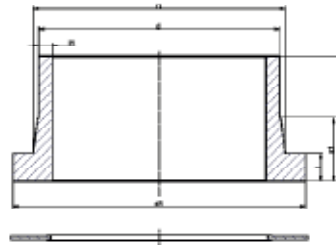

SDR	Art.-No.	Dimensión d [mm]	l	z	D	D1	l1	z1	Peso [kg]	Sistemas	Uds./Paquete	Uds./Caja	Precio € m/pc
Soldadura a tope													
9	<b>1023160000</b>	<b>160</b>	25,00	93,00	175,00	212	17,90	53,00	0,98	• • •	1	16	<b>78,66</b>
	<b>1023200031</b>	<b>200</b>	32,00	130,00	232,00	268	22,40	72,00	2,00	• • •	1	5	<b>222,83</b>
	<b>1023250032</b>	<b>250</b>	35,00	130,00	285,00	320	27,90	75,00	3,10	• • •	1	6	<b>281,84</b>
	<b>1023315033</b>	<b>315</b>	35,00	170,00	337,00	370	35,20	90,00	5,50	• • •	1	3	<b>1.618,79</b>
11	<b>1054160030</b>	<b>160</b>	25,00	93,00	175,00	212	14,60	6,00	0,955	• • •	1	16	<b>61,57</b>
	<b>1054200032</b>	<b>200</b>	32,00	130,00	232,00	268	18,20	6,00	1,957	• • •	1	5	<b>203,17</b>
	<b>1054250034</b>	<b>250</b>	35,00	130,00	285,00	320	22,70	6,00	2,717	• • •	1	6	<b>249,02</b>
	<b>1054315035</b>	<b>315</b>	35,00	170,00	333,00	370	28,60	6,00	5,650	• • •	1	3	<b>629,17</b>
	<b>1054355036</b>	<b>355</b>	42,00	185,00	370,00	432	32,20	6,00	9,000	• • •	1	1	<b>904,40</b>
	<b>1054400037</b>	<b>400</b>	33,00	199,00	425,00	484	22,70	6,00	12,000	• • •	1	1	<b>989,62</b>
<b>1054450038</b>	<b>450</b>	46,00	140,00	425,00	586	25,70	7,00	16,500	• • •	1	1	<b>1.278,00</b>	
17,6	<b>2057160100</b>	<b>160</b>	25,00	93,00	175,00	212	9,10	3,00	0,821	• • •	1	11	<b>52,34</b>
	<b>2057200101</b>	<b>200</b>	32,00	130,00	232,00	268	11,40	6,00	1,849	• • •	1	11	<b>146,78</b>
	<b>2057250102</b>	<b>250</b>	35,00	130,00	285,00	320	14,20	6,00	2,736	• • •	1	11	<b>197,62</b>
	<b>2057315103</b>	<b>315</b>	35,00	170,00	333,00	370	17,90	6,00	4,500	• • •	1	11	<b>655,31</b>
	<b>2057355104</b>	<b>355</b>	42,00	185,00	370,00	432	20,10	6,00	6,500	• • •	1	11	<b>806,15</b>
	<b>2057400105</b>	<b>400</b>	33,00	199,00	425,00	484	22,70	6,00	8,500	• • •	1	11	<b>891,30</b>
	<b>2057450106</b>	<b>450</b>	46,00	140,00	512,00	586	25,70	7,00	12,000	• • •	1	11	<b>904,40</b>
	<b>2057500107</b>	<b>500</b>	47,00	141,00	525,00	585	28,40	7,00	9,800	• • •	1	11	<b>1.133,77</b>
<b>2057630108</b>	<b>630</b>	50,00	142,00	640,00	688	35,70	7,00	12,600	• • •	1	11	<b>1.487,72</b>	

## ELEMENTOS DE TRANSICIÓN

### PORTABRIDAS - SOLDADURA A TOPE para instalación de válvulas de mariposa

Sistemas: **aquatherm green pipe, aquatherm blue pipe**  
 Material: Fusiolen® PP-R  
 Normas: DIN 16962, UNE EN ISO 15874  
 Color: verde

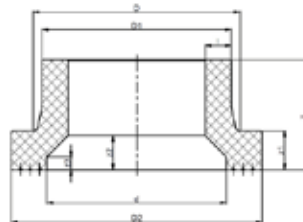

SDR	Art.-No.	Dimensión d [mm]	l	z	D	D1	l1	z1	Peso [kg]	Sistemas	Uds./Paquete	Uds./Caja	Precio € m/pc
Soldadura a tope													
11	1024315032	315	35,00	170,00	333,00	370	28,60	6,00	5,650	• •	1	1	884,75
	1024355034	355	42,00	185,00	370,00	432	32,20	6,00	9,000	• •	1	1	1.258,29
	1024400036	400	33,00	199,00	425,00	484	22,70	6,00	12,000	• •	1	1	1.474,62
	1024450038	450	46,00	140,00	425,00	586	25,70	7,00	16,000	• •	1	1	2.130,00
17,6	2027315903	315	35,00	170,00	333,00	370	17,90	6,00	4,500	•	1	11	722,50
	2027355904	355	42,00	185,00	370,00	432	20,10	6,00	6,500	•	1	11	1.083,75
	2027400905	400	33,00	199,00	425,00	484	22,70	6,00	8,500	•	1	11	1.336,20
	2027450906	450	46,00	140,00	512,00	586	25,70	7,00	12,000	•	1	11	1.397,21
	2027500907	500	47,00	141,00	525,00	585	28,40	7,00	9,800	•	1	11	1.560,84
	2027630908	630	50,00	142,00	640,00	688	35,70	7,00	12,600	•	1	11	1.683,54

### BRIDA DE ACERO CON REVESTIMIENTO PLÁSTICO

Sistemas: **aquatherm green pipe, aquatherm blue pipe**  
 Material: PP/Acero  
 Color: negro  
 Norma: DIN2633

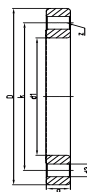

SDR	Art.-No.	Dimensión	DN	fits to Art.-No.	d1	D	K	d2	b	z	Peso [kg]	Sistemas	Uds./Paquete	Uds./Caja	Precio € m/pc
Soldadura a enchufe															
6 7,4 9 11 17,6	1040032130	32	1"	15512	42	116,00	85,00	14	15,50	4,00	0,466	• • •	1	100	22,77
	1040040131	40	1 1/4"	15514	51	141,00	100,00	18	17,50	4,00	0,681	• • •	1	80	32,75
	1040050132	50	1 1/2"	15516	62	151,00	110,00	18	17,50	4,00	0,767	• • •	1	60	35,62
	1040063133	63	2"	15518	78	166,00	125,00	18	19,00	4,00	0,885	• • •	1	40	42,29
	1040075134	75	2 1/2"	15520	92	186,00	145,00	18	19,00	4,00	1,154	• • •	1	40	48,16
	1040090135	90	3"	15522	110	201,00	160,00	18	21,00	8,00	1,404	• • •	1	30	59,82
	1040110136	110	4"	15524/26	133	221,00	180,00	18	22,00	8,00	1,461	• • •	1	20	81,28
	1040125137	125	5"	15527	167	251,00	210,00	18	26,00	8,00	2,096	• • •	1	15	114,03
	1040160138	160	6"	15530 15531 2515530	178	286,00	240,00	22	27,00	8,00	3,628	• •	1	16	146,84
	1040200139	200	8"	15534 15535 2515534	235	341,00	295,00	22	28,00	8,00	4,643	• •	1	4	216,65
	1040200139*	200	8"	15534 15535 2515534	235	341,00	295,00	22	28,00	12,00	4,643	• •	1	4	186,59
	1040250140	250	10"	15538 15539 2515538	288	406,00	350,00	22	31,00	12,00	7,216	• •	1	4	267,93
	1040250140*	250	10"	15538 15539 2515538	288	406,00	350,00	22	31,00	12,00	7,216	• •	1	4	283,65
	1040315141	315	12"	15543 2515542	340	460,00	400,00	22	34,50	12,00	9,500	• •	1	1	356,32
	1040355142	355	14"	15545 2515544	380	520,00	460,00	22	39,00	16,00	15,300	• •	1	1	570,22
	1040400143	400	16"	2515546	430	565,00	515,00	26	34,00	16,00	50,558	• •	1	1	596,42
1040450144	450	20"	2515548	517	670,00	620,00	26	42,00	20,00	65,789	• •	1	1	819,25	
1040500145	500	20"	2515550	533	670,00	620,00	26	38,00	20,00	60,783	• •	1	1	812,64	
1040630146	630	24"	2515554	645	785,00	725,00	30	40,00	20,00	82,112	• •	1	1	1.356,60	

\* Bridas compatibles PN16

**TORNILLOS DE CABEZA HEXAGONAL**Sistemas: **aquatherm green pipe, aquatherm blue pipe**

Material: Acero

Color: galvanizado

Art.-No.	Dimensión	Para acoplar en brida de diámetro	Peso [kg]	Uds / paquete	€/ Ud
15604	M16x120 mm	110-125			3,31
15608	M20 X 180 mm	315-355			8,30
15610	M16 X 100 mm	40-90			2,74
15612	M12 X 80 mm	32			1,43
15614	M20 X 150 mm	160-250			6,86
15616	M16 X 60 mm	90 (para válvula 41602)			2,06

**ACOPLAMIENTO DE PP-R DESMONTABLE**Sistemas: **aquatherm green pipe, aquatherm blue pipe**

Material: Fusiolen® PP-R

Normas: DIN 16962, UNE EN ISO 15874

Color: verde

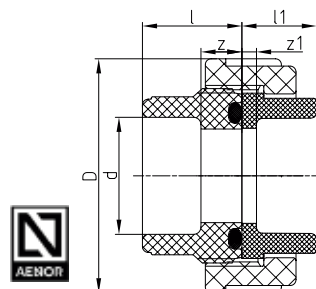

SDR	Art.-No.	Dimensión d [mm]	l	z	l1	z1	D	Peso [kg]	Sistemas	Uds./ Paquete	Uds./Caja	Precio € m/pc
Soldadura a enchufe												
6 7,4 9 11	1050020050	20	26,00	12,00	20,00	5,50	46,00	0,036	• • •	10	300	31,62
	1050025051	25	28,00	12,00	21,00	5,00	56,00	0,058	• • •	10	250	34,68
	1050032052	32	32,00	12,00	23,00	5,00	66,00	0,089	• • •	5	200	38,55
	1050040053	40	38,00	14,00	25,50	5,00	79,00	0,136	• • •	5	150	71,99
	1050050054	50	45,00	16,00	28,50	5,00	87,00	0,170	• • •	5	100	95,75
	1050063055	63	55,50	20,00	32,50	5,00	107,00	0,240	• • •	1	60	113,10
	1050075056	75	50,00	20,00	36,00	6,00	128,00	0,451	• • •	1	40	156,14

**ACOPLAMIENTO DESMONTABLE DE LATÓN**Sistemas: **aquatherm green pipe, aquatherm blue pipe**

Material: Fusiolen® PP-R, latón

Normas: DIN 16962, UNE EN ISO 15874

Color: verde, latón

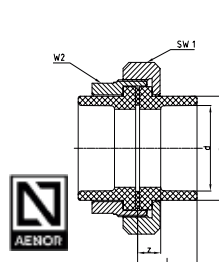

SDR	Art.-No.	Dimensión d [mm]	l	z	D	SW1	SW2	Peso [kg]	Sistemas	Uds./ Paquete	Uds./Caja	Precio € m/pc
Soldadura a enchufe												
6 7,4 9 11	1050032040	32	36,50	18,50	41,00	64,00	50,00	0,479	• • •	1	100	77,17
	1050040041	40	38,00	17,50	50,00	80,00	60,00	0,841	• • •	1	50	130,44
	1050050042	50	41,00	17,50	61,00	86,00	70,00	0,821	• • •	1	50	133,37
	1050063043	63	45,00	17,50	76,00	108,00	90,00	1,498	• • •	1	25	218,33
	1050075044	75	47,50	17,50	90,00	128,00	104,00	1,998	• • •	1	15	265,87

**MANGUITO ELECTROSOLDABLE (ELECTROFUSIÓN)**

Sistemas: **aquatherm green pipe,**  
**aquatherm blue pipe**

Material: Fusiolen® PP-R

Normas: DIN 16962, UNE EN ISO 15874

Color: verde

Nota: para su uso con accesorios de 160 mm, estos deben de solicitarse con cuello largo

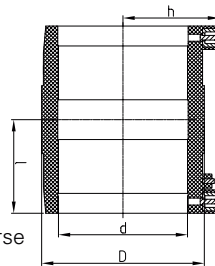

SDR	Art.-No.	Dimensión d [mm]	l	l1	D	Peso [kg]	Sistemas	Uds./ Paquete	Uds./Caja	Precio € m/pc
Electro-Soldadura a enchufe										
6 7,4 9 11 17,6	1040020094	20	35,00	36,00	31,50	0,049	• • •	1	500	26,51
	1040025100	25	39,00	38,50	36,50	0,057	• • •	1	350	27,88
	1040032101	32	40,00	42,50	45,00	0,077	• • •	1	300	31,62
	1040040102	40	46,00	47,00	54,00	0,103	• • •	1	200	32,01
	1040050103	50	51,50	52,00	65,00	0,142	• • •	1	130	34,43
	1040063104	63	59,00	58,00	81,50	0,239	• • •	1	75	49,78
	1040075105	75	65,00	64,50	96,00	0,347	• • •	1	45	59,57
	1040090106	90	72,50	72,00	113,50	0,501	• • •	1	30	75,98
	1040110107	110	80,00	82,50	139,00	0,821	• • •	1	22	108,61
	1040125108	125	86,00	90,00	156,00	1,097	• • •	1	16	146,35
	1040160109*	160	93,00	109,50	197,00	1,754	• •	1	10	190,07
	1040200110*	200	105,00	134,00	243,00	3,625	• •	1	2	360,50
	1040250111*	250	125,00	170,00	315,00	7,142	• •	1	2	458,75

\*no usar con aquatherm blue pipe OT pipe

**REDUCCIONES PARA ELECTROFUSIÓN**

Sistemas: **aquatherm green pipe, aquatherm blue pipe**

Material: Fusiolen® PP-R & PP-RCT

Color: verde/azul

Nota: Pueden solicitarse más medidas si así se requiere

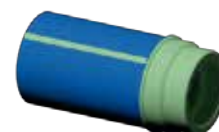

SDR	Art.-No.	Dimensión d [mm]	Dimensión d1 [mm]	l	z	D	Peso [kg]	Sistemas	Uds./Paquete	Uds./Caja	Precio € m/pc
un lado soldadura a enchufe, el otro lado soldadura a tope											
9	1043160122L	160	110	127,00	50,00	147,00	0,669	•	1		192,82
	1043160123L	160	125	130,00	50,00	167,00	0,754	•	1		205,05
	1043200124L	200	125	275,00	95,00	167,00	1,453	•	1		256,26
11	1044160053L	160	110	130,00	53,00	147,00	0,595	•	1		168,18
	1044160055L	160	125	130,00	50,00	167,00	0,705	•	1		181,53
	1044200057L	200	125	275,00	95,00	167,00	1,358	•	1		220,89
	2044160053L	160	110	140,00	53,00	147,00	0,595	• •	1		168,18
	2044160055L	160	125	140,00	50,00	167,00	0,705	• •	1		181,53
	2044200057L	200	125	275,00	95,00	167,00	1,358	• •	1		220,89
17,6	2047160001L	160	110	130,00	53,00	147,00		•	1		166,31
	2047160002L	160	125	130,00	50,00	167,00	0,628	•	1		179,53
	2047200003L	200	125	275,00	95,00	167,00	1,055	•	1		219,21

## CODO 45° PARA ELECTROFUSIÓN

Sistemas: **aquatherm green pipe, aquatherm blue pipe**  
 Material: Fusiolen® PP-R & PP-RCT  
 Normas: DIN 16962, UNE EN ISO 15874  
 Nota: Pueden solicitarse más medidas si así se requiere



SDR	Art.-No.	Dimensión d [mm]	z	Peso [kg]	Sistemas	Segmentos de tubería	Inyección en molde*	Uds./Paquete	Uds./Caja	Precio € m/pc
9	1083160030L	160	285,00	5,511	•			•	1	328,56
	1083200031L	200	215,00	9,876	•			•	1	593,87
	1083250032L	250	360,00	16,511	•			•	1	904,40
11	1084160013L	160	285,00	1,922	•			•	1	250,96
	1084200015L	200	215,00	8,140	•			•	1	517,01
	1084250017L	250	360,00	18,000	•			•	1	792,86
	2084160013L	160	285,00	1,922		•		•	1	250,96
	2084200015L	200	215,00	8,140		•		•	1	517,01
	2084250017L	250	360,00	18,000		•		•	1	792,86
17,6	2087160020	160	285,00	1,570		•		•	1	218,89
	2087200022	200	215,00	5,712		•		•	1	447,96
	2087250024	250	360,00	13,000		•		•	1	629,17

## CODO 90° PARA ELECTROFUSIÓN



SDR	Art.-No.	Dimensión d [mm]	z	Peso [kg]	Sistemas	Segmentos de tubería	Inyección en molde*	Uds./Paquete	Uds./Caja	Precio € m/pc
9	1083160070L	160	285,00	5,511	•			•	1	287,01
	1083200071L	200	215,00	9,876	•			•	1	460,81
	1083250072L	250	360,00	16,511	•			•	1	597,80
11	1084160052L	160	285,00	1,922	•			•	1	253,58
	1084200054L	200	215,00	8,140	•			•	1	416,08
	1084250056L	250	360,00	18,000	•			•	1	584,95
	2084160052L	160	285,00	1,922		•		•	1	253,58
	2084200054L	200	215,00	8,140		•		•	1	416,08
	2084250056L	250	360,00	18,000		•		•	1	584,95
17,6	2087160021L	160	285,00	1,570		•		•	1	218,71
	2087200023L	200	215,00	5,712		•		•	1	359,81
	2087250025L	250	360,00	13,000		•		•	1	484,51

## TE PARA ELECTROFUSIÓN



SDR	Art.-No.	Dimensión d [mm]	z	Peso [kg]	Sistemas	Segmentos de tubería	Inyección en molde*	Uds./Paquete	Uds./Caja	Precio € m/pc
9	1063160019L	160	285,00	5,511	•			•	1	443,59
	1063200020L	200	215,00	9,876	•			•	1	807,71
	1063250021L	250	360,00	16,511	•			•	1	1.191,79
11	1064160013L	160	285,00	1,922	•			•	1	385,45
	1064200015L	200	215,00	8,140	•			•	1	729,73
	1064250017L	250	360,00	18,000	•			•	1	1.063,28
	2064160013L	160	285,00	1,922		•		•	1	385,45
	2064200015L	200	215,00	8,140		•		•	1	729,73
	2064250017L	250	360,00	18,000		•		•	1	1.063,28
17,6	2067160010L	160	285,00	1,570		•		•	1	319,45
	2067200011L	200	215,00	5,712		•		•	1	452,20
	2067250012L	250	360,00	13,000		•		•	1	847,46

## TAPÓN PARA ELECTROFUSIÓN

Sistemas: **aqualtherm green pipe,**  
**aqualtherm blue pipe**

Material: Fusiolen® PP-R & PP-RCT

Normas: DIN 16962, UNE EN ISO 15874

Color: verde

Nota: Pueden solicitarse más medidas si así se requiere



SDR	Art.-No.	Dimensión d [mm]	l	z	D	Peso [kg]	Sistemas			Uds./ Paquete	Uds./Caja	Precio € m/pc
9	1023160022L	160	210,00			0,60	•			1		157,39
	1023200023L	200	220,00			1,10	•			1		223,95
	1023250024L	250	230,00			2,00	•			1		450,89
11	1024160013L	160	210,00			0,818	•			1		132,12
	1024200015L	200	220,00			1,070	•			1		183,09
	1024250017L	250	230,00			1,989	•			1		264,50
	2024160013L	160	210,00			0,818		•		1		132,12
	2024200015L	200	220,00			1,070		•		1		183,09
	2024250017L	250	230,00			1,989		•		1		264,50
17,6	2027160001L	160	210,00			0,679			•	1		144,22
	2027200002L	200	220,00			0,925			•	1		203,05
	2027250003L	250	230,00			2,109			•	1		240,73

## PORTABRIDAS - PARA ELECTROFUSIÓN

con junta plana

Sistemas: **aqualtherm green pipe, aqualtherm blue pipe**

Material: Fusiolen® PP-R & PP-RCT

Normas: DIN 16962, UNE EN ISO 15874

Color: verde

Nota: Pueden solicitarse más medidas si así se requiere  
Brida no incluida

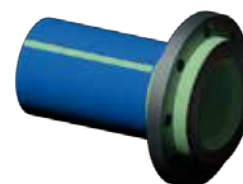

SDR	Art.-No.	Dimensión d [mm]	l	z	D	D1	l1	z1	Peso [kg]	Sistemas			Uds./ Paquete	Uds./Caja	Precio € m/pc
9	1023160000L	160	25,00	133,00	175,00	212	17,90	53,00	0,98	•			1		186,39
	1023200031L	200	32,00	270,00	232,00	268	22,40	72,00	2,00	•			1		366,11
	1023250032L	250	35,00	270,00	285,00	320	27,90	75,00	3,10	•			1		614,64
11	1054160030L	160	25,00	133,00	175,00	212	14,60	6,00	0,955	•			1		148,10
	1054200032L	200	32,00	270,00	232,00	268	18,20	6,00	1,957	•			1		281,65
	1054250034L	250	35,00	270,00	285,00	320	22,70	6,00	2,717	•			1		390,07
	2054160030L	160	25,00	133,00	175,00	212	14,60	6,00	0,955		•		1		148,10
	2054200032L	200	32,00	270,00	232,00	268	18,20	6,00	1,957		•		1		281,65
	2054250034L	250	35,00	270,00	285,00	320	22,70	6,00	2,717		•		1		390,07
17,6	2057160100L	160	25,00	133,00	175,00	212	9,10	3,00	0,821			•	1		134,14
	2057200101L	200	32,00	270,00	232,00	268	11,40	6,00				•	1		253,39
	2057250102L	250	35,00	270,00	285,00	320	14,20	6,00	2,736			•	1		350,16



**ENTRONQUE RECTO RH-H**

circular estriado

Sistemas: **aquatherm green pipe**, **aquatherm blue pipe**

Material: Fusiolen® PP-R, latón

Normas: DIN 16962, UNE EN ISO 15874

Color: verde

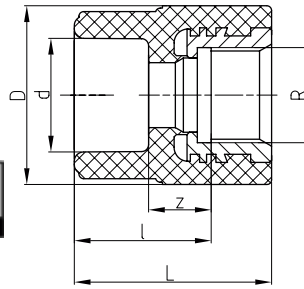

SDR	Art.-No.	d	R	l	z	D	L	Peso [kg]	Sistemas	Uds./Paquete	Uds./Caja	Precio € m/pc	
<b>Latón</b>													
6 7,4 9 11	1070016001	16	1/2"	28,00	15,00	38,50	41,00	0,066	• • •	10	400	5,43	
	1070020002	20	1/2"	27,50	13,00	37,50	40,50	0,064	• • •	10	400	5,43	
	1070020003	20	3/4"	27,50	13,00	43,50	40,50	0,089	• • •	10	300	6,74	
	1070025004	25	1/2"	29,00	13,00	37,50	42,00	0,065	• • •	10	400	5,43	
	1070025005	25	3/4"	27,50	11,50	43,50	40,50	0,087	• • •	10	300	6,74	
	1070032006	32	3/4"	30,50	12,50	43,50	43,50	0,092	• • •	5	250	8,36	
	<b>NUEVO Acero Inoxidable</b>												
	1070020060	20	1/2"	27,50	26,00	37,50	40,50	0,069	• • •	10	400	27,70	
	1070020061	20	3/4"	27,50	26,00	43,50	40,50	0,090	• • •	10	300	34,43	
	1070025062	25	1/2"	29,50	26,50	38,50	42,50	0,069	• • •	10	400	41,30	
	1070025063	25	3/4"	27,50	24,50	43,50	40,50	0,086	• • •	10	300	34,43	
1070032064	32	3/4"	30,50	25,50	43,50	43,50	0,092	• • •	5	200	34,75		
1070032065	32	1/2"	28,00	23,00	37,00	41,00	0,078	• • •	5	200	27,70		

**ENTRONQUE RECTO RH-H**

con cuello hexagonal

Sistemas: **aquatherm green pipe**, **aquatherm blue pipe**

Material: Fusiolen® PP-R, latón

Normas: DIN 16962, UNE EN ISO 15874

Color: verde

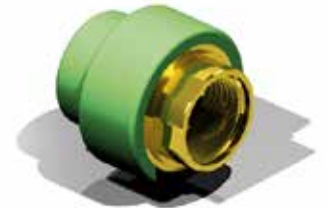
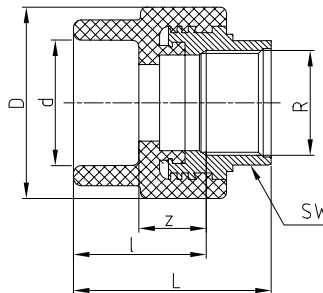

SDR	Art.-No.	d	R	l	z	D	L	SW	Peso [kg]	Sistemas	Uds./Paquete	Uds./Caja	Precio € m/pc
<b>Latón</b>													
6 7,4 9 11	1070016007	16	1/2"	34,50	21,50	38,50	50,50	24,00	0,089	• • •	10	400	7,98
	1070020008	20	1/2"	34,50	20,00	37,50	50,50	24,00	0,088	• • •	10	400	8,42
	1070020009	20	3/4"	29,00	14,50	43,50	50,00	31,00	0,112	• • •	10	300	9,35
	1070025010	25	1/2"	36,00	20,00	37,50	52,00	24,00	0,089	• • •	10	300	7,86
	1070025011	25	3/4"	29,00	13,00	43,50	50,00	31,00	0,109	• • •	10	300	9,23
	1070032012	32	3/4"	32,00	14,00	43,50	53,00	31,00	0,114	• • •	5	250	11,79
	1070032013	32	1"	37,50	19,50	60,00	59,50	39,00	0,239	• • •	5	125	19,40
	1070040014	40	1"	40,00	19,50	60,00	62,00	39,00	0,245	• • •	5	125	19,77
	1070040015	40	1 1/4"	40,00	19,50	74,00	63,00	50,00	0,385	• • •	5	80	34,56
	1070050016	50	1 1/4"	43,00	19,50	74,00	66,00	50,00	0,404	• • •	5	75	38,68
	1070050017	50	1 1/2"	45,00	21,50	85,50	67,00	55,00	0,424	• • •	5	60	41,92
	1070063018	63	1 1/2"	51,50	24,00	84,00	73,50	55,00	0,440	• • •	1	50	44,73
	1070063019	63	2"	50,00	22,50	101,00	76,00	67,00	0,589	• • •	1	35	64,13
	1070075020	75	2"	51,00	21,00	100,00	77,00	67,00	0,613	• • •	1	25	67,37
<b>NUEVO Acero inoxidable</b>													
1070032066	32	1"	37,50	41,50	60,00	59,50	39	0,232	• • •	5	150	58,26	
1070040067	40	1"	40,00	41,50	60,00	62,00	39	0,219	• • •	5	125	59,26	
1070040068	40	1 1/4"	40,00	42,50	74,00	63,00	50	0,331	• • •	5	80	91,58	
1070050069	50	1 1/4"	43,00	42,50	74,00	66,00	50	0,351	• • •	5	75	94,32	
1070050070	50	1 1/2"	45,00	43,50	84,00	67,00	55	0,445	• • •	5		114,21	
1070063071	63	1 1/2"	51,50	46,00	84,00	73,50	55	0,425	• • •	1	50	119,58	
1070063072	63	2"	51,00	49,50	101,00	77,00	67	0,196	• • •	1		269,36	
1070075073	75	2"	51,00	47,00	100,00	77,00	67	0,676	• • •	1	20	222,64	

**ENTRONQUE RECTO RM-H**

circular estriado, auto-sellado

Sistemas: **aquatherm green pipe, aquatherm blue pipe**

Material: Fusiolen® PP-R, latón

Normas: DIN 16962, UNE EN ISO 15874

Color: verde

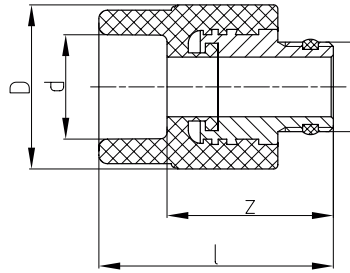

SDR	Art.-No.	d	R	l	z	D	Peso [kg]	Sistemas	Uds./ Paquete	Uds./Caja	Precio € m/pc
6											
7,4	<b>1070020051</b>	<b>20</b>	<b>1/2"</b>	52,50	38,00	38,50	0,090	• • •	10	400	<b>10,92</b>
11	<b>1070025052</b>	<b>25</b>	<b>1/2"</b>	54,00	38,00	38,50	0,091	• • •	10	350	<b>10,92</b>
	<b>1070025053</b>	<b>25</b>	<b>3/4"</b>	53,50	37,50	38,50	0,098	• • •	10	350	<b>13,04</b>

**ENTRONQUE RECTO RM - M**

con cuello hexagonal. autosellado macho / macho

Sistemas: **aquatherm green pipe, aquatherm blue pipe**

Material: Fusiolen® PP-R, latón

Normas: DIN 16962, UNE EN ISO 15874

Color: verde

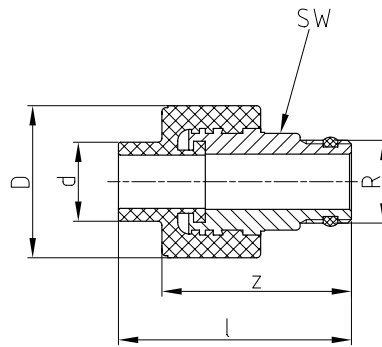

SDR	Art.-No.	d	R	l	z	D	Peso [kg]	Sistemas	Uds./ Paquete	Uds./Caja	Precio € m/pc
6											
7,4	<b>1070020054</b>	<b>20</b>	<b>1/2"</b>	59,00	48,00	38,50	0,107	• • •	10	300	<b>13,79</b>
11											

**ENTRONQUE RECTO RM - H**

con cuello hexagonal, autosellado hembra / macho

Sistemas: **aquatherm green pipe, aquatherm blue pipe**

Material: Fusiolen® PP-R, latón

Normas: DIN 16962, UNE EN ISO 15874

Color: verde

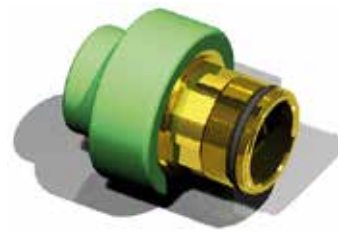
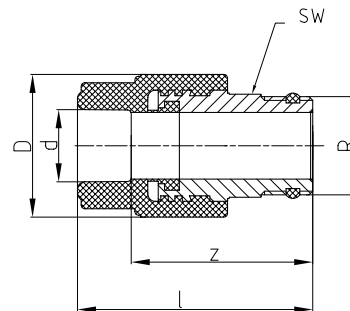

SDR	Art.-No.	d	R	l	z	D	Peso [kg]	Sistemas	Uds./ Paquete	Uds./Caja	Precio € m/pc
6											
7,4	<b>1070016055</b>	<b>16</b>	<b>1/2"</b>	63,50	50,50	38,50	0,112	• • •	10	300	<b>13,47</b>
11	<b>1070020056</b>	<b>20</b>	<b>1/2"</b>	63,50	49,00	38,50	0,111	• • •	10	300	<b>13,54</b>

**ENTRONQUE RECTO RM - H**

circular estriado

Sistemas: **aquatherm green pipe, aquatherm blue pipe**

Material: Fusiolen® PP-R, latón

Normas: DIN 16962, UNE EN ISO 15874

Color: verde

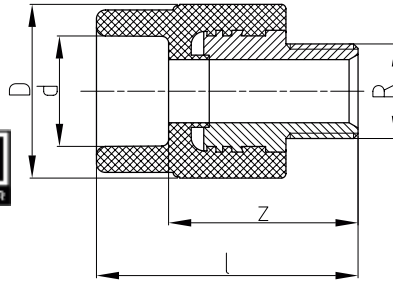

SDR	Art.-No.	d	R	l	z	D	Peso [kg]	Sistemas	Uds./ Paquete	Uds./Caja	Precio € m/pc	
6 7,4 9 11	<b>Latón</b>											
	1070016021	16	1/2"	56,50	43,50	38,50	0,097	•	10	400	6,61	
	1070020022	20	1/2"	56,50	42,00	38,50	0,097	• • •	10	350	6,61	
	1070020023	20	3/4"	57,50	43,00	38,50	0,109	• • •	10	300	7,86	
	1070025024	25	1/2"	58,00	42,00	38,50	0,098	• • •	10	300	6,61	
	1070025025	25	3/4"	57,50	41,50	38,50	0,107	• • •	10	300	7,86	
	1070032026	32	3/4"	59,50	41,50	43,00	0,115	• • •	5	250	9,11	
	<b>Acero Inoxidable</b>											
	1070020074	20	1/2"	56,50	42,00	38,50	0,096	• • •	10	400	29,88	
	1070020075	20	3/4"	57,50	43,00	38,50	0,108	• • •	10	300	35,12	
	1070025076	25	1/2"	58,00	42,00	38,50	0,098	• • •	10		28,63	
	1070025077	25	3/4"	57,50	41,50	38,50	0,108	• • •	10	350	33,75	
	1070032078	32	3/4"	59,50	41,50	38,50	0,115	• • •	5	200	34,06	

**ENTRONQUE RECTO RM - H**

con cuello hexagonal

Sistemas: **aquatherm green pipe, aquatherm blue pipe**

Material: Fusiolen® PP-R, latón

Normas: DIN 16962, UNE EN ISO 15874

Color: verde

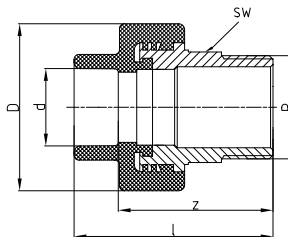

SDR	Art.-No.	d	R	l	z	D	Peso [kg]	Sistemas	Uds./ Paquete	Uds./Caja	Precio € m/pc	
6 7,4 9 11	<b>Latón</b>											
	1070016026	16	1/2"	66,50	53,50	38,50	0,119	•	10	300	9,35	
	1070020027	20	1/2"	66,50	52,00	38,50	0,104	• • •	10	300	9,35	
	1070020028	20	3/4"	67,50	53,00	38,50	0,129	• • •	10	300	12,53	
	1070025030	25	3/4"	67,50	51,50	38,50	0,103	• • •	10	300	12,53	
	1070032031	32	1"	78,50	60,50	53,00	0,216	• • •	5	125	18,28	
	1070032032	32	1 1/4"	81,00	63,00	68,00	0,320	• • •	5	100	31,07	
	1070040033	40	1"	81,00	60,50	52,00	0,222	• • •	5	100	20,34	
	1070040034	40	1 1/4"	84,50	64,00	68,00	0,326	• • •	5	80	34,18	
	1070050035	50	1 1/4"	85,50	62,00	68,00	0,352	• • •	5	75	37,30	
	1070050036	50	1 1/2"	88,50	65,00	74,00	0,429	• • •	5	60	45,54	
	1070063037	63	1 1/2"	94,50	67,00	72,50	0,466	• • •	1	40	51,65	
	1070063038	63	2"	102,50	75,00	84,00	0,679	• • •	1	35	60,64	
	1070075039	75	2"	102,00	72,00	84,00	0,729	• • •	1	25	64,38	
	1070075040	75	2 1/2"	105,00	75,00	100,00	0,972	• • •	1	25	87,89	
	1070090041	90	3"	121,00	88,00	120,00	1,315	• • •	1	20	134,12	
	1070110042	110	4"	148,00	111,00	147,00	2,699	• • •	1	8	216,65	
	<b>Acero Inoxidable</b>											
	1070032079	32	1"	78,50	60,50	53,00	0,204	• • •	5	125	75,17	
	1070032080	32	1 1/4"	81,00	63,00	68,00	0,360	• • •	5		104,55	
	1070040081	40	1"	81,00	60,50	52,00	0,251	• • •	5		75,98	
1070040082	40	1 1/4"	84,50	64,00	68,00	0,362	• • •	5		105,30		
1070050083	50	1 1/4"	85,50	62,00	68,00	0,389	• • •	5		108,30		
1070050084	50	1 1/2"	88,50	65,00	74,00	0,480	• • •	5		137,06		
1070063085	63	1 1/2"	94,50	67,00	72,50	0,523	• • •	1		143,16		
1070063086	63	2"	102,50	75,00	84,00	0,708	• • •	1		165,93		
1070075087	75	2"	102,00	72,00	84,00	0,699	• • •	1	25	168,42		

**ENTRONQUE CODO 90° RH - H**

Sistemas: **aquatherm green pipe**, **aquatherm blue pipe**

Material: Fusiolen® PP-R, latón

Normas: DIN 16962, UNE EN ISO 15874

Color: verde

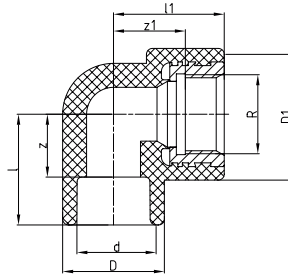

SDR	Art.-No.	d	R	l	z	D	l1	z1	D1	Peso [kg]	Sistemas	Uds./Paquete	Uds./Caja	Precio € m/pc		
<b>Latón</b>																
6 7,4 9 11	1070016090	16	1/2"	31,50	18,50	29,50	37,00	24,00	37,00	0,072	•	•	10	300	5,49	
	1070020091	20	3/4"	37,00	22,50	34,00	37,00	24,00	44,00	0,102	• • •	•	10	250	8,48	
	1070020092	20	1/2"	31,50	17,00	29,50	31,50	18,50	37,00	0,074	• • •	•	10	300	5,49	
	1070025093	25	3/4"	37,00	21,00	34,00	37,00	24,00	44,00	0,100	• • •	•	10	200	8,48	
	1070025094	25	1/2"	34,00	18,00	34,00	37,00	24,00	37,00	0,074	• • •	•	10	250	5,49	
	1070032095	32	3/4"	27,50	9,50	43,00	51,00	38,00	44,00	0,104	• • •	•	5	150	10,11	
	1070032096	32	1"	34,00	16,00	43,00	66,50	44,50	60,50	0,251	• • •	•	5	100	21,33	
	1050032010	40	3/4"								0,148	• • •				13,91
	<b>Acero Inoxidable</b>															
	1070020110	20	3/4"	37,00	22,50	29,50	37,00	24,00	37,00	37,00	0,095	• • •	•	10	300	35,12
	1070020111	20	1/2"	31,00	16,50	29,50	31,50	18,50	37,00	37,00	0,081	• • •	•	10	300	24,27
1070025112	25	3/4"	37,00	21,00	34,00	37,00	24,00	44,00	44,00	0,101	• • •	•	10	200	35,12	
1070025113	25	1/2"	33,50	17,5	34,00	31,50	18,5	37,00	37,00	0,082	• • •	•	10	250	24,27	
1070032114	32	1/2"	35,00	17,00	43,00	37,00	24,00	37,00	37,00	0,112	• • •	•	5		27,20	
1070032115	32	3/4"	27,50	9,50	43,00	51,00	38,00	44,00	44,00	0,097	• • •	•	5	150	37,18	
1070032116	32	1"	34,00	16,00	43,00	66,50	44,50	60,50	60,50	0,240	• • •	•	5	100	61,51	

**ENTRONQUE CODO 90° RH - M**

Sistemas: **aquatherm green pipe**, **aquatherm blue pipe**

Material: Fusiolen® PP-R, latón

Normas: DIN 16962, UNE EN ISO 15874

Color: verde

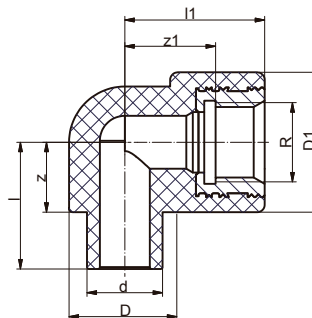

SDR	Art.-No.	d	R	l	z	D	l1	z1	D1	Peso [kg]	Sistemas	Uds./Paquete	Uds./Caja	Precio € m/pc
6 7,4 11														
	1070020097	20	1/2"	33,50	18,50	29,50	37,00	24,00	37,00	0,076	• • •	•	10	300

## ENTRONQUE CODO 90° RM - H

Sistemas: **aquatherm green pipe**, **aquatherm blue pipe**

Material: Fusiolen® PP-R, latón

Normas: DIN 16962, UNE EN ISO 15874

Color: verde

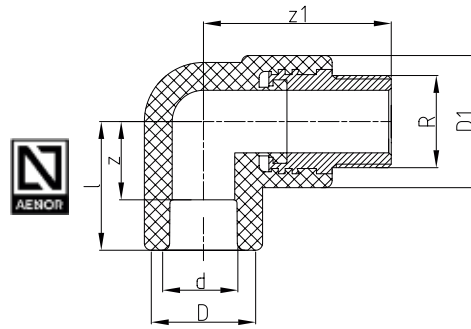

SDR	Art.-No.	d	R	l	z	D	z1	D1	Peso [kg]	Sistemas	Uds./Paquete	Uds./Caja	Precio € m/pc
6 7,4 9 11	<b>Latón</b>												
	1070016098	16	1/2"	31,50	18,50	29,50	53,00	37,00	0,109	• • •	10	400	7,61
	1070020099	20	1/2"	31,50	17,00	29,50	53,00	37,00	0,108	• • •	10	250	7,61
	1070020100	20	3/4"	37,00	22,50	34,00	54,00	38,00	0,128	• • •	10	200	9,29
	1070025101	25	3/4"	37,00	21,00	34,00	54,00	38,00	0,105	• • •	10	250	9,29
	1070032102	32	3/4"	27,50	9,50	43,00	68,00	38,00	0,112	• • •	5	150	11,54
	1070032103	32	1"	31,00	13,00	43,00	85,50	52,00	0,233	• • •	5	100	20,46
	<b>NUEVO Acero Inoxidable</b>												
	1070020117	20	1/2"	31,50	17,00	29,50	53,00	37,00	0,035	• • •	10		30,50
	1070020118	20	3/4"	31,50	17,00	34,00	54,00	38,00	0,123	• • •	10	200	36,43
	1070025119	25	3/4"	31,50	15,50	34,00	54,00	38,00	0,121	• • •	10	250	36,43
	1070032120	32	3/4"	27,50	9,50	43,00	68,00	38,00	0,128	• • •	5	150	39,18

## T DE TRANSICIÓN RH

Sistemas: **aquatherm green pipe**, **aquatherm blue pipe**

Material: Fusiolen® PP-R, latón

Normas: DIN 16962, UNE EN ISO 15874

Color: verde

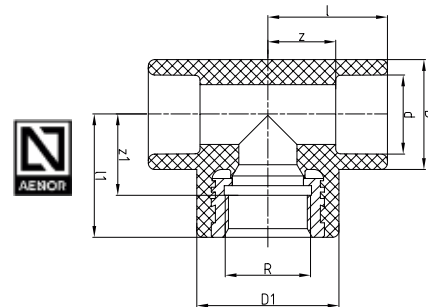

SDR	Art.-No.	d	R	l	z	D	l1	z1	D1	Weight [kg]	System	PU	Box unit	Price € m/pc
6 7,4 9 11	<b>Latón</b>													
	1060016140	16	1/2"	31,50	18,50	29,50	37,00	24,00	37,00	0,089	• • •	10	250	7,36
	1060020141	20	1/2"	31,50	17,00	29,50	37,00	24,00	37,00	0,086	• • •	10	250	7,42
	1060020142	20	3/4"	37,00	22,50	34,00	37,00	24,00	44,00	0,121	• • •	10	170	7,74
	1060025143	25	1/2"	34,50	18,50	34,00	38,00	25,00	37,00	0,090	• • •	10	200	7,36
	1060025144	25	3/4"	37,00	21,00	34,00	37,00	24,00	44,00	0,109	• • •	10	150	9,17
	1060032145	32	1/2"	35,00	17,00	43,00	37,00	24,00	37,00	0,103	• • •	5	125	10,98
	1060032146	32	3/4"	27,50	9,50	43,00	51,00	38,00	44,00	0,111	• • •	5	100	11,42
	1060032147	32	1"	31,50	13,50	43,00	67,00	45,00	60,00	0,255	• • •	5	80	21,89
	1060040148	40	1/2"	41,50	21,00	52,00	40,00	27,00	37,00	0,142	• • •	5		11,48
	1060040149	40	3/4"	40,50	20,00	52,00	40,50	27,50	52,00	0,147	• • •	5		18,46
	1060040150	40	1"	41,50	21,00	52,00	56,00	34,00	60,00	0,276	• • •	5	80	22,64
	1060050151	50	1"	49,50	26,00	68,00	63,50	41,50	68,30	0,385	• • •	5	40	25,95
	1060050152	50	1/2"	49,50	26,00	68,00	44,50	31,50	43,00	0,237	• • •	5		18,09
	1060050153	50	3/4"	49,50	26,00	68,00	44,50	31,50	43,00	0,243	• • •	5		20,90
	<b>NUEVO Acero Inoxidable</b>													
	1060020160	20	1/2"	31,50	17,00	29,50	37,00	24,00	37,00	0,087	• • •	10	250	27,39
	1060020161	20	3/4"	37,00	22,50	34,00	37,00	24,00	44,00	0,108	• • •	10		28,94
	1060025162	25	1/2"	34,50	18,50	34,00	38,00	25,00	37,00	0,093	• • •	10	200	26,82
	1060025163	25	3/4"	37,00	21,00	34,00	37,00	24,00	44,00	0,111	• • •	10	150	34,68
	1060032164	32	1/2"	35,00	17,00	43,00	37,00	24,00	37,00	0,113	• • •	5	125	29,51
1060032165	32	3/4"	27,50	9,50	43,00	51,00	38,00	44,00	0,111	• • •	5	100	37,92	
1060032166	32	1"	31,50	13,50	43,00	67,00	45,00	60,00	0,082	• • •	5		60,45	

**T DE TRANSICIÓN RM**

Sistemas: **aquatherm green pipe, aquatherm blue pipe**  
 Material: Fusiolen® PP-R, latón  
 Normas: DIN 16962, UNE EN ISO 15874  
 Color: verde

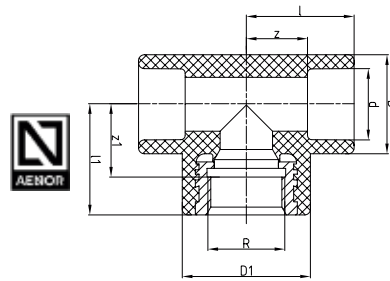

SDR	Art.-No.	d	R	l	z	D	z1	D1	Peso [kg]	Sistemas	Uds./Paquete	Uds./Caja	Precio € m/pc
6 7,4 11	<b>1060020154</b>	<b>20</b>	<b>1/2"</b>	31,50	17,00	29,50	53,00	37,00	0,102	• • •	10	200	<b>9,54</b>

**RACOR RECTO DESMONTABLE RM**

con tuerca de unión y soldadura a enchufe

Sistemas: **aquatherm green pipe, aquatherm blue pipe**  
 Material: Fusiolen® PP-R, latón  
 Normas: DIN 16962, UNE EN ISO 15874  
 Color: verde

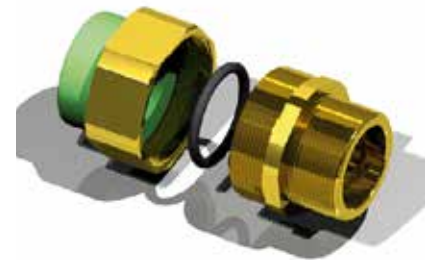
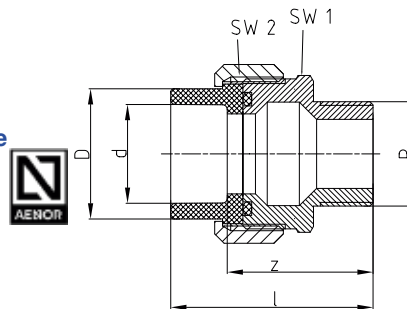

SDR	Art.-No.	d	R	l	z	D	SW1	SW2	Peso [kg]	Sistemas	Uds./Paquete	Uds./Caja	Precio € m/pc
6 7,4 9 11	<b>1050020070</b>	<b>20</b>	<b>1/2"</b>	54,50	40,00	27,50	36,00	36,00	0,145	• • •	1	250	<b>21,71</b>
	<b>1050025071</b>	<b>25</b>	<b>3/4"</b>	59,50	43,50	36,00	46,00	46,00	0,243	• • •	1	150	<b>31,94</b>
	<b>1050032072</b>	<b>32</b>	<b>1"</b>	64,50	46,50	41,50	52,00	50,00	0,336	• • •	1	150	<b>40,11</b>
	<b>1050040073</b>	<b>40</b>	<b>1 1/4"</b>	70,00	49,50	53,00	64,00	65,00	0,632	• • •	1	80	<b>81,16</b>
	<b>1050050074</b>	<b>50</b>	<b>1 1/2"</b>	86,50	63,00	59,00	72,00	57,00	0,624	• • •	1	60	<b>102,80</b>
	<b>1050063075</b>	<b>63</b>	<b>2"</b>	95,50	68,00	74,00	89,00	66,00	1,212	• • •	1	35	<b>154,95</b>

**RACOR RECTO DESMONTABLE RH**

con tuerca de unión y soldadura a enchufe

Sistemas: **aquatherm green pipe, aquatherm blue pipe**  
 Material: Fusiolen® PP-R, latón  
 Normas: DIN 16962, UNE EN ISO 15874  
 Color: verde

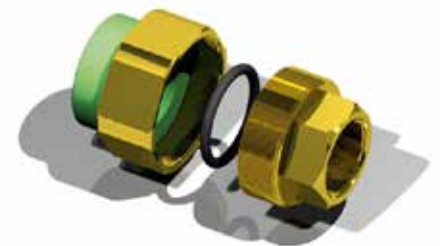
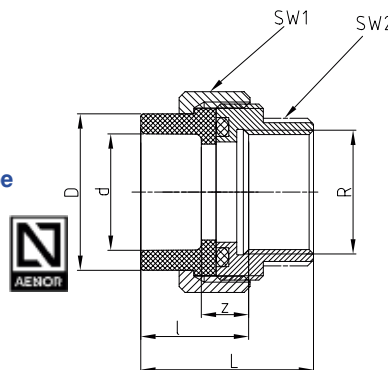

SDR	Art.-No.	d	R	l	z	D	L	SW1	SW2	Peso [kg]	Sistemas	Uds./Paquete	Uds./Caja	Precio € m/pc
6 7,4 9 11	<b>1050020076</b>	<b>20</b>	<b>1/2"</b>	30,00	15,50	27,50	45,00	36,00	25,00	0,083	• • •	1	300	<b>22,40</b>
	<b>1050025077</b>	<b>25</b>	<b>3/4"</b>	32,00	16,00	36,00	49,00	45,00	32,00	0,193	• • •	1	120	<b>31,50</b>
	<b>1050032078</b>	<b>32</b>	<b>1"</b>	37,00	19,00	41,50	54,00	52,00	40,00	0,291	• • •	1	100	<b>38,86</b>
	<b>1050040079</b>	<b>40</b>	<b>1 1/4"</b>	36,50	16,00	53,00	58,50	64,00	47,00	0,423	• • •	1	100	<b>81,91</b>
	<b>1050050080</b>	<b>50</b>	<b>1 1/2"</b>	45,50	22,00	59,00	64,50	72,00	57,00	0,610	• • •	1	60	<b>100,18</b>
	<b>1050063081</b>	<b>63</b>	<b>2"</b>	50,50	23,00	74,00	74,50	89,00	68,00	0,924	• • •	1	50	<b>156,08</b>

**Aviso:** los accesorios metálicos aquatherm green pipe son fabricados con PP-R fusiolen y latón. También están disponibles en acero inoxidable para 1/2" y 3/4" sin cuello hexagonal.

**UNIÓN TUERCA MOVIL**

Longitud: 100 mm, con junta plana

Sistemas: **aquatherm green pipe, aquatherm blue pipe**

Material: Fusiolen® PP-R, latón

Normas: DIN 16962, UNE EN ISO 15874

Color: verde

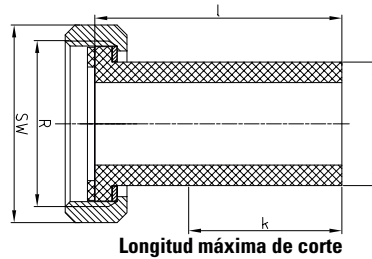

Longitud máxima de corte

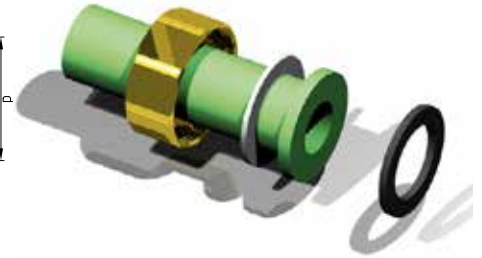

SDR	Art.-No.	d	Rosca	l	k	SW	Peso [kg]	Sistemas	Uds./ Paquete	Uds./Caja	Precio € m/pc
6 7,4 9 11	1050020082	20	1"	100,00	65,00	36,00	0,079	• • •	1	150	12,85
	1050025083	25	1 1/4"	100,00	62,00	46,00	0,104	• • •	1	125	15,47
	1050032084	32	1 1/2"	100,00	58,00	52,00	0,175	• • •	1	100	17,40
	1050040085	40	2"	100,00	53,00	64,00	0,258	• • •	1	75	28,07

**RACOR LOCO CIRCULAR ESTRIADO**

circular estriado, con junta plana

Sistemas: **aquatherm green pipe, aquatherm blue pipe**

Material: Fusiolen® PP-R, latón

Normas: DIN 16962, UNE EN ISO 15874

Color: verde

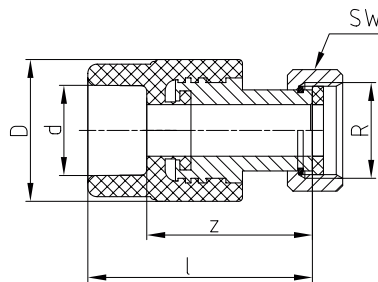

SDR	Art.-No.	d	Rosca	l	z	D	SW	Peso [kg]	Sistemas	Uds./ Paquete	Uds./Caja	Precio € m/pc
6 7,4 9 11	1050020090	20	3/4"	59,50	45,00	38,50	30,00	0,153	• • •	1	250	23,58
	1050025091	25	3/4"	61,00	45,00	38,50	30,00	0,155	• • •	1	250	28,51
	1050032092	32	3/4"	62,00	44,00	43,50	30,00	0,162	• • •	1	200	32,25
	1050032010	32	1"					0,206	• • •	1		30,13

**RACOR LOCO CUELLO HEXAGONAL**

con cuello hexagonal. Según Norma ISO

Sistemas: **aquatherm green pipe, aquatherm blue pipe**

Material: Fusiolen® PP-R, latón

Normas: DIN 16962, UNE EN ISO 15874

Color: verde

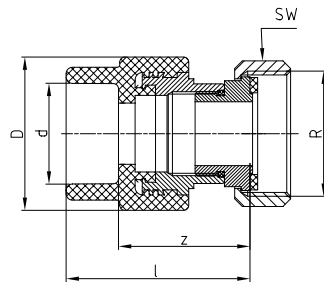

SDR	Art.-No.	d	Rosca	L	z	D	SW	Peso [kg]	Sistemas	Uds./ Paquete	Uds./Caja	Precio € m/pc
6 7,4 9 11	1050020097	20	1"	58,50	36,00	38,50	36,00	0,182	• • •	10	300	28,20
	1050025098	25	1"	60,00	44,00	38,50	36,00	0,186	• • •	10	300	28,20
	1050025099	25	1 1/4"	60,00	44,00	43,50	46,00	0,274	• • •	10	250	34,06
	1050032100	32	1 1/4"	63,00	45,00	43,50	46,00	0,279	• • •	5	175	34,87
	1050032101	32	1 1/2"	69,50	51,50	60,00	52,00	0,446	• • •	5	125	48,41
	1050040102	40	1 1/2"	72,00	51,50	60,00	52,00	0,421	• • •	5	100	50,78
	1050040103	40	2"	74,00	53,50	74,00	64,00	0,719	• • •	5	70	95,38
	1050050104	50	2"	77,00	53,50	74,00	64,00	0,736	• • •	5	70	99,93
	1050050105	50	2 1/4"	77,00	54,50	84,00	72,00	0,831	• • •	5	50	120,83
	1050063106	63	2 1/4"	83,50	56,00	84,00	72,00	0,889	• • •	1	45	122,83
	1050063107	63	2 3/4"	84,00	56,50	101,00	89,00	1,306	• • •	1	30	171,17
	1050075108	75	2 3/4"	85,00	55,00	100,00	89,00	1,275	• • •	1	30	171,17
	1050075109	75	3 1/2"	91,00	61,00	100,00	110,00	1,818	• • •	1	30	209,23

## ELEMENTOS DE TRANSICIÓN

### RACOR RECTO CON ENLACE RM

con soldadura a enchufe y rosca macho. Según Norma ISO

Sistemas: **aquatherm green pipe, aquatherm blue pipe**  
 Material: Fusiolen® PP-R, latón  
 Normas: DIN 16962, UNE EN ISO 15874  
 Color: verde

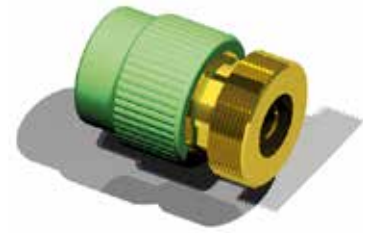
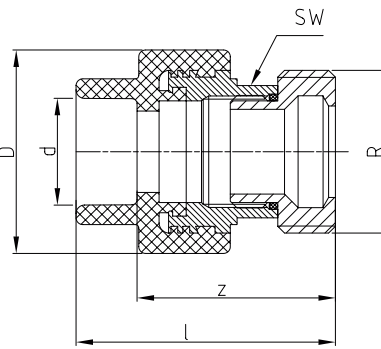

SDR	Art.-No.	d	Rosca	l	z	D	SW	Peso [kg]	Sistemas	Uds./Paquete	Uds./Caja	Precio € m/pc
6 7,4 9 11	1050020110	20	1"	61,50	47,00	38,50	24,00	0,151	• • •	10	300	32,81
	1050025111	25	1"	63,00	47,00	38,50	24,00	0,153	• • •	10	300	32,81
	1050025112	25	1 1/4"	63,00	47,00	43,50	31,00	0,221	• • •	10	250	38,74
	1050032113	32	1 1/4"	66,00	48,00	43,50	31,00	0,226	• • •	5	175	38,74
	1050032114	32	1 1/2"	76,50	58,50	60,00	39,00	0,408	• • •	5	125	63,63
	1050040115	40	1 1/2"	79,00	58,50	60,00	39,00	0,414	• • •	5	125	66,68
	1050040116	40	2"	81,00	60,50	74,00	50,00	0,650	• • •	5	70	89,33
	1050050117	50	2"	84,00	60,50	74,00	50,00	0,634	• • •	5	70	98,50
	1050050118	50	2 1/4"	83,00	59,50	84,00	55,00	0,750	• • •	5	50	115,40
	1050063119	63	2 1/4"	89,50	62,00	84,00	55,00	0,728	• • •	1	45	121,27
	1050063120	63	2 3/4"	94,00	66,50	101,00	67,00	1,093	• • •	1	30	163,69
	1050075121	75	2 3/4"	95,00	65,00	100,00	67,00	1,117	• • •	1	30	165,24
1050075122	75	3 1/2"	100,00	70,00	100,00	67,00	1,436	• • •	1	30	213,72	

### ENLACE DE LATÓN PARA RACORES

con rosca macho-hembra. Según Norma ISO

Sistemas: **aquatherm green pipe, aquatherm blue pipe**  
 Material: Fusiolen® PP-R, latón  
 Color: verde

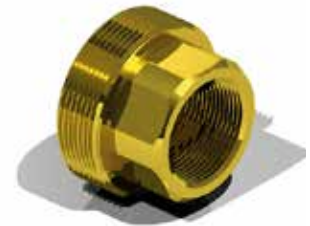
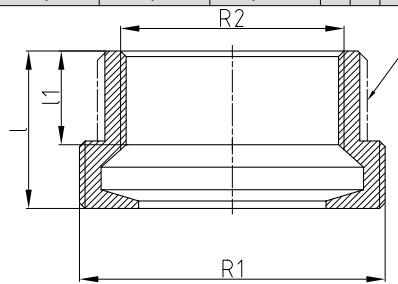

SDR	Art.-No.	Rosca macho	Rosca hembra	l	l1	SW	Peso [kg]	Sistemas	Uds./Paquete	Uds./Caja	Precio € m/pc
6 7,4 9 11	1050000130	1"	1/2"	25,00	15,00	25,00	0,063	• • •	10	400	23,08
	1050000131	1 1/4"	3/4"	28,00	18,00	32,00	0,119	• • •	10	200	26,89
	1050000132	1 1/2"	1"	31,00	17,00	40,00	0,175	• • •	5	125	33,75
	1050000133	2"	1 1/4"	33,00	22,00	47,00	0,263	• • •	5	75	46,54
	1050000134	2 1/4"	1 1/2"	36,00	19,00	57,00	0,333	• • •	5	60	63,63
	1050000135	2 3/4"	2"	42,00	24,00	68,00	0,517	• • •	1	35	82,28
	9600027522	3 1/2"	2 1/2"	46,00	27,00	84,00	0,801	• • •	1	25	95,51
	9600027524	4"	3"	46,00	27,00	97,00	0,943	• • •	1	25	178,91



**ENLACE DE LATÓN PARA RACORES**

con rosca macho. Según Normas ISO

Sistemas: **aquatherm green pipe, aquatherm blue pipe**  
 Material: latón  
 Color: verde

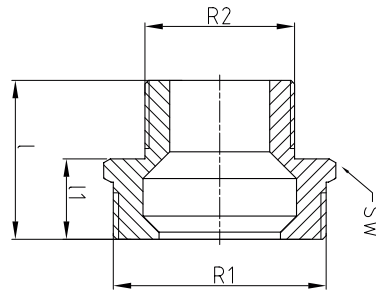

SDR	Art.-No.	Rosca 1	Rosca 2	l	l1	SW	Peso [kg]	Sistemas	Uds./ Paquete	Uds./Caja	Precio € m/pc
6 7,4 9 11	<b>1050000138</b>	<b>1"</b>	<b>1/2"</b>	34,50	18,50	36,00	0,109	• • •	10	250	<b>22,02</b>
	<b>1050000139</b>	<b>1 1/4"</b>	<b>3/4"</b>	38,50	21,00	46,00	0,188	• • •	10	140	<b>29,51</b>
	<b>1050000140</b>	<b>1 1/2"</b>	<b>1"</b>	41,50	22,50	50,00	0,211	• • •	5	100	<b>36,24</b>
	<b>1050000141</b>	<b>2"</b>	<b>1 1/4"</b>	44,50	22,50	65,00	3,630	• • •	5	60	<b>59,70</b>
	<b>1050000142</b>	<b>2 1/4"</b>	<b>1 1/2"</b>	58,00	36,00	57,00	0,472	• • •	5	50	<b>78,79</b>
	<b>1050000143</b>	<b>2 3/4"</b>	<b>2"</b>	63,00	38,00	66,00	0,803	• • •	1	25	<b>103,24</b>
	<b>9600027722</b>	<b>3 1/2"</b>	<b>2 1/2"</b>	70,00	42,00	82,00	1,189	• • •	1	15	<b>124,33</b>
	<b>9600027724</b>	<b>4"</b>	<b>3"</b>	74,00	42,00	97,00	1,398	• • •	1	10	<b>204,67</b>

**CODO PLACA DE SUPERFICIE RH**

Sistemas: **aquatherm green pipe, aquatherm blue pipe**  
 Material: Fusiolen® PP-R, latón  
 Normas: DIN 16962, UNE EN ISO 15874  
 Color: verde

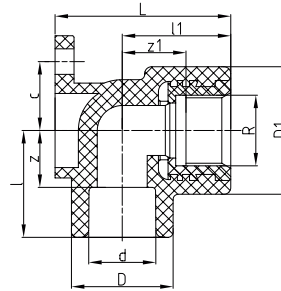

SDR	Art.-No.	d	R	l	z	D	l1	z1	D1	L	c	Peso [kg]	Sistemas	Uds./ Paquete	Uds./ Caja	Precio € m/pc	
<b>Latón</b>																	
6 7,4 11	<b>1040016150</b>	<b>16</b>	<b>1/2"</b>	31,00	18,00	29,50	31,50	15,50	37,00	51,00	20,00	0,080	• • •	10	200	<b>5,99</b>	
	<b>1040020151</b>	<b>20</b>	<b>1/2"</b>	31,00	16,50	29,50	31,50	15,50	37,00	51,00	20,00	0,079	• • •	10	200	<b>5,99</b>	
	<b>1040020152</b>	<b>20</b>	<b>3/4"</b>	37,00	22,50	34,00	37,00	24,00	44,00	54,00	25,00	0,102	• • •	10	150	<b>8,92</b>	
	<b>1040025153</b>	<b>25</b>	<b>3/4"</b>	33,50	17,50	34,00	31,00	15,00	37,00	53,00	20,00	0,081	• • •	10	200	<b>8,92</b>	
	<b>1040025154</b>	<b>25</b>	<b>1/2"</b>	37,00	21,00	34,00	37,00	24,00	44,00	54,00	25,00	0,105	• • •	10	150	<b>5,99</b>	
	<b>Acero Inoxidable</b>																
	<b>1090020070</b>	<b>20</b>	<b>1/2"</b>	31,00	16,50	29,50	31,50	18,50	37,00	51,00	20,00	0,084	• • •	10		<b>26,76</b>	
	<b>1090020071</b>	<b>20</b>	<b>3/4"</b>	37,00	22,50	34,00	37,00	24,00	44,00	54,00	-	0,101	• • •	10		<b>36,12</b>	
<b>1090025072</b>	<b>25</b>	<b>3/4"</b>	33,50	17,50	34,00	31,00	18,00	37,00	53,00	20,00	0,076	• • •	10		<b>36,12</b>		
<b>1090025073</b>	<b>25</b>	<b>1/2"</b>	37,00	21,00	34,00	37,00	24,00	44,00	54,00	-	0,111	• • •	10		<b>26,76</b>		

**CODO PLACA SEMIEMPOTRABLE RH - PARA PARED DE YESO LAMINADO**

Sistemas: **aquatherm green pipe aquatherm blue pipe**  
 Material: Fusiolen® PP-R, latón  
 Normas: DIN 16962, UNE EN ISO 15874  
 Color: verde

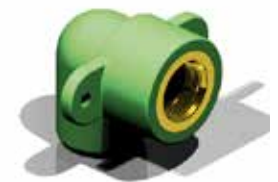
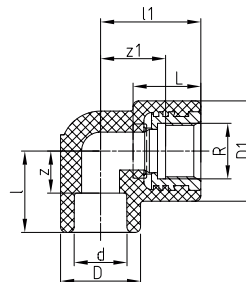

SDR	Art.-No.	d	R	l	z	D	l1	z1	D1	L	c	Peso [kg]	Sistemas	Uds./ Paquete	Uds./ Caja	Precio € m/pc
<b>Soldadura a enchufe</b>																
6 7,4 11	<b>1040016155</b>	<b>16</b>	<b>1/2"</b>	30,00	17,00	29,50	37,00	24,00	37,00	25,00	59,00	0,079	• • •	10	250	<b>8,11</b>
	<b>1040020156</b>	<b>20</b>	<b>1/2"</b>	30,00	15,50	29,50	37,00	24,00	37,00	25,00	59,00	0,079	• • •	10	200	<b>8,23</b>

accesorios PPR mixtos

**PRINCIPIOS DEL CODO PLACA DOBLE CON PASO DE CAUDAL**

El codo placa doble de paso de caudal se desarrolla en cumplimiento del Código Técnico de la Edificación ya que presenta diversas ventajas frente a los sistemas de instalación convencionales de tubería para el suministro de agua. Entre ellos destacan los siguientes.

- Evita estancamientos de agua en las tomas no utilizadas habitualmente.
- No cabe la posibilidad de retornos a la red.
- Permite la instalación de tuberías empotradas por debajo del nivel de la toma de agua en pared y suelo.
- Diseño compacto y de rápida instalación gracias al alto grado de prefabricación.

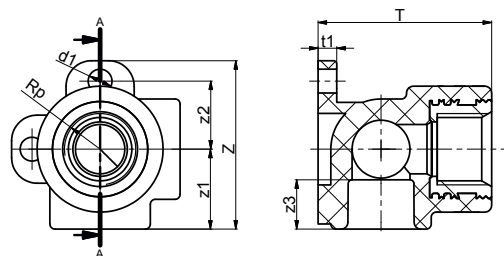

**aquatherm green pipe CODO PLACA DOBLE PASO DE CAUDAL FLUJO A 90°**

Art.- No.	Dimensión	d1	Z	z1	z2	z3	t1	T	Rp	Uds.	Uds./caja	Precio € m/pc
<b>1090020031</b>	20 mm x 1/2" f x 20 mm	7,00	49,50	23,50	20,00	14,50	5,50	51,00	1/2"	1		<b>20,40</b>

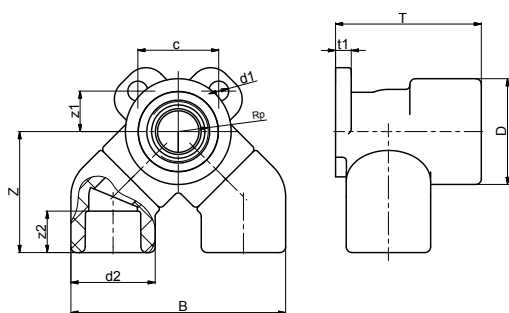

**aquatherm green pipe CODO PLACA DOBLE PASO DE CAUDAL FLUJO PARALELO**

Art.- No.	Dimension	D	d1	d2	Z	z1	z2	t1	T	c	Uds.	Uds./caja	Precio € m/pc
<b>1050020015</b>	20 mm x 1/2" f x 20 mm	37,00	7,00	29,50	42,30	14,14	14,50	5,50	51,00	28,11	1		<b>34,75</b>

### ENTRONQUE RECTO RM/RH

con arandela, contratuerca, junta y tensor

Sistemas: **aqualtherm green pipe** **aqualtherm blue pipe**  
 Material: Fusiolen® PP-R, latón  
 Normas: DIN 16962, UNE EN ISO 15874  
 Color: verde

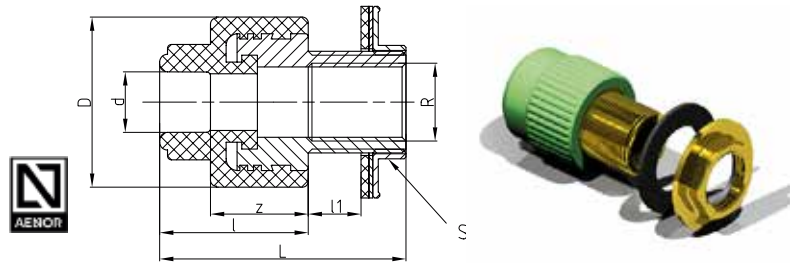

SDR	Art.-No.	d	R	l	z	D	l1	L	SW	Peso [kg]	Sistemas	Uds./ Paquete	Uds./Caja	Precio € m/pc
6	Soldadura a enchufe													
7,4	<b>1050020060</b>	<b>20</b>	<b>1/2"</b>	40,00	25,50	43,50	13,50	65,00	29,00	0,204	• • •	10	200	<b>15,22</b>
11														

e.g. para conexión a cisternas.

### ENTRONQUE CODO RM/RH

con arandela, contratuerca, junta y tensor

Sistemas: **aqualtherm green pipe** **aqualtherm blue pipe**  
 Material: Fusiolen® PP-R, latón  
 Normas: DIN 16962, UNE EN ISO 15874  
 Color: verde

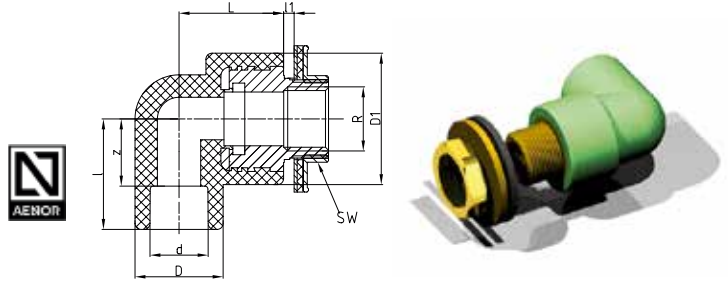

SDR	Art.-No.	d	R	l	z	D	l1	L	D1	SW	Peso [kg]	Sistemas	Uds./ Paquete	Uds./Caja	Precio € m/pc
6	Soldadura a enchufe														
7,4	<b>1050016061</b>	<b>16</b>	<b>1/2"</b>	37,00	24,00	29,50	3,50	35,00	44,00	29,00	0,201	• • •	10	200	<b>22,77</b>
11	<b>1050020062</b>	<b>20</b>	<b>1/2"</b>	37,00	22,50	29,50	3,50	35,00	44,00	29,00	0,154	• • •	10	200	<b>22,77</b>
	<b>1050025063</b>	<b>25</b>	<b>1/2"</b>	37,00	21,00	34,00	3,50	37,00	44,00	29,00	0,206	• • •	10	150	<b>22,77</b>

p.e. para conexión a cisterna con placa de montaje (Art.-No. 60110-60115)

### ENTRONQUE CODO RM-H

para placas de yeso laminado

Sistemas: **aqualtherm green pipe**, **aqualtherm blue pipe**  
 Material: Fusiolen® PP-R, latón  
 Color: verde

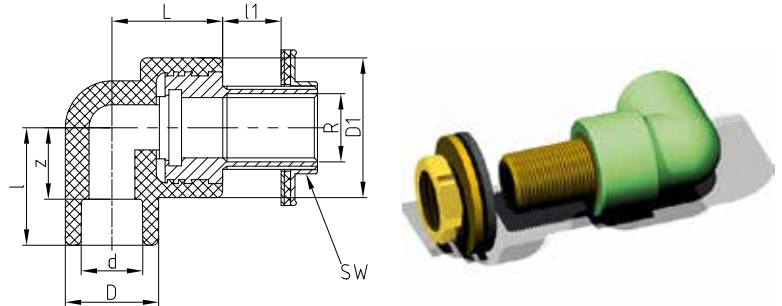

SDR	Art.-No.	d	R	l	z	D	L	l1	D1	SW	Peso [kg]	Sistemas	Uds./ Paquete	Uds./Caja	Precio € m/pc
6	Soldadura a enchufe														
7,4	<b>1050020064</b>	<b>20</b>	<b>1/2"</b>	37,00	22,50	29,50	35,00	18,50	44,00	29,00	0,223	• • •	10	200	<b>23,95</b>
11															

con rosca de 30 mm, arandela, contratuerca, junta y tensor

### PASAMUROS DE LATÓN - PARA PARED DE YESO LAMINADO

Sistemas: **aqualtherm green pipe** **aqualtherm blue pipe**  
 Material: latón

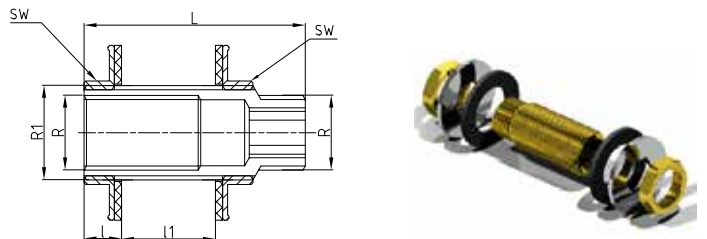

Art.-No.	R	R1	l	l1	L	SW	Peso [kg]	Sistemas	Uds./ Paquete	Uds./Caja	Precio € m/pc
<b>9600020114</b>	<b>1/2"</b>	<b>3/4"</b>	10,50	26,00	62,00	30,00	0,213	• • •	10	300	<b>19,65</b>

## ELEMENTOS DE TRANSICIÓN

### NIVEL

con 2 conexiones de 1/2"

Sistemas: **aquatherm green pipe** **aquatherm blue pipe**

Material: Fusiolen® PP-R

Color: verde



Art.-No.	a	b	h1	l1	l2	d	l	R	Peso [kg]	Sistemas	Uds./ Paquete	Uds./Caja	Precio € m/pc
<b>9800050700</b>	280,00	36,00	8,00	80,00	250,00	28	55,50	1/2"	0,252	• • •	1		<b>25,45</b>

### TAPÓN PARA PRUEBAS DE PRESIÓN

Sistemas: **aquatherm green pipe** **aquatherm blue pipe**

Material: Fusiolen® PP-R

Normas: DIN 16962, UNE EN ISO 15874

Color: verde

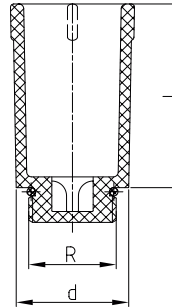

Art.-No.	d	R	l	Peso [kg]	Sistemas	Uds./ Paquete	Uds./Caja	Precio € m/pc
<b>9800050708</b>	28	1/2"	55,50	0,022	• • •	10		<b>0,91</b>
<b>9800050710</b>	34	3/4"	55,50	0,027	• • •	10		<b>1,24</b>

### SALVATUBOS

Sistemas: **aquatherm green pipe**, **aquatherm blue pipe**

Material: Fusiolen® PP-R

Normas: DIN 16962, UNE EN ISO 15874

Color: verde

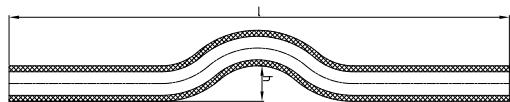

SDR	Art.-No.	Dimensión d [mm]	h	l	Peso [kg]	Sistemas	Uds./ Paquete	Uds./Caja	Precio € m/pc	
6 7,4 9 11	Soldadura a enchufe									
	<b>1090016001</b>	<b>16</b>	17,00	352,00	0,038	• • •	10	600	<b>2,74</b>	
	<b>1090020002</b>	<b>20</b>	22,00	352,00	0,060	• • •	10	400	<b>2,99</b>	
	<b>1090025003</b>	<b>25</b>	25,00	352,00	0,091	• • •	10	250	<b>4,62</b>	
	<b>1090032004</b>	<b>32</b>	32,00	352,00	0,154	• • •	5	120	<b>6,99</b>	

### BLOQUE DISTRIBUIDOR

Incluidos un tapón y dos cierres

Sistemas: **aquatherm green pipe**, **aquatherm blue pipe**

Material: Fusiolen® PP-R

Color: verde

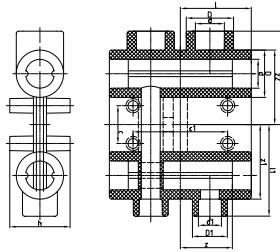

SDR	Art.-No.	d	l	z	D	d1	l1	z1	D1	l2	z2	c	c1	cl	l3	h	Peso [kg]	Sistemas	Uds./Paquete	Uds./Caja	Precio € m/pc
6																					
7,4	<b>1050025016</b>	<b>25</b>	60,00	44,00	40,00	20	77,50	63,00	29,50	79,00	63,00	32,00	80,00	100,00	36,00	51,00	0,273	• • •	1	50	<b>25,83</b>
11																					

### COLECTOR

Longitud: 246 mm, con 4 salidas

Sistemas: **aquatherm green pipe**, **aquatherm blue pipe**

Material: Fusiolen® PP-R

Color: verde

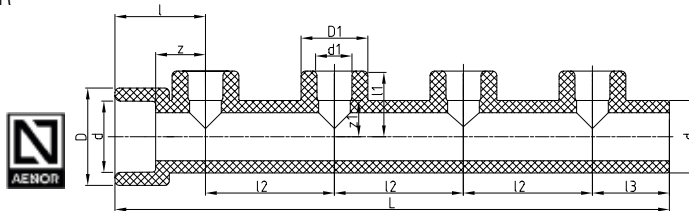

SDR	Art.-No.	d	d1	l	z	D	l1	z1	D1	l2	l3	L	Peso [kg]	Sistemas	Uds./Paquete	Uds./Caja	Precio € m/pc
6																	
7,4	<b>1090032032</b>	<b>32</b>	<b>16</b>	40,00	22,00	43,00	29,00	16,00	29,50	57,00	36,00	245,00	0,141	•	1	100	<b>13,54</b>
9																	
11	<b>1090032033</b>	<b>32</b>	<b>20</b>	40,00	22,00	43,00	29,00	14,50	29,50	57,00	36,00	245,00	0,134	• • •	1	100	<b>13,54</b>

El colector de cuatro salidas puede acortarse o alargarse mediante la fusión de más colectores de cuatro salidas, si así se requiere.

**Aviso:** los accesorios metálicos aquatherm green pipe son fabricados con PP-R fusiolen y latón. También están disponibles en acero inoxidable para 1/2" y 3/4" sin cuello hexagonal. N° E53108 bajo demanda

**MANGUITO PUSH-FIT**

- Sistemas:** aquatherm blue pipe  
**Material:** fusiolen® PP-RCT/EPDM  
**Series:** SDR 11/17.6  
**Normativa:** UNE EN ISO 15874  
**Color:** verde  
**Nota:** no utilizar con aquatherm blue pipe MF RP OT

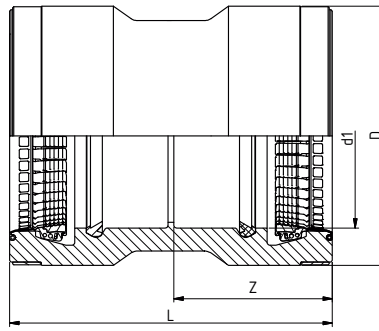

SDR	Art. nº.	d1 [mm]	L [mm]	D [mm]	z [mm]	Peso [kg]	Sistema	PU	Unidades caja	Precio € ud.
11 17.6	2054090020	90	285,0	152,0	140,0	2,300	•	1		573,91
	2054110021	110	345,0	175,0	170,0	3,700	•	1		711,14
	2054125022	125	350,0	190,0	172,0	4,300	•	1		810,95
	2054160023	160	372,0	234,0	183,0	6,600	•	1		998,10
	2054200024	200	470,0	285,0	231,0	11,000	•	1		1.441,00
	2054250025	250	496,0	375,0	243,0	24,200	•	1		4.379,15
	2054315026	315	560,0	450,0	275,0	40,200	•	1		6.437,72
	2054355027	355	576,0	492,0	283,0	45,700	•	1		9.151,29
	2054400028	400	610,0	540,0	300,0	54,800	•	1		9.949,77
2054450029	450	646,0	600,0	318,0	69,600	•	1		13.474,30	

**ADAPTADOR PUSH-FIT**

- Sistemas:** aquatherm blue pipe  
**Material:** fusiolen® PP-RCT/EPDM  
**Series:** SDR 11/17.6  
**Normativa:** UNE EN ISO 15874  
**Color:** verde  
**Nota:** no utilizar con aquatherm blue pipe MF RP OT

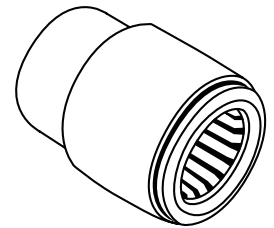
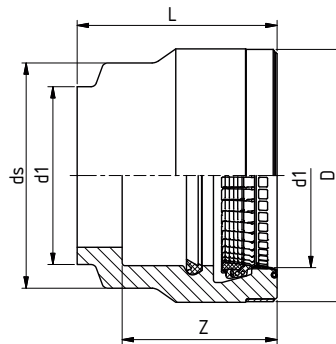

SDR	Art. nº.	d1 [mm]	L [mm]	D [mm]	ds [mm]	z [mm]	Peso [kg]	Sistema	PU	Unidades caja	Precio € ud.
11	2054090000	90	170,0	152,0	112,0	140,0	1,200	•	1		364,46
	2054110001	110	205,0	175,0	140,0	170,0	2,000	•	1		441,84
	2054125002	125	210,0	190,0	161,0	172,0	2,300	•	1		500,88
	2054160004	160	227,0	234,0	202,0	183,0	3,800	•	1		577,09
	2054200006	200	285,0	285,0	250,0	231,0	6,500	•	1		870,69
	2054250008	250	315,0	375,0	317,0	243,0	15,000	•	1		2.850,00
	2054315010	315	355,0	450,0	400,0	275,0	24,000	•	1		3.869,08
	2054355012	355	370,0	492,0	450,0	283,0	28,000	•	1		4.890,44
	2054400014	400	390,0	540,0	500,0	300,0	34,000	•	1		5.823,75
2054450016	450	415,0	600,0	560,0	318,0	44,000	•	1		7.427,09	
17.6	2057125003	125	210,0	190,0	161,0	172,0	2,300	•	1		500,88
	2057160005	160	227,0	234,0	202,0	183,0	3,800	•	1		577,09
	2057200007	200	285,0	285,0	250,0	231,0	6,500	•	1		870,69
	2057250009	250	315,0	355,0	295,0	243,0	11,500	•	1		2.850,00
	2057315011	315	345,0	425,0	370,0	275,0	16,300	•	1		3.869,08
	2057355013	355	360,0	470,0	415,0	283,0	20,000	•	1		4.890,44
	2057400015	400	390,0	510,0	465,0	300,0	23,800	•	1		5.823,75
2057450017	450	400,0	565,0	520,0	318,0	27,800	•	1		7.427,09	

Accesorios y conexiones, por ejemplo codos (90°/45°), tes, etc. bajo demanda.



## aquatherm: prefabricados y colectores

**Diseño y fabricación de colectores y pre-fabricados especiales en PP-R / PP-RP**

para redes agua sanitaria, fría y caliente  
aire acondicionado, calefacción y diversas aplicaciones industriales

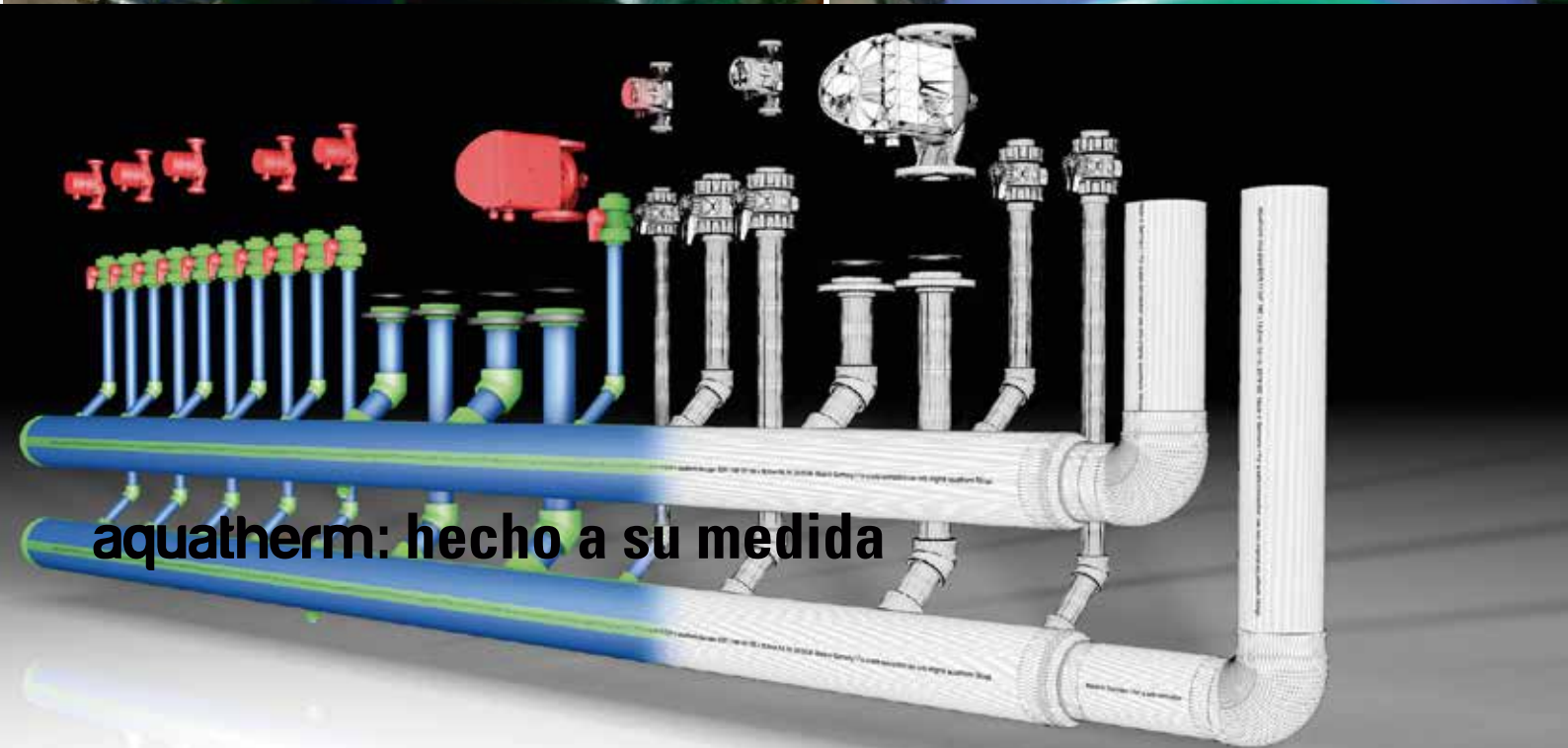

## aquatherm: hecho a su medida

### aquatherm green / blue / red PIEZAS ESPECIALES

Puede solicitar la elaboración de piezas especiales que necesite para completar la ejecución y que no se encuentren en nuestro amplio catálogo de accesorios.

Se le remitirá precio de la pieza solicitada así como el diseño de la misma para que pueda valorar su solicitud bajo una vista realista de la pieza que se le entregará.

### aquatherm green pipe BATERÍAS DE CONTADORES

Puede solicitar precio de baterías de contadores sin compromiso. Las baterías de contadores de aquatherm se fabrican bajo las indicaciones de la norma UNE 53943.

Disponemos de baterías de contadores tipo bandera, bandera con entrada superior, bandera con entrada lateral, doble entrada y entrada central. distribución de contadores hasta en tres filas y un máximo de 45 contadores por unidad de batería.

Las baterías de contadores se entregan marcadas con un número de serie, tipo de tubería con la que se han fabricado y fecha de fabricación.

## COLECTORES

### ESTRIBO, SOPORTE GALVANIZADO

con abrazaderas, galvanizado, doble

Sistemas: **aquatherm green pipe**, **aquatherm blue pipe**

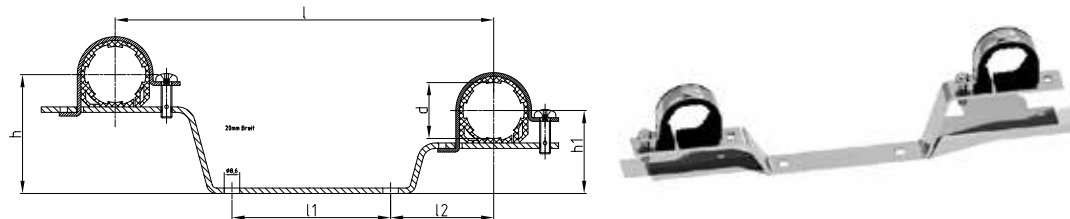

Art.-No.	d	l	l1	l2	h	h1	Peso [kg]	Sistemas	Uds./ Paquete	Uds./Caja	Precio € m/pc
9600060210	32	210,00	80,00	57,00	66,00	46,00	0,226	• • •	2		21,63

### ENTRONQUE RECTO PARA ACOPLAR EN COLECTOR\*

Sistemas: **aquatherm green pipe**, **aquatherm blue pipe**

Material: Fusiolen® PP-R, latón

Normas: DIN 16962, UNE EN ISO 15874

Color: verde

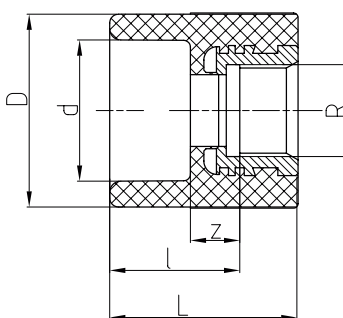

SDR	Art.-No.	d	R	l	z	D	L	Peso [kg]	Sistemas	Uds./ Paquete	Uds./Caja	Precio € m/pc
6												
7,4												
9	1090032034	32	1/2"	30,00	12,00	43,00	43,00	0,077	• • •	2	200	9,92
11												

\* elemento de transición como final de colector, con rosca hembra.

**Aviso:** los accesorios metálicos aquatherm green pipe son fabricados con PP-R fusiolen y latón. También están disponibles en acero inoxidable para 1/2" y 3/4" sin cuello hexagonal. N° E53180 bajo pedido.

### CUERPO DE VÁLVULA DE ASIENTO RECTO

Sistemas: **aquatherm green pipe**, **aquatherm blue pipe**

Material: Fusiolen® PP-R, latón

Color: verde

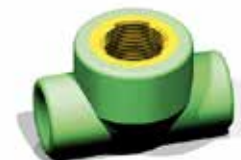
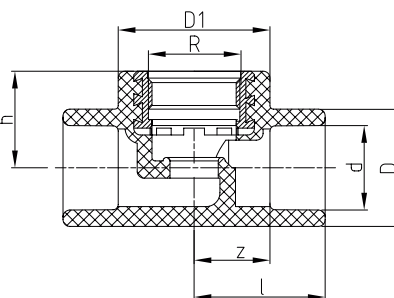

SDR	Art.-No.	d	R	l	z	D	h	D1	Peso [kg]	Sistemas	Uds./ Paquete	Uds./Caja	Precio € m/pc
6													
7,4													
9	1090020046	20	3/4"	35,00	20,00	29,50	28,00	44,00	0,093	• • •	1	150	8,17
	1090025047	25	3/4"	38,00	22,00	34,00	28,00	44,00	0,101	• • •	1	150	8,17
	1090032048	32	1"	49,00	31,00	43,00	34,00	52,00	0,146	• • •	1	100	15,59
11	1090040049	40	1 1/4"	60,00	39,50	52,00	41,00		0,313	• • •	1	50	28,82



**VÁLVULA DE ASIENTO - CUELLO CORTO**

para montaje empotrado, cromada, con regulación oculta

Sistemas: **aquatherm green pipe**, **aquatherm blue pipe**

Material: Fusiolen® PP-R, latón

Color: verde, cromado

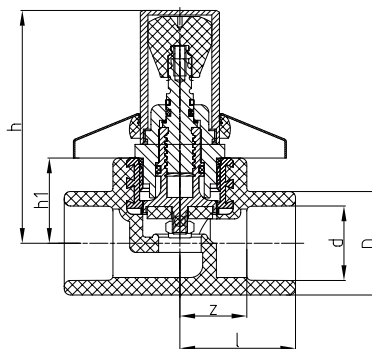

SDR	Art.-No.	d	l	z	D	h	h1	Peso [kg]	Sistemas	Uds./Paquete	Uds./Caja	Precio € m/pc
6												
7,4	<b>1050020153</b>	<b>20</b>	35,00	20,50	29,50	71,50	28,00	0,258	• • •	1	50	<b>37,12</b>
9	<b>1050025154</b>	<b>25</b>	38,00	22,00	34,00	71,50	28,00	0,288	• • •	1	50	<b>38,43</b>
11	<b>1050032155</b>	<b>32</b>	49,00	31,00	43,00	82,50	34,00	0,376	• • •	1	30	<b>58,01</b>

**VÁLVULA DE ASIENTO - CUELLO CORTO**

para montaje empotrado, cromada, con regulación oculta, unicap (S.H.)

Sistemas: **aquatherm green pipe**, **aquatherm blue pipe**

Material: Fusiolen® PP-R, latón

Color: verde, cromado

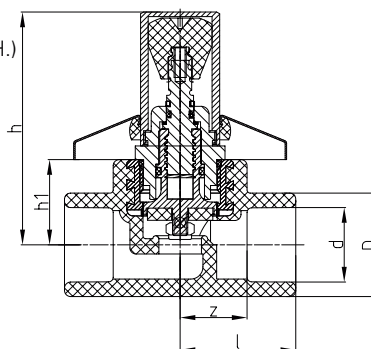

SDR	Art.-No.	d	l	z	D	h	h1	Peso [kg]	Sistemas	Uds./Paquete	Uds./Caja	Precio € m/pc
6												
7,4	<b>40889</b>	<b>20</b>	35,00	20,50	29,50	71,50	28,00	0,258	• • •	1	50	<b>27,32</b>
9	<b>40891</b>	<b>25</b>	38,00	22,00	34,00	71,50	28,00	0,288	• • •	1	50	<b>27,32</b>

**VÁLVULA DE ASIENTO RECTO**

cromada, para instalación empotrada

Sistemas: **aquatherm green pipe**, **aquatherm blue pipe**

Material: Fusiolen® PP-R, latón

Color: verde, cromado

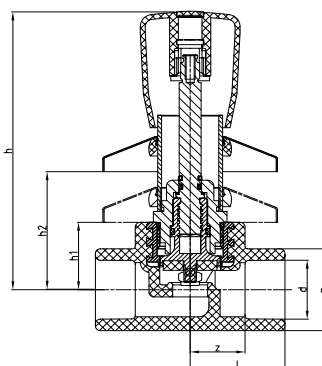

SDR	Art.-No.	d	l	z	D	h	h1	h2	Peso [kg]	Sistemas	Uds./Paquete	Uds./Caja	Precio € m/pc
6													
7,4	<b>1050020150</b>	<b>20</b>	35,00	20,50	29,50	116,00	28,00	59,00	0,319	• • •	1	40	<b>52,03</b>
9	<b>1050025151</b>	<b>25</b>	38,00	22,00	34,00	116,00	28,00	59,00	0,330	• • •	1	40	<b>52,03</b>
11	<b>1050032152</b>	<b>32</b>	49,00	31,00	43,00	121,00	34,00	59,00	0,416	• • •	1	30	<b>87,77</b>

**VÁLVULA DE ASIENTO RECTO**

cromada, para instalación empotrada, unicap (S.H.)

Sistemas: **aquatherm green pipe**, **aquatherm blue pipe**

Material: Fusiolen® PP-R, latón

Color: verde, cromado

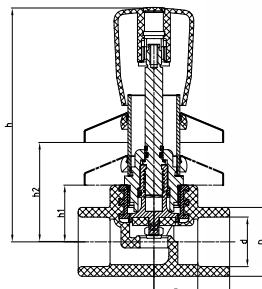

SDR	Art.-No.	d	l	z	D	h	h1	h2	Peso [kg]	Sistemas	Uds./Paquete	Uds./Caja	Precio € m/pc
6													
7,4	<b>40859</b>	<b>20</b>	35,00	20,50	29,50	116,00	28,00	59,00	0,319	• • •	1	40	<b>31,00</b>
9													
11	<b>40861</b>	<b>25</b>	38,00	22,00	34,00	116,00	28,00	59,00	0,330	• • •	1	40	<b>31,00</b>

**VÁLVULA DE ASIENTO - CUELLO LARGO**

para montaje empotrado. Profundidad de 55mm hasta 100 mm

Sistemas: **aquatherm green pipe**, **aquatherm blue pipe**

Material: Fusiolen® PP-R, latón

Color: verde, cromado

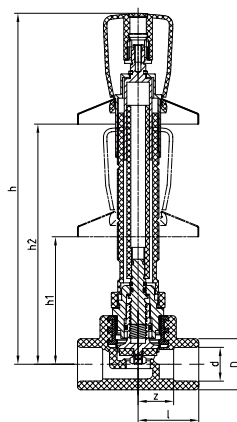

SDR	Art.-No.	d	l	z	D	h	h1	h2	Peso [kg]	Sistemas	Uds./Paquete	Uds./Caja	Precio € m/pc
6													
7,4	<b>1050020156</b>	<b>20</b>	35,00	20,50	29,50	213,00	59,00	147,00	0,357	• • •	1	40	<b>62,07</b>
9	<b>1050025157</b>	<b>25</b>	38,00	22,00	34,00	213,00	59,00	147,00	0,369	• • •	1	40	<b>62,07</b>
11	<b>1050032158</b>	<b>32</b>	49,00	31,00	43,00	219,00	65,00	153,00	0,455	• • •	1	20	<b>91,70</b>

**VÁLVULA DE ASIENTO - CUELLO LARGO**

para montaje empotrado, cromada, con regulación oculta.

Sistemas: **aquatherm green pipe**, **aquatherm blue pipe**

Material: Fusiolen® PP-R, latón

Color: verde, cromado

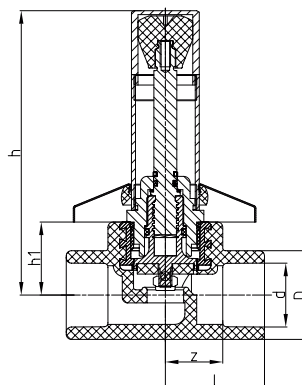

SDR	Art.-No.	d	l	z	D	h	h1	Peso [kg]	Sistemas	Uds./Paquete	Uds./Caja	Precio € m/pc
6												
7,4	<b>1050020159</b>	<b>20</b>	35,00	20,50	29,50	109,00	28,00	0,342	• • •	1	50	<b>49,28</b>
9	<b>1050025160</b>	<b>25</b>	38,00	22,00	34,00	109,00	28,00	0,350	• • •	1	50	<b>49,28</b>
11	<b>1050032161</b>	<b>32</b>	49,00	31,00	43,00	115,00	34,00	0,432	• • •	1	40	<b>78,29</b>

**ALARGADERA PARA VÁLVULA EMPOTRADA**

cromada, para Art.-No. 40858-40862

Sistemas: **aquatherm green pipe**, **aquatherm blue pipe**

Material: latón

Color: cromado

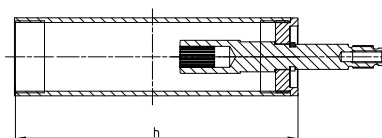

Art.-No.	h	Peso [kg]	Sistemas	Uds./ Paquete	Uds./Caja	Precio € m/pc
<b>9600040900</b>	92,00	0,148	• • •	1	200	<b>21,90</b>
<b>9600040902</b>	132,00	0,209	• • •	1	200	<b>29,82</b>

**VÁLVULA DE ASIENTO RECTO**

para instalación en superficie.

Sistemas: **aquatherm green pipe**, **aquatherm blue pipe**

Material: Fusiolen® PP-R, latón

Color: verde

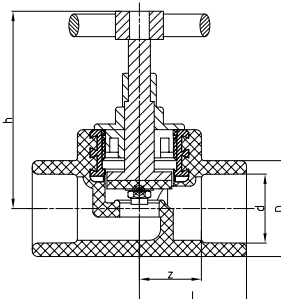

SDR	Art.-No.	d	l	z	D	h	Peso [kg]	Sistemas	Uds./ Paquete	Uds./Caja	Precio € m/pc
6 7,4 9 11	<b>1090020040</b>	<b>20</b>	35,00	20,50	29,50	70,00	0,165	• • •	1	100	<b>15,03</b>
	<b>1090025041</b>	<b>25</b>	38,00	22,00	34,00	70,00	0,172	• • •	1	100	<b>16,00</b>
	<b>1090032042</b>	<b>32</b>	49,00	31,00	43,00	86,50	0,314	• • •	1	60	<b>33,50</b>
	<b>1090040043</b>	<b>40</b>	60,00	39,50	52,00	100,50	0,585	• • •	1	35	<b>48,53</b>

**VÁLVULA DE ASIENTO OBLÍCUO**

paso libre

Sistemas: **aquatherm green pipe**, **aquatherm blue pipe**

Material: Fusiolen® PP-R, latón

Color: verde

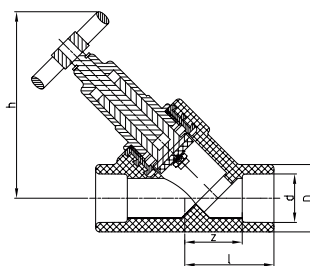

SDR	Art.-No.	d	l	z	D	h	Peso [kg]	Sistemas	Uds./ Paquete	Uds./Caja	Precio € m/pc
6 7,4 9 11	<b>1050020162</b>	<b>20</b>	45,00	30,50	34,00	95,50	0,294	• • •	1	100	<b>46,35</b>
	<b>1050025163</b>	<b>25</b>	45,00	29,00	34,00	95,50	0,283	• • •	1	80	<b>46,35</b>
	<b>1050032164</b>	<b>32</b>	56,00	38,00	43,00	111,50	0,421	• • •	1	50	<b>58,20</b>
	<b>1050040165</b>	<b>40</b>	65,00	44,50	52,00	135,00	0,834	• • •	1	25	<b>87,77</b>

**VÁLVULA DE ASIENTO OBLÍCUO CON ANTI-RETORNO**

paso libre

Sistemas: **aquatherm green pipe**, **aquatherm blue pipe**

Material: Fusiolen® PP-R, latón

Color: verde

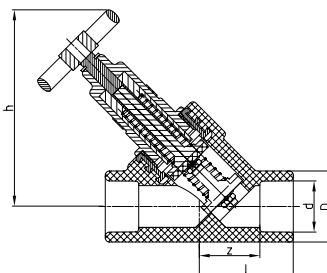

SDR	Art.-No.	d	l	z	D	h	Peso [kg]	Sistemas	Uds./ Paquete	Uds./Caja	Precio € m/pc
6 7,4 9 11	<b>1050020170</b>	<b>20</b>	45,00	30,50	34,00	95,50	0,297	• • •	1	80	<b>54,59</b>
	<b>1050025171</b>	<b>25</b>	45,00	29,00	34,00	95,50	0,292	• • •	1	80	<b>54,59</b>
	<b>1050032172</b>	<b>32</b>	56,00	38,00	43,00	111,50	0,432	• • •	1	50	<b>65,62</b>
	<b>1050040173</b>	<b>40</b>	65,00	44,50	52,00	135,00	0,840	• • •	1	25	<b>123,95</b>

**VÁLVULA DE ESFERA - CON CIERRE DE LATÓN**

Sistemas: **aquatherm green pipe**, **aquatherm blue pipe**  
 Material: Fusiolen® PP-R, latón  
 Color: verde

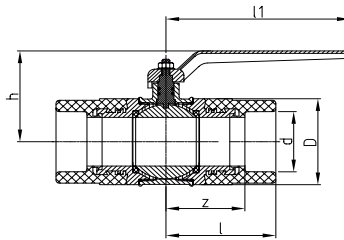

SDR	Art.-No.	d	l	z	D	h	l1	Peso [kg]	Sistemas	Uds./ Paquete	Uds./Caja	Precio € m/pc
6 7,4 9 11	<b>1050020174</b>	<b>20</b>	55,00	40,50	32,00	66,00	85,00	0,280	• • •	1	100	<b>40,67</b>
	<b>1050025175</b>	<b>25</b>	55,00	39,00	41,00	73,00	85,00	0,375	• • •	1	100	<b>46,54</b>
	<b>1050032176</b>	<b>32</b>	63,50	45,50	47,00	82,00	108,00	0,592	• • •	1	60	<b>62,51</b>
	<b>1050040177</b>	<b>40</b>	72,50	52,00	58,00	93,00	108,00	1,034	• • •	1	40	<b>106,80</b>
	<b>1050050178</b>	<b>50</b>	83,50	60,00	70,50	114,00	140,00	1,339	• • •	1	25	<b>153,33</b>
	<b>1050063179</b>	<b>63</b>	102,50	75,00	87,00	132,00	140,00	2,552	• • •	1	15	<b>246,40</b>

**VÁLVULA DE ESFERA - CON CIERRE DE LATÓN**

hembra/macho

Sistemas: **aquatherm green pipe**, **aquatherm blue pipe**  
 Material: Fusiolen® PP-R, latón  
 Color: verde

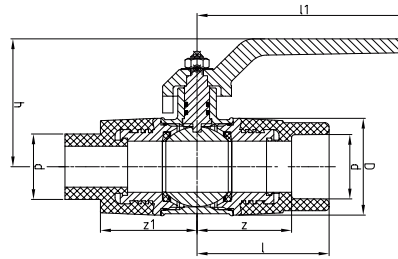

SDR	Art.-No.	d	l	z	D	z1	h	l1	Peso [kg]	Sistemas	Uds./ Paquete	Uds./Caja	Precio € m/pc
6 7,4 9 11	<b>1050032189</b>	<b>32</b>	63,00	45,00	47,50	46,50	78,00	108,00	0,575	• • •	2	50	<b>56,08</b>

**ALARGADERA PARA VÁLVULA DE ESFERA**

cromada, para Art.-No. 41308-41318

Sistemas: **aquatherm green pipe**, **aquatherm blue pipe**  
 Material: latón  
 Color: bronce

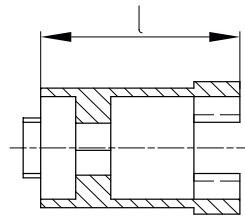

Art.-No.	l	for Art.-No.	Peso [kg]	Sistemas	Uds./ Paquete	Uds./Caja	Precio € m/pc
<b>1050000180</b>	<b>35,00</b>	<b>41308 / 41310</b>	0,120	• • •	1	100	<b>26,51</b>
<b>1050000181</b>	<b>35,00</b>	<b>41312 / 41314</b>	0,120	• • •	1	100	<b>26,51</b>
<b>1050000182</b>	<b>46,00</b>	<b>41316 / 41318</b>	0,273	• • •	1	75	<b>30,32</b>

**VÁLVULA DE ESFERA - DE PPR**

unión desmontable y soldadura a enchufe

Sistemas: **aquatherm green pipe**, **aquatherm blue pipe**  
 Material: Fusiolen® PP-R  
 Color: verde

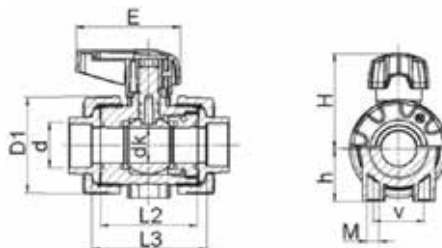

SDR	Art.-No.	d	dk	D1	E	h	H	L2	L3	DN	Peso [kg]	Sistemas	Uds./ Paquete	Uds./Caja	Precio € m/pc
6 7,4 9 11	<b>1090020052</b>	<b>20</b>	13,5	50,30	66	27,00	48	56,50	68,00	15	0,118	• • •	1	200	<b>65,69</b>
	<b>1090025053</b>	<b>25</b>	18,5	59,00	81	30,00	56,5	65,50	78,50	20	0,188	• • •	1	120	<b>70,24</b>
	<b>1090032054</b>	<b>32</b>	23,9	70,30	81,5	40,00	64,5	72,00	84,50	25	0,277	• • •	1	80	<b>81,84</b>
	<b>1090040055</b>	<b>40</b>	31,0	85,90	91,5	46,00	83,3	85,00	100,00	32	0,434	• • •	1	55	<b>103,61</b>
	<b>1090050056</b>	<b>50</b>	38,5	99,50	91,5	55,00	89,4	89,00	107,00	40	0,549	• • •	1	45	<b>135,74</b>
	<b>1090063057</b>	<b>63</b>	50,0	125,50	141,5	70,00	115	101,00	118,00	50	0,922	• • •	1	25	<b>165,43</b>

**VÁLVULA DE ESFERA - DE PPR**

unión desmontable y soldadura a enchufe

Sistemas: **aquatherm green pipe, aquatherm blue pipe**

Material: Fusiolen® PP-R

Color: verde

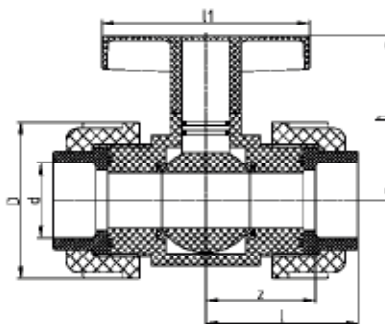

SDR	Art.-No.	d	l	z	D	h	l1	Giro R	DN	Peso [kg]	Sistemas	Uds./Paquete	Uds./Caja	Precio € m/pc
6														
7,4														
9	<b>1090075051</b>	<b>75</b>	138,00	108,00	129,00	137,00	186,00		65	2,615	• • •	1	10	<b>479,46</b>
11														

**VÁLVULA DE ESFERA - DE PPR**

bridas de conexión internas en ambas caras incluidas

Sistemas: **aquatherm green pipe, aquatherm blue pipe**

Material: Fusiolen® PP-R

Color: verde

Nota: Se requiere de dos cuellos y dos bridas para su completa instalación (no incluidos)

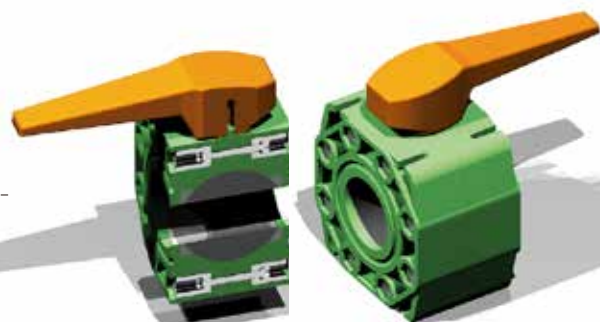
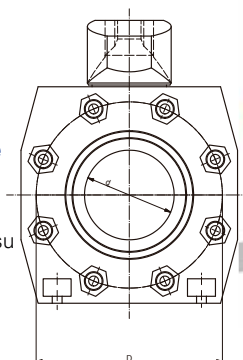

SDR	Art.-No.	for ø	d	l	z	D	h1	h2	DN	Peso [kg]	Sistemas	Uds./Paquete	Uds./Caja	Precio € m/pc
6														
7,4	<b>1090090058</b>	<b>90</b>	77	210,00	124,00	160,00	150,00	93,00	80	4,171	• • •	1	4	<b>717,44</b>
9	<b>1090110059</b>	<b>110/125</b>	94	260,00	145,00	180,00	165,00	103,00	100	5,612	• • •	1	2	<b>776,14</b>
11	<b>1090160060</b>	<b>160</b>	135	310,00	205,00	240,00	210,00	136,50	150	5,615	• • •	1	1	<b>1.421,78</b>

Para dimensión 125 mm se utiliza la válvula Art.-No. 41604 con portabridas Art.-No. 15526 y brida Art.-No. 15724.

Tornillo hexagonal M16x60mm para Art.-No. 41602/41604

Tornillo hexagonal M16x80mm para Art.-No. 41607

Para M16 utilizar arandela plana

AVISO: No incluidos.

**VÁLVULA DE VACIADO**

Para acoplar en válvulas de aquatherm green pipe

Sistemas: **aquatherm green pipe, aquatherm blue pipe**

Material: Fusiolen® PP-R, latón

Color: verde

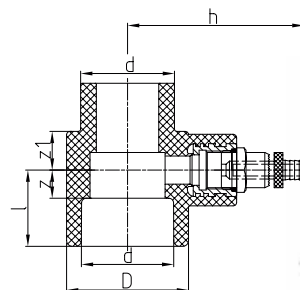
detalle de montaje.  
art. 41410  
art. 41110

SDR	Art.-No.	d	z	l	D	z1	h	Peso [kg]	Sistemas	Uds./Paquete	Uds./Caja	Precio € m/pc
6	<b>1050020183</b>	<b>20</b>	11,50	26,00	34,00	16,50	67,00	0,098	• • •	1	200	<b>15,28</b>
7,4	<b>1050025184</b>	<b>25</b>	10,00	26,00	34,00	16,50	67,00	0,096	• • •	1	200	<b>15,28</b>
9	<b>1050032185</b>	<b>32</b>	14,00	32,00	43,00	17,00	70,50	0,118	• • •	1	150	<b>16,91</b>
11	<b>1050040186</b>	<b>40</b>	12,00	32,50	52,00	16,50	76,50	0,140	• • •	1	100	<b>16,91</b>
	<b>1050050187</b>	<b>50</b>	15,50	39,00	68,00	17,00	83,75	0,202	• • •	1	40	<b>20,21</b>
	<b>1050063188</b>	<b>63</b>	16,50	44,00	84,00	16,50	93,00	0,288	• • •	1	25	<b>23,14</b>

**EXTENSIÓN PARA VÁLVULA DE BOLA DE PP-R SOLDADA**

Para Art.-No. 41488-41498

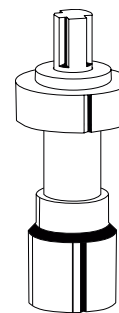
**Sistemas:** aquatherm green pipe,  
aquatherm blue pipe,**Material:** PVC**Color:** gris

Art.-No.	l	Para Art.-No.	Peso [kg]	Sistema	Uds./Paquete	Uds./Caja	Precio € m/pc
9700098900	100	41488	0,020	• • •	1		163,06
9700098901	100	41490/41492	0,025	• • •	1		169,61
9700098902	100	41494/41496	0,030	• • •	1		176,10
9700098903	100	41498	0,040	• • •	1		189,14

Plazo de entrega: Bajo demanda

**aquatherm blue pipe VÁLVULA DE MARIPOSA DE PALANCA**

Incluye: 2 x cuellos portabridas, 2 x bridas, tornillos de fijación

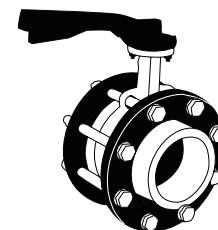
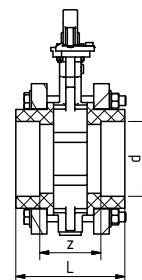
**Sistemas:** aquatherm blue pipe**Material:** Fusiolen® PP-R, Acero

SDR	Art.-No.	d	z	L	Peso [kg]	Sistema	Uds./Paquete	Uds./Caja	Precio € m/pc
<i>Soldadura a enchufe</i>									
6	9702041820	75	78	138	6,600	•	1		343,59
7,4	9702041822	90	80	146	9,000	•	1		426,31
9	9702041824	110	89	163	10,400	•	1		515,39
11	9702041826	125	104	184	15,000	•	1		687,19
17,6									

**aquatherm blue pipe VÁLVULA DE MARIPOSA DE PALANCA**

Incluye: 2 x cuellos portabridas, 2 x bridas, tornillos de fijación

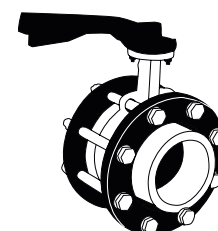
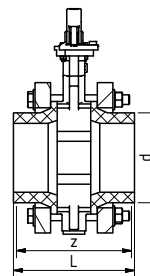
**Sistemas:** aquatherm blue pipe**Material:** Fusiolen® PP-R, Acero

SDR	Art.-No.	d	z	L	Peso [kg]	Sistema	Uds./Paquete	Uds./Caja	Precio € m/pc
<i>Soldadura a tope</i>									
11	9702041830	160	227	242	22,000	•	1		941,70
17,6	9702541830	160	227	242	21,700	•	1		909,89

**NUEVO aquatherm blue pipe VÁLVULA DE MARIPOSA DE VOLANTE**

Incluye: 2 x cuellos portabridas, 2 x bridas, tornillos de fijación

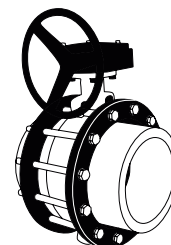
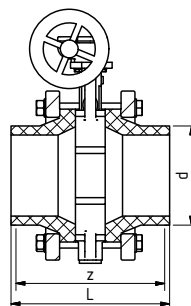
**Sistemas:** aquatherm blue pipe**Material:** Fusiolen® PP-R, Acero

SDR	Art.-No.	d	z	L	Peso [kg]	Sistema	Uds./Paquete	Uds./Caja	Precio € m/pc
11	9702041834	200	305	320	41,400	•	1		1.368,02
	9702041838	250	313	328	59,200	•	1		2.125,20
	9702041842	315	398	418	81,800	•	1		4.371,29
17,6	9702541834	200	305	320	40,900	•	1		1.387,10
	9702541838	250	313	328	58,400	•	1		1.877,04
	9702541842	315	398	418	78,600	•	1		3.951,34

**NUEVO aquatherm blue pipe VÁLVULA ANTI-RETORNO**

Incluye: 2 x cuellos portabridas, 2 x bridas, tornillos de fijación

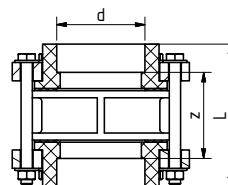
**Sistemas:** aquatherm blue pipe**Material:** Fusiolen® PP-R, Acero

SDR	Art.-No.	d	z	L	Peso [kg]	Sistema	Uds./Paquete	Uds./Caja	Precio € m/pc
<i>Soldadura a enchufe</i>									
6	2041920	75	92	152	6,200	•	1		344,90
7,4	2041922	90	97	163	8,800	•	1		463,24
9	2041924	110	107	181	11,000	•	1		606,55
11	2041926	125	124	204	15,600	•	1		802,79
17,6									

**NUEVO aquatherm blue pipe VÁLVULA ANTI-RETORNO**

Incluye: 2 x cuellos portabridas, 2 x bridas, tornillos de fijación

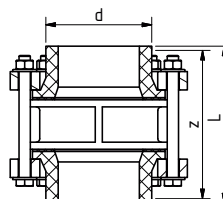
**Sistemas:** aquatherm blue pipe**Material:** Fusiolen® PP-R, Acero

SDR	Art.-No.	d	z	L	Peso [kg]	Sistema	Uds./Paquete	Uds./Caja	Precio € m/pc
<i>Soldadura a tope</i>									
11	2041930	160	253	268	24,200	•	1		1.117,96
	2041934	200	352	367	37,000	•	1		1.587,74
	2041938	250	365	380	58,600	•	1		2.432,16
	2041942	315	476	496	83,400	•	1		3.877,18
17,6	2541930	160	253	268	23,900	•	1		1.106,07
	2541934	200	352	367	36,500	•	1		1.599,64
	2541938	250	365	380	57,800	•	1		2.438,11
	2541942	315	476	496	80,200	•	1		3.787,98



# DISTRICT HEATING & COOLING



## Ventajas de las redes de distribución de energía.

- La producción no se realiza de manera local.
- La contaminación se desplaza fuera de los núcleos urbanos.
- Producción y distribución más eficiente de la energía.
- Carencia de mantenimientos en los puntos de consumo.
- Menor requerimiento de espacio en la zona técnica de viviendas.

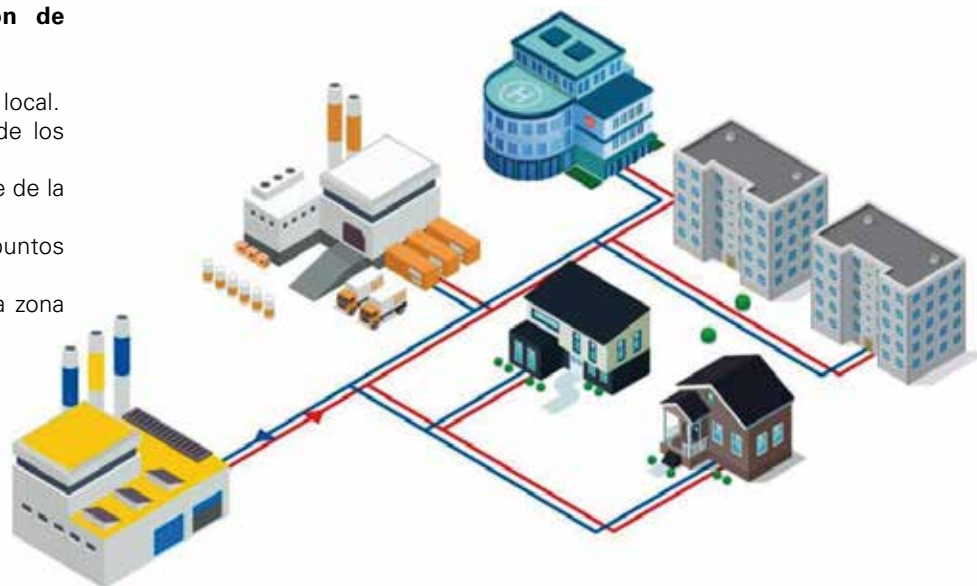



# aquatherm ti

## SISTEMA DE TUBERÍA PRE-AISLADA PARA DISTRICT HEATING AND COOLING

Uno de los sistemas de mayor eficiencia energética en el transporte de agua caliente y refrigerada para grandes distancias es el uso de las tuberías enterradas. Para lograr las necesidades de aislamiento térmico de este tipo de aplicaciones, aquatherm ofrece tuberías pre-aisladas de fábrica con diferentes tipos de tubería.

- **aquatherm green pipe ti -**  
Tubería compuesta con fibra Serie 3,2/ SDR 7,4  
Sistema de tuberías para agua potable  
Dimensiones DN32 – DN355
- **aquatherm blue pipe ti -**  
Tubería compuesta con fibra Serie 5/ SDR 11  
Sistema de tuberías para calefacción, agua refrigerada y aguas residuales  
Dimensiones DN32 – DN355
- **aquatherm blue pipe ot ti -**  
Tubería compuesta con fibra Serie 5/ SDR 11  
Con barrera antidifusora de oxígeno, para calefacción, agua refrigerada y aplicaciones industriales  
Dimensiones DN32 – DN250

El aislamiento de estas tuberías está realizado con espuma de poliuretano rígida (PUR), recubierto con una capa de polietileno de alta densidad PEHD.

Todos los sistemas de tuberías Aquatherm-TI son tuberías compuestas de fibra y son también las más apropiadas para las siguientes aplicaciones:

Para información adicional por favor llamen a nuestra asistencia técnica 91 380 66 08 o visite [www.aquatherm.es](http://www.aquatherm.es)

### CAMPOS DE APLICACIÓN

Sistema recomendado debido a sus ventajas técnicas: ●  
La aplicación del sistema resulta adecuada: ○

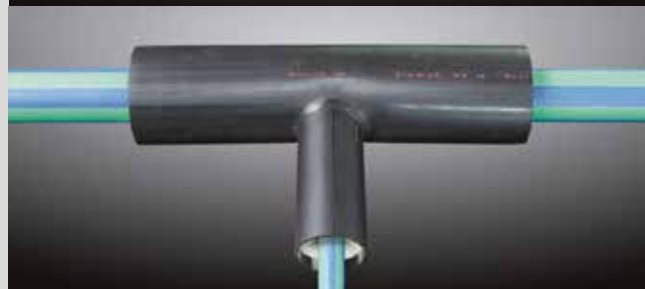
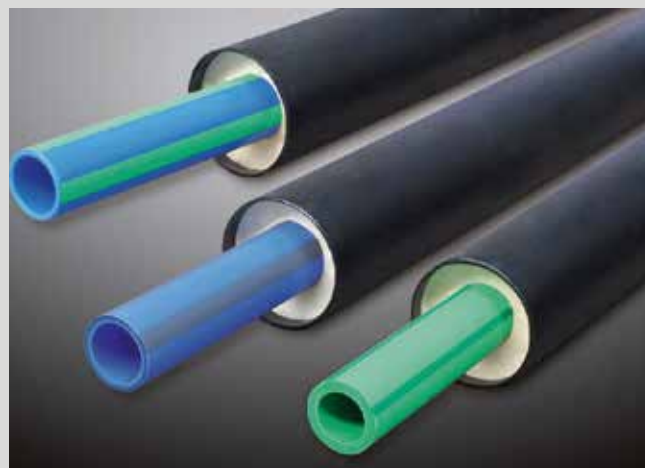

aquatherm green pipe ti

aquatherm blue pipe ti

aquatherm blue pipe ot ti

	aquatherm green pipe ti	aquatherm blue pipe ti	aquatherm blue pipe ot ti
Agua potable	●		
Calefacción	○	●	●
Climatización	○	●	●
Agua refrigerada	○	●	●
Piscinas	●	●	
Agua de lluvia	●	●	
Riego	●	●	
Aire comprimido	○	●	
Geotermia	○	●	○
Transporte de productos químicos (Considerando la compatibilidad química)	●	●	●

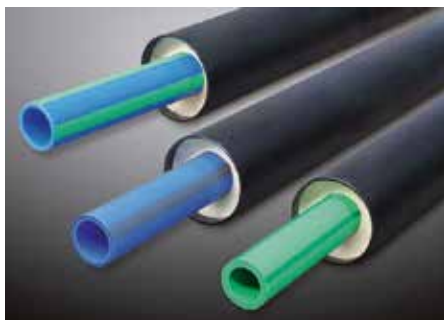

**aquatherm ti - TUBERÍAS COMPUESTAS CON FIBRA (FASER)**

tubería compuesta faser , longitud de 5,8 m con espuma rígida PUR y protegida con revestimiento de PEHD

Diámetro exterior		Sistema								ml./Paquete	ml./Caja
Diámetro nominal	Revestimiento	aquatherm green pipe ti SDR 9		aquatherm blue pipe ti SDR 11		aquatherm blue pipe ot ti SDR 11		aquatherm blue pipe ti SDR 17,6		m/pc	
		Art.-No.	Precio € m/pc	Art.-No.	Precio € m/pc	Art.-No.	Precio € m/pc	Art.-No.	Precio € m/pc		
32 mm	90 mm	1313032010	83,09	2314032010	80,00	2414032010	78,60			5,8	10
40 mm	110 mm	1313040012	87,21	2314040012	87,00	2414040012	85,59			5,8	10
50 mm	110 mm	1313050014	95,57	2314050014	89,68	2414050014	92,45			5,8	10
63 mm	125 mm	1313063016	106,80	2314063016	98,08	2414063016	103,43			5,8	10
75 mm	140 mm	1313075018	123,64	2314075018	111,84	2414075018	118,65			5,8	10
90 mm	160 mm	1313090020	146,72	2314090020	131,08	2414090020	137,74			5,8	10
110 mm	200 mm	1313110022	187,14	2314110022	161,39	2414110022	172,30			5,8	10
125 mm	225 mm	1313125024	226,32	2314125024	192,98	2414125024	208,23	2317125024	182,53	5,8	10
160 mm	250 mm	1313160026	300,68	2314160026	245,47	2414160026	276,47	2317160026	225,69	5,8	10
200 mm	315 mm	1313200028	434,42	2314200028	355,78	2414200028	420,70	2317200028	326,63	5,8	10
250 mm	400 mm	1313250030	685,82	2314250030	559,84	2414250030	664,73	2317250030	515,64	5,8	10
315 mm	450 mm	1313315032	980,38	2314315032	755,50			2317315032	696,05	5,8	10
355 mm	500 mm			2314355034	1.033,83			2317355034	1.011,82	5,8	10

Disponible bajo solicitud: aquatherm green pipe ti SDR7,4

**aquatherm ti - TUBERÍAS COMPUESTAS CON FIBRA (FASER)**

tubería compuesta faser , longitud de 11,6 m con espuma rígida PUR y protegida con revestimiento de PEHD

Diámetro exterior		Sistema								ml./Paquete	ml./Caja
Diámetro nominal	Revestimiento	aquatherm green pipe ti SDR 9		aquatherm blue pipe ti SDR 11		aquatherm blue pipe ot ti SDR 11		aquatherm blue pipe ti SDR 17,6		m/pc	
		Art.-No.	Precio € m/pc	Art.-No.	Precio € m/pc	Art.-No.	Precio € m/pc	Art.-No.	Precio € m/pc		
32 mm	90 mm	1313032110	78,23	2314032110	74,48	2414032110	77,23			11,6	10
40 mm	110 mm	1313040112	87,46	2314040112	79,97	2414040112	82,72			11,6	10
50 mm	110 mm	1313050114	90,83	2314050114	82,72	2414050114	85,59			11,6	10
63 mm	125 mm	1313063116	100,68	2314063116	92,45	2414063116	96,44			11,6	10
75 mm	140 mm	1313075118	117,78	2314075118	107,54	2414075118	111,79			11,6	10
90 mm	160 mm	1313090120	140,48	2314090120	125,51	2414090120	131,00			11,6	10
110 mm	200 mm	1313110122	181,65	2314110122	157,08	2414110122	165,43			11,6	10
125 mm	225 mm	1313125124	221,58	2314125124	190,26	2414125124	201,37	2317125124	175,66	11,6	10
160 mm	250 mm	1313160126	296,56	2314160126	242,79	2414160126	262,75	2317160126	215,09	11,6	10
200 mm	315 mm	1313200128	385,76	2314200128	353,08	2414200128	402,61	2317200128	311,66	11,6	10
250 mm	400 mm	1313250130	685,82	2314250130	561,05	2414250130	635,66	2317250130	495,18	11,6	10
315 mm	450 mm	1313315132	1.020,55	2314315132	688,56			2317315132	665,85	11,6	10
355 mm	500 mm			2314355134	966,28			2317355134	837,90	11,6	10

Disponible bajo solicitud: aquatherm green pipe ti SDR7,4

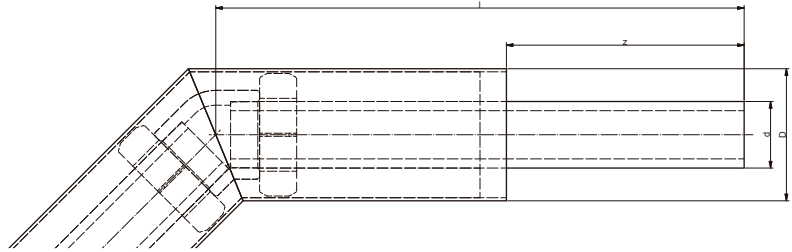

**aquatherm ti - CODO 45° SL 500**

con espuma rígida PUR y protegida con revestimiento de PEHD

Diámetro exterior				Sistema								Uds./Paquete	Uds./Caja
d Diámetro nominal	D Revestimiento	z	l	aquatherm green pipe ti SDR 9		aquatherm blue pipe ti SDR 11		aquatherm blue pipe ot ti SDR 11		aquatherm blue pipe ti SDR 17,6		m/pc	
				Art.-No.	Precio € m/pc	Art.-No.	Precio € m/pc	Art.-No.	Precio € m/pc	Art.-No.	Precio € m/pc		
32	90,00	225,00	500,00	1383032001	156,95	2384032060	150,09	2480032001	159,32			1	10
40	110,00	225,00	500,00	1383040002	182,78	2384110061	176,29	2480040002	182,78			1	10
50	110,00	225,00	500,00	1383050003	208,85	2384050062	182,78	2480050003	189,39			1	10
63	125,00	225,00	500,00	1383063004	241,54	2384063063	234,93	2480063004	248,03			1	10
75	140,00	225,00	500,00	1383075005	287,20	2384075064	274,23	2480075005	287,20			1	10
90	160,00	225,00	500,00	1383090006	326,38	2384090065	306,79	2480090006	319,89			1	10
110	200,00	225,00	500,00	1383110007	378,65	2384110066	352,58	2480110007	365,55			1	10
125	225,00	225,00	500,00	1383125008	463,49	2384125067	430,93	2480125008	450,52	2387125068	346,09	1	10
160	250,00	225,00	500,00	1383160009	613,70	2384160069	522,25	2484160009	548,33	2387160070	378,65	1	10
200	315,00	225,00	500,00	1383200010	881,32	2384200071	789,99	2484200010	626,68	2387200072	535,35	1	10
250	400,00	225,00	500,00	1383250011	1.142,45	2384250073	985,74	2484250011	874,83	2387250074	718,13	1	10
315	450,00	225,00	500,00	1383315012	1.371,01	2384315075	1.240,38			2387315076	1.024,92	1	10
355	500,00	225,00	500,00			2384355077	1.488,41			2387355078	1.259,97	1	10

También disponibles en diseños de 15° y 30°

Disponible bajo solicitud: aquatherm green pipe ti SDR7,4

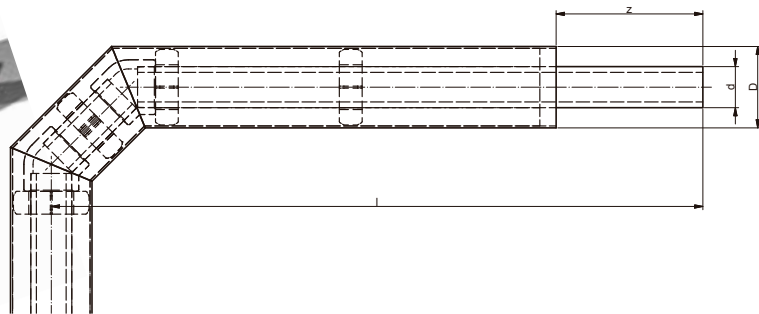

**aquatherm ti - CODO 90° SL 500**

con espuma rígida PUR y protegida con revestimiento de PEHD

Diámetro exterior				Sistema						Uds./Paquete	Uds./Caja
d Diámetro nominal	D Revestimiento	z	l	aquatherm green pipe ti SDR 9		aquatherm blue pipe ti SDR 11		aquatherm blue pipe ot ti SDR 11		m/pc	
				Art.-No.	Precio € m/pc	Art.-No.	Precio € m/pc	Art.-No.	Precio € m/pc		
32	90,00	225,00	500,00	1383032040	222,70	2384032081	220,08	2480032021	231,18	1	10
40	110,00	225,00	500,00	1383040041	265,12	2384040083	260,13	2480040023	272,60	1	10
50	110,00	225,00	500,00	1383050042	307,04	2384050085	303,42	2480050025	318,02	1	10
63	125,00	225,00	500,00	1383063043	353,33	2384063087	348,71	2480063027	365,55	1	10
75	140,00	225,00	500,00	1383075044	424,32	2384075089	417,70	2480075029	437,79	1	10

También disponibles en diseños de 60° y 75°

Disponible bajo solicitud: aquatherm green pipe ti SDR7,4

aquatherm ti pre-aislado

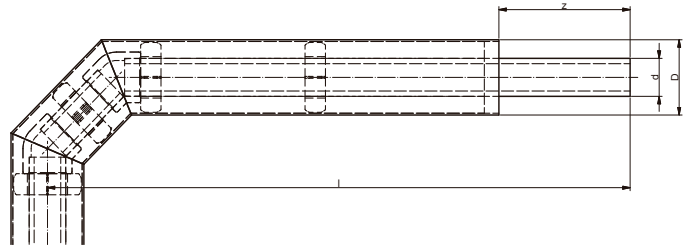

**aquatherm ti - CODO 90° SL 1000**

con espuma rígida PUR y protegida con revestimiento de PEHD

Diámetro exterior		Sistema										Uds./ Paquete	Uds./ Caja
d DN	D Re-vesti-miento	z	l	aquatherm green pipe ti SDR 9		aquatherm blue pipe ti SDR 11		aquatherm blue pipe ot ti SDR 11		aquatherm blue pipe ti SDR 17,6		m/pc	
				Art.-No.	Precio € m/pc	Art.-No.	Precio € m/pc	Art.-No.	Precio € m/pc	Art.-No.	Precio € m/pc		
32	90,00	225,00	1000,00	1383032020	242,04	2380032080	239,42	2480032020	250,77			1	10
40	110,00	225,00	1000,00	1383040021	292,44	2380040082	287,33	2480040022	301,05			1	10
50	110,00	225,00	1000,00	1383050022	321,01	2380050084	313,28	2480050024	326,38			1	10
63	125,00	225,00	1000,00	1383063023	377,41	2380063086	367,42	2480063026	385,89			1	10
75	140,00	225,00	1000,00	1383075024	444,78	2380075088	454,13	2480075028	476,59			1	10
90	160,00	225,00	1000,00	1383090025	541,97	2380090090	523,00	2480090030	548,33			1	10
110	200,00	225,00	1000,00	1383110026	650,76	2380110091	602,85	2480110031	633,29			1	10
125	225,00	225,00	1000,00	1383125027	799,85	2380125092	759,43	2480125032	796,48	2387125093	607,22	1	10
160	250,00	225,00	1000,00	1383160028	1.043,14	2384160094	881,69	2484160033	1.032,78	2387160095	737,72	1	10
200	315,00	225,00	1000,00	1383200029	1.364,40	2384200096	1.221,54	2484200034	1.338,32	2387200097	1.103,27	1	10
250	400,00	225,00	1000,00	1383250030	1.801,81	2384250098	1.582,36	2484250035	1.880,04	2387250099	1.501,51	1	10
315	450,00	225,00	1000,00	1383315031	2.676,64	2384315100	1.618,91			2387315101	1.782,23	1	10
355	500,00	225,00	1000,00			2384355102	2.160,88			2387355103	2.265,30	1	10

También disponibles en diseños de 60° y 75°  
 Disponible bajo solicitud: aquatherm green pipe ti SDR7,4

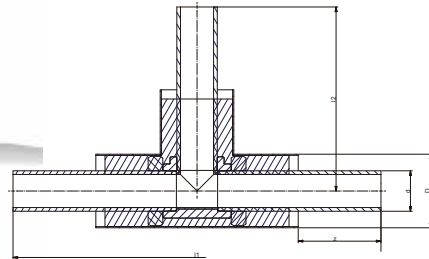
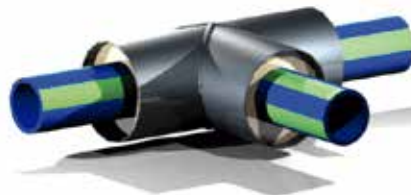

**aquatherm ti - DERIVACIÓN**

con espuma rígida PUR y protegida con revestimiento de PEHD

Diámetro exterior		Sistema										Uds./ Paquete	Uds./ Caja	
d DN	D Re-vesti-miento	z	l1	l2	aquatherm green pipe ti SDR 9		aquatherm blue pipe ti SDR 11		aquatherm blue pipe ot ti SDR 11		aquatherm blue pipe ti SDR 17,6		m/pc	
					Art.-No.	Precio € m/pc	Art.-No.	Precio € m/pc	Art.-No.	Precio € m/pc	Art.-No.	Precio € m/pc		
32	90,00	225,00	1000,00	500,00	1363032001	195,88	2360032001	189,39	2460032001	189,39			1	10
40	110,00	225,00	1000,00	500,00	1363040002	234,93	2360040002	228,44	2460040002	228,44			1	10
50	110,00	225,00	1000,00	500,00	1363050003	267,74	2360050003	261,13	2460050003	248,03			1	10
63	125,00	225,00	1000,00	500,00	1363063004	313,28	2360063004	300,30	2460063004	287,20			1	10
75	140,00	225,00	1000,00	500,00	1363075005	372,17	2360075005	359,07	2460075005	352,58			1	10
90	160,00	225,00	1000,00	500,00	1363090006	424,32	2360090006	405,35	2460090006	385,14			1	10
110	200,00	225,00	1000,00	500,00	1363110007	489,57	2360110007	463,49	2460110007	469,98			1	10
125	225,00	225,00	1000,00	500,00	1363125008	581,02	2360125008	548,33	2460125008	556,06	2367125040	398,24	1	10
160	250,00	225,00	1000,00	500,00	1363160009	835,53	2364160009	685,57	2464160009	633,29	2367160041	469,98	1	10
200	315,00	225,00	1500,00	750,00	1363200010	1.227,28	2364200010	1.077,20	2464200010	1.083,68	2367200042	946,69	1	10
250	400,00	225,00	1500,00	750,00	1363250011	1.677,80	2364250011	1.429,65	2464250011	1.566,76	2367250043	1.338,32	1	10
315	450,00	225,00	1500,00	750,00	1363315012	2.389,32	2364315012	1.853,96			2367315044	1.749,54	1	10
355	500,00	225,00	1500,00	750,00			2364355013	2.245,72			2367355045	1.860,58	1	10

Disponible bajo solicitud: aquatherm green pipe ti SDR7,4

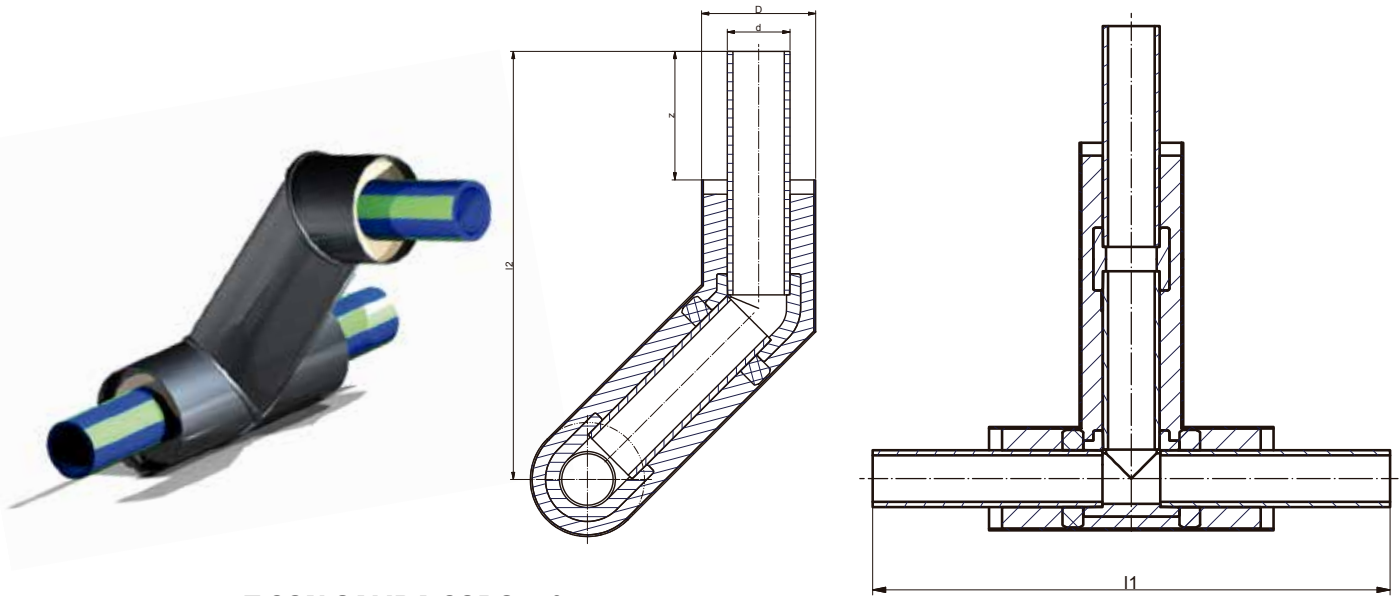

**aquatherm ti - T CON SALIDA CODO 45°**

con espuma rígida PUR y protegida con revestimiento de PEHD

Diámetro exterior		z	l1	l2	Sistema								Uds./ Pa-quete	Uds./ Caja
					aquatherm green pipe ti SDR 9		aquatherm blue pipe ti SDR 11		aquatherm blue pipe ot ti SDR 11		aquatherm blue pipe ti SDR 17,6			
d DN	D Re-vesti-miento				Art.-No.	Precio € m/pc	Art.-No.	Precio € m/pc	Art.-No.	Precio € m/pc	Art.-No.	Precio € m/pc	m/pc	
32	90,00	225,00	1000,00	750,00	1363032020	274,23	2360032020	261,13	2460032020	274,23			1	
40	110,00	225,00	1000,00	750,00	1363040021	332,87	2360040021	313,28	2460040021	332,87			1	
50	110,00	225,00	1000,00	750,00	1363050022	365,55	2360050022	346,09	2460050022	359,07			1	
63	125,00	225,00	1000,00	750,00	1363063023	424,32	2360063023	398,24	2460063023	417,70			1	
75	140,00	225,00	1000,00	750,00	1363075024	528,87	2360075024	496,05	2460075024	515,77			1	
90	160,00	225,00	1000,00	750,00	1363090025	607,22	2360090025	567,92	2460090025	593,99			1	
110	200,00	225,00	1000,00	750,00	1363110026	718,13	2360110026	659,37	2460110026	692,05			1	
125	225,00	225,00	1000,00	750,00	1363125027	900,91	2360125027	835,53	2460125027	874,83	2367125050	600,60	1	10
160	250,00	225,00	1000,00	1000,00	1363160028	1.312,25	2364160028	972,77	2464160028	1.038,02	2367160051	757,18	1	10
200	315,00	225,00	1500,00	1000,00	1363200029	1.775,61	2364200029	1.521,10	2464200029	1.547,30	2367200052	1.292,66	1	10
250	400,00	225,00	1500,00	1000,00	1363250030	2.493,87	2364250030	2.023,76	2464250030	2.226,25	2367250053	1.801,81	1	10
315	450,00	225,00	1500,00	1250,00	1363315180	3.342,50	2364315031	2.944,26			2367315054	2.552,51	1	10
355	500,00	225,00	1500,00	1250,00			2364355032	3.753,71			2367355055	2.924,67	1	10

Disponible bajo solicitud: aquatherm green pipe ti SDR 7,4

aquatherm ti pre-aislado

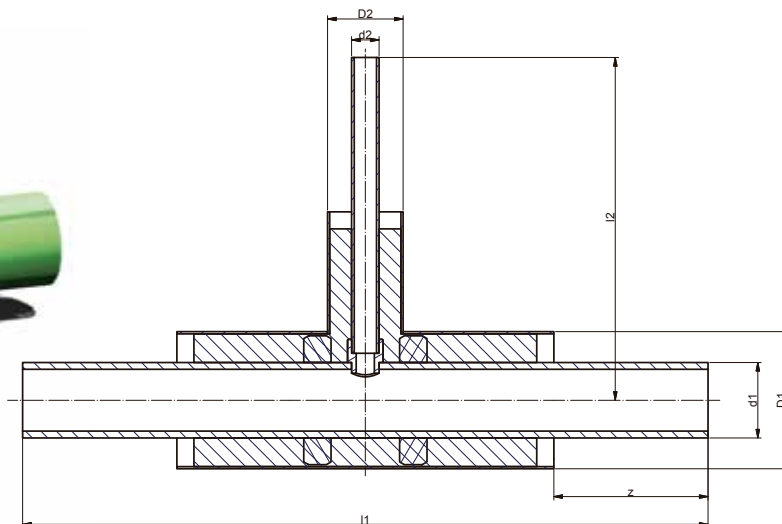

### aquatherm ti - T REDUCIDA SL 500

con espuma rígida PUR y protegida con revestimiento de PEHD

Diámetro exterior							Sistema							
d1 DN	d2 Diámetro nominal	D1 Revesti- miento	D2 Revesti- miento	z	l1	l2	aquatherm green pipe ti SDR 9		aquatherm blue pipe ti SDR 11		aquatherm blue pipe ot ti SDR 11		aquatherm blue pipe ti SDR 17,6	
							Art.-No.	Precio € m/pc	Art.-No.	Precio € m/pc	Art.-No.	Precio € m/pc	Art.-No.	Precio € m/pc
40	32	110,00	90	225,00	1000,00	500,00	1363040040	215,46	2360040060	202,36	2460040220	208,85		
50	32	110,00	90	225,00	1000,00	500,00	1363050041	224,57	2360050061	215,46	2460050221	221,95		
50	40	110,00	110	225,00	1000,00	500,00	1363050042	237,67	2360050062	228,44	2460050222	234,93		
63	32	125,00	90	225,00	1000,00	500,00	1363063043	254,51	2360063063	241,54	2460063223	254,51		
63	40	125,00	110	225,00	1000,00	500,00	1363063044	261,13	2360063064	248,03	2460063224	261,13		
63	50	125,00	110	225,00	1000,00	500,00	1363063045	267,74	2360063065	254,51	2460063225	267,74		
75	32	140,00	90	225,00	1000,00	500,00	1363075046	300,30	2360075066	287,20	2460075226	300,30		
75	40	140,00	110	225,00	1000,00	500,00	1363075047	313,28	2360075067	293,81	2460075227	306,79		
75	50	140,00	110	225,00	1000,00	500,00	1363075048	314,65	2360075068	300,30	2460075228	313,28		
75	63	140,00	125	225,00	1000,00	500,00	1363075049	326,38	2360075069	306,79	2460075229	319,89		
90	32	160,00	90	225,00	1000,00	500,00	1363090050	339,35	2360090070	319,89	2460090230	339,35		
90	40	160,00	110	225,00	1000,00	500,00	1363090051	352,58	2360090071	332,87	2460090231	346,09		
90	50	160,00	110	225,00	1000,00	500,00	1363090052	359,07	2360090072	339,35	2460090232	352,58		
90	63	160,00	125	225,00	1000,00	500,00	1363090053	372,17	2360090073	346,09	2460090233	365,55		
90	75	160,00	140	225,00	1000,00	500,00	1363090054	391,63	2360090074	365,55	2460090234	385,14		
110	32	200,00	90	225,00	1000,00	500,00	1363110055	261,13	2360110075	234,93	2460110235	248,03		
110	40	200,00	110	225,00	1000,00	500,00	1363110056	280,71	2360110076	254,51	2460110236	267,74		
110	50	200,00	110	225,00	1000,00	500,00	1363110057	300,30	2360110077	267,74	2460110237	287,20		
110	63	200,00	125	225,00	1000,00	500,00	1363110058	424,32	2360110078	398,24	2460110238	417,70		
110	75	200,00	140	225,00	1000,00	500,00	1363110059	437,42	2360110079	411,22	2460110239	424,32		
110	90	200,00	160	225,00	1000,00	500,00	1363110060	457,00	2360110080	417,70	2460110240	437,42		
125	32	225,00	90	225,00	1000,00	500,00	1363125061	287,20	2360125081	254,51	2460125241	267,74	2367125335	234,93
125	40	225,00	110	225,00	1000,00	500,00	1363125062	313,28	2360125082	280,71	2460125242	293,81	2367125336	248,03
125	50	225,00	110	225,00	1000,00	500,00	1363125063	319,89	2360125083	287,20	2460125243	300,30	2367125337	267,74
125	63	225,00	125	225,00	1000,00	500,00	1363125064	346,09	2360125084	313,28	2460125244	326,38	2367125338	287,20
125	75	225,00	140	225,00	1000,00	500,00	1363125065	522,25	2360125085	483,08	2460125245	502,67	2360125339	437,42
125	90	225,00	160	225,00	1000,00	500,00	1363125066	561,43	2360125086	515,77	2460125246	541,84	2367125340	463,49
125	110	225,00	200	225,00	1000,00	500,00	1363125067	574,40	2360125087	528,87	2460125247	554,94	2360125341	489,57
160	32	250,00	90	225,00	1000,00	500,00	1363160068	359,07	2364160088	306,79	2464160248	346,09	2367160342	300,30
160	40	250,00	110	225,00	1000,00	500,00	1363160069	378,65	2364160089	326,38	2464160249	378,65	2367160343	326,38
160	50	250,00	110	225,00	1000,00	500,00	1363160070	391,63	2364160090	339,35	2464160250	385,14	2367160344	332,87
160	63	250,00	125	225,00	1000,00	500,00	1363160071	417,70	2364160091	365,55	2464160251	417,70	2367160345	339,35
160	75	250,00	140	225,00	1000,00	500,00	1363160072	469,98	2360160092	411,22	2464160252	450,52	2367160346	378,65
160	90	250,00	160	225,00	1000,00	500,00	1363160073	509,15	2364160093	443,90	2464160253	469,98	2367160347	391,63
160	110	250,00	200,00	225,00	1500,00	750,00	1363160074	1.018,31	2364160094	900,91	2464160254	979,26	2367160348	763,79
160	125	250,00	225,00	225,00	1500,00	750,00	1363160075	1.064,10	2364160095	939,96	2464160255	985,74	2367160349	816,07

Disponible bajo solicitud: aquatherm green pipe ti SDR7,4

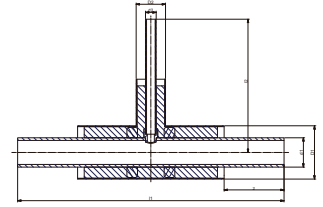

## aquatherm ti - T REDUCIDA SL 750

con espuma rígida PUR y protegida con revestimiento de PEHD

Diámetro exterior				Sistema											
				aquatherm green pipe ti SDR 9		aquatherm blue pipe ti SDR 11		aquatherm blue pipe ot ti SDR 11		aquatherm blue pipe ti SDR 17,6					
d1 Diámetro nominal	d2 Diámetro nominal	D1 Revestimiento	D2 Revestimiento	z	l1	l2	Art.-No.	Precio € m/pc	Art.-No.	Precio € m/pc	Art.-No.	Precio € m/pc	Art.-No.	Precio € m/pc	
200	32	315,00	90	225,00	1500,00	750,00	1363200076	651,51	2364200096	535,35	2464200256	548,33	2367200350	489,57	
200	40	315,00	110	225,00	1500,00	750,00	1363200077	665,85	2364200097	554,94	2464200257	561,43	2367200351	509,15	
200	50	315,00	110	225,00	1500,00	750,00	1363200078	685,57	2364200098	574,40	2464200258	587,50	2367200352	522,25	
200	63	315,00	125	225,00	1500,00	750,00	1363200079	711,64	2364200099	678,83	2464200259	626,68	2367200353	548,33	
200	75	315,00	140	225,00	1500,00	750,00	1363200080	770,41	2364200100	652,75	2464200260	672,34	2367200354	593,99	
200	90	315,00	160	225,00	1500,00	750,00	1363200081	802,97	2364200101	685,57	2464200261	711,64	2367200355	626,68	
200	110	315,00	200	225,00	1500,00	750,00	1363200082	855,12	2364200102	731,11	2464200262	744,21	2367200356	665,85	
200	125	315,00	225	225,00	1500,00	750,00	1363200083	887,81	2364200103	750,69	2464200263	816,07	2367200357	698,54	
200	160	315,00	250	225,00	1500,00	750,00	1363200084	1.188,11	2364200104	1.103,27	2464200264	1.135,96	2367200358	1.024,92	
250	32	400,00	90	225,00	1500,00	750,00	1363250085	913,88	2364250105	744,21	2464250265	796,48	2367250359	685,57	
250	40	400,00	110	225,00	1500,00	750,00	1363250086	939,96	2364250106	770,41	2464250266	835,53	2367250360	705,03	
250	50	400,00	110	225,00	1500,00	750,00	1363250087	953,18	2364250107	783,38	2464250267	848,63	2367250361	718,13	
250	63	400,00	125	225,00	1500,00	750,00	1363250088	979,26	2364250108	809,46	2464250268	874,83	2367250362	737,72	
250	75	400,00	140	225,00	1500,00	750,00	1363250089	1.038,02	2364250109	861,73	2464250269	907,39	2367250363	789,99	
250	90	400,00	160	225,00	1500,00	750,00	1363250090	1.070,58	2364250110	887,81	2464250270	946,69	2367250364	816,07	
250	110	400,00	200	225,00	1500,00	750,00	1363250091	1.116,37	2364250111	933,47	2464250271	998,84	2367250365	855,12	
250	125	400,00	225	225,00	1500,00	750,00	1363250092	1.168,52	2364250112	979,26	2464250272	1.051,12	2367250366	900,91	
250	160	400,00	250	225,00	1500,00	750,00	1363250093	1.677,80	2364250113	1.383,98	2464250273	1.495,02	2367250367	1.286,17	
250	200	400,00	315	225,00	1500,00	750,00	1363250094	1.743,05	2364250114	1.423,16	2464250274	1.605,94	2367250368	1.325,22	
315	32	450,00	90	225,00	1500,00	750,00	1363315095	1.573,37	2364315115	1.018,31			2367315369	926,98	
315	40	450,00	110	225,00	1500,00	750,00	1363315096	1.605,94	2364315116	1.038,02			2367315370	946,69	
315	50	450,00	110	225,00	1500,00	750,00	1363315097	1.612,42	2364315117	1.051,12			2367315371	966,16	
315	63	450,00	125	225,00	1500,00	750,00	1363315098	1.625,65	2364315118	1.083,68			2367315372	985,74	
315	75	450,00	140	225,00	1500,00	750,00	1363315099	1.677,80	2364315119	1.116,37			2367315373	1.018,31	
315	90	450,00	160	225,00	1500,00	750,00	1363315100	1.690,77	2364315120	1.162,03			2367315374	1.064,10	
315	110	450,00	200	225,00	1500,00	750,00	1363315101	1.730,07	2364315121	1.214,31			2367315375	1.109,76	
315	125	450,00	225	225,00	1500,00	750,00	1363315102	1.756,15	2364315122	1.266,46			2367315376	1.162,03	
315	160	450,00	250	225,00	1500,00	750,00	1363315103	1.853,96	2364315123	1.299,15			2367315377	1.188,11	
315	200	450,00	315	225,00	1500,00	750,00	1363315104	2.193,44	2364315124	1.677,80			2367315378	1.560,27	
315	250	450,00	400	225,00	1500,00	750,00	1363315105	3.140,13	2364315125	1.716,97			2367315379	1.599,45	
355	32	500,00	90	225,00	1500,00	750,00			2364355126	1.299,15			2367355380	1.018,31	
355	40	500,00	110	225,00	1500,00	750,00			2364355127	1.338,32			2367355381	1.057,61	
355	50	500,00	110	225,00	1500,00	750,00			2364355128	1.377,50			2367355382	1.083,68	
355	63	500,00	125	225,00	1500,00	750,00			2364355129	1.423,16			2367355383	1.116,37	
355	75	500,00	140	225,00	1500,00	750,00			2364355130	1.468,95			2367355384	1.148,93	
355	90	500,00	160	225,00	1500,00	750,00			2364355131	1.508,00			2367355385	1.181,62	
355	110	500,00	200	225,00	1500,00	750,00			2364355132	1.553,79			2367355386	1.227,28	
355	125	500,00	225	225,00	1500,00	750,00			2364355133	1.599,45			2367355387	1.259,97	
355	160	500,00	250	225,00	1500,00	750,00			2364355134	1.775,61			2367355388	1.390,60	
355	200	500,00	315	225,00	1500,00	750,00			2364355135	1.925,83			2367355389	1.514,49	
355	250	500,00	400	225,00	1500,00	750,00			2364355136	2.637,34			2367355390	2.213,03	
355	315	500,00	450	225,00	1500,00	750,00			2364355137	2.826,86			2367355391	2.363,24	

Disponible bajo solicitud: aquatherm green pipe ti SDR 7,4

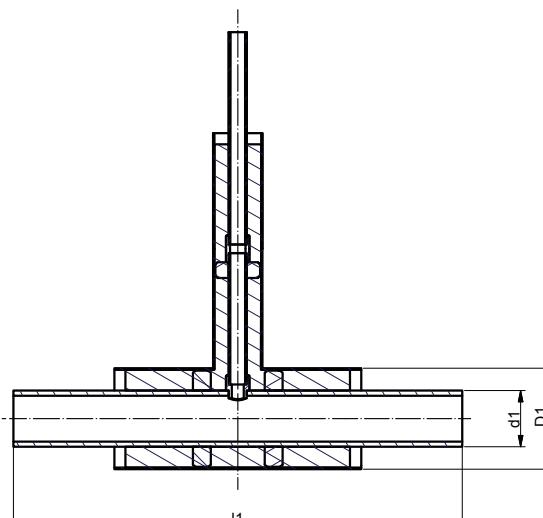
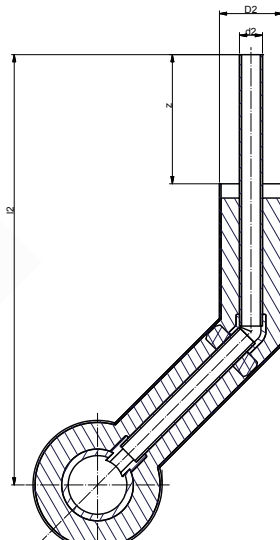

**aquatherm ti - T REDUCIDA CON SALIDA CODO 45° SL 500/750**

con espuma rígida PUR y protegida con revestimiento de PEHD

Diámetro exterior							Sistema							
							aquatherm green pipe ti SDR 9		aquatherm blue pipe ti SDR 11		aquatherm blue pipe ot ti SDR 11		aquatherm blue pipe ti SDR 17,6	
d1 Diámetro nominal	d2 Diámetro nominal	D1 Revestimiento	D2 Revestimiento	z	l1	l2	Art.-No.	Precio € m/pc	Art.-No.	Precio € m/pc	Art.-No.	Precio € m/pc		
40	32	110,00	90	225,00	1000,00	750,00	1363040106	300,30	2360040138	287,20	2460040280	300,30		
50	32	110,00	90	225,00	1000,00	750,00	1363050107	313,28	2360050139	300,30	2460050281	313,28		
50	40	110,00	110	225,00	1000,00	750,00	1363050108	352,58	2360050140	332,87	2460050282	346,09		
63	32	125,00	90	225,00	1000,00	750,00	1363063109	339,35	2360063141	319,89	2460063283	339,35		
63	40	125,00	110	225,00	1000,00	750,00	1363063110	378,65	2360063142	352,58	2460063284	372,17		
63	50	125,00	110	225,00	1000,00	750,00	1363063111	391,63	2360063143	372,17	2460063285	391,63		
75	32	140,00	90	225,00	1000,00	750,00	1363075112	378,65	2360075144	365,55	2460075286	385,14		
75	40	140,00	110	225,00	1000,00	750,00	1363075113	417,70	2360075145	398,24	2460075287	417,70		
75	50	140,00	110	225,00	1000,00	750,00	1363075114	437,42	2360075146	411,22	2460075288	430,93		
75	63	140,00	125	225,00	1000,00	750,00	1363075115	469,98	2360075147	443,90	2460075289	469,98		
90	32	160,00	90	225,00	1000,00	750,00	1363090116	424,32	2360090148	398,24	2460090290	424,32		
90	40	160,00	110	225,00	1000,00	750,00	1363090117	457,00	2360090149	430,93	2460090291	450,52		
90	50	160,00	110	225,00	1000,00	750,00	1363090118	476,59	2360090150	450,52	2460090292	469,98		
90	63	160,00	125	225,00	1000,00	750,00	1363090119	515,77	2360090151	483,08	2460090293	509,15		
90	75	160,00	140	225,00	1000,00	750,00	1363090120	574,40	2360090152	541,84	2460090294	567,92		
110	32	200,00	90	225,00	1000,00	750,00	1363110121	352,58	2360110153	319,89	2460110295	339,35		
110	40	200,00	110	225,00	1000,00	750,00	1363110122	398,24	2360110154	359,07	2460110296	378,65		
110	50	200,00	110	225,00	1000,00	750,00	1363110123	424,32	2360110155	385,14	2460110297	404,73		
110	63	200,00	125	225,00	1000,00	750,00	1363110124	567,92	2360110156	528,87	2460110298	554,94		
110	75	200,00	140	225,00	1000,00	750,00	1363110125	626,68	2360110157	581,02	2460110299	607,22		
110	90	200,00	160	225,00	1000,00	750,00	1363110126	665,85	2360110158	613,70	2460110300	646,27		
125	32	225,00	90	225,00	1000,00	750,00	1363125127	378,65	2360125159	339,35	2460125301	359,07	2367125400	319,89
125	40	225,00	110	225,00	1000,00	750,00	1363125128	417,70	2360125160	378,65	2460125302	391,63	2367125401	346,09
125	50	225,00	110	225,00	1000,00	750,00	1363125129	443,90	2360125161	404,73	2460125303	424,32	2367125402	372,17
125	63	225,00	125	225,00	1000,00	750,00	1363125130	496,05	2360125162	450,52	2460125304	469,98	2360125403	404,73
125	75	225,00	140	225,00	1000,00	750,00	1363125131	731,11	2360125163	678,83	2460125305	711,64	2360125404	607,22
125	90	225,00	160	225,00	1000,00	750,00	1363125132	770,41	2360125164	718,13	2460125306	750,69	2360125405	646,27
125	110	225,00	200	225,00	1000,00	750,00	1363125133	822,56	2360125165	763,79	2460125307	796,48	2360125406	685,57
160	32	250,00	90	225,00	1000,00	750,00	1363160134	450,52	2364160166	391,63	2464160308	430,93	2367160407	359,07
160	40	250,00	110	225,00	1000,00	750,00	1363160135	489,57	2364160167	430,93	2464160309	483,08	2367160408	404,73
160	50	250,00	110	225,00	1000,00	750,00	1363160136	522,25	2364160168	457,00	2464160310	489,57	2367160409	411,22
160	63	250,00	125	225,00	1000,00	750,00	1363160137	567,92	2364160169	502,67	2464160311	515,77	2367160410	437,42
160	75	250,00	140	225,00	1000,00	750,00	1363160138	659,37	2364160170	587,50	2464160312	626,68	2367160411	509,15
160	90	250,00	160	225,00	1000,00	750,00	1363160139	718,13	2364160171	639,78	2464160313	672,34	2367160412	554,94
160	110	250,00	200	225,00	1000,00	750,00	1363160140	1.259,97	2364160172	1.096,66	2464160314	1.201,21	2367160413	829,04
160	125	250,00	225	225,00	1000,00	1000,00	1363160141	1.397,08	2364160173	1.207,82	2464160315	1.272,95	2367160414	1.011,82

Disponible bajo solicitud: aquatherm green pipe ti SDR7,4



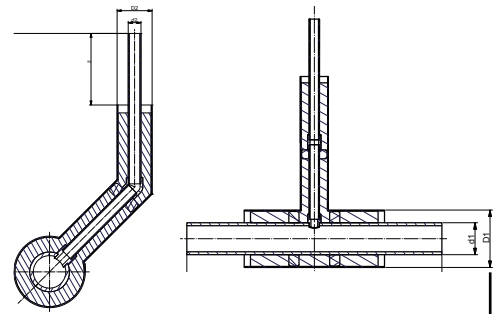

**aquatherm ti - T REDUCIDA CON SALIDA CODO 45° SL 500/750**

con espuma rígida PUR y protegida con revestimiento de PEHD

Diámetro exterior				Sistema											
				aquatherm green pipe ti SDR 9		aquatherm blue pipe ti SDR 11		aquatherm blue pipe ot ti SDR 11		aquatherm blue pipe ti SDR 17,6					
d1 Diámetro nominal	d2 Diámetro nominal	D1 Revestimiento	D2 Revestimiento	z	l1	l2	Art.-No.	Precio € m/pc	Art.-No.	Precio € m/pc	Art.-No.	Precio € m/pc	Art.-No.	Precio € m/pc	
200	32	315,00	90	225,00	1000,00	750,00	1363200142	554,94	2364200174	463,49	2464200316	548,33	2367200415	469,98	
200	40	315,00	110	225,00	1000,00	1000,00	1363200143	593,99	2364200175	509,15	2464200317	581,02	2367200416	489,57	
200	50	315,00	110	225,00	1000,00	1000,00	1363200144	626,68	2364200176	535,35	2464200318	639,78	2367200417	528,87	
200	63	315,00	125	225,00	1000,00	1000,00	1363200145	672,34	2364200177	581,02	2464200319	665,85	2367200418	561,43	
200	75	315,00	140	225,00	1000,00	1000,00	1363200146	763,79	2364200178	665,85	2464200320	737,72	2367200419	626,68	
200	90	315,00	160	225,00	1000,00	1000,00	1363200147	822,56	2364200179	718,13	2464200321	783,38	2367200420	672,34	
200	110	315,00	200	225,00	1000,00	1000,00	1363200148	933,47	2364200180	816,07	2464200322	907,39	2367200421	789,99	
200	125	315,00	225	225,00	1500,00	1000,00	1363200149	1.847,48	2364200181	1.573,37	2464200323	1.592,84	2367200422	1.397,08	
200	160	315,00	250	225,00	1500,00	1000,00	1363200150	2.082,53	2364200182	1.736,56	2464200324	1.697,26	2367200423	1.455,85	
250	32	400,00	90	225,00	1000,00	1000,00	1363250151	737,72	2364250183	607,22	2464250325	731,11	2367250424	587,50	
250	40	400,00	110	225,00	1000,00	1000,00	1363250152	789,99	2364250184	659,37	2464250326	757,18	2367250425	646,27	
250	50	400,00	110	225,00	1000,00	1000,00	1363250153	816,07	2364250185	685,57	2464250327	789,99	2367250426	672,34	
250	63	400,00	125	225,00	1000,00	1000,00	1363250154	868,34	2364250186	731,11	2464250328	887,81	2367250427	724,62	
250	75	400,00	140	225,00	1000,00	1000,00	1363250155	959,67	2364250187	809,46	2464250329	959,67	2367250428	802,97	
250	90	400,00	160	225,00	1000,00	1000,00	1363250156	1.024,92	2364250188	874,83	2464250330	1.031,53	2367250429	861,73	
250	110	400,00	200	225,00	1000,00	1000,00	1363250157	1.116,37	2364250189	959,67	2464250331	1.109,76	2367250430	946,69	
250	125	400,00	225	225,00	1000,00	1000,00	1363250158	1.240,38	2364250190	1.070,58	2464250332	1.233,90	2367250431	1.077,20	
250	160	400,00	250	225,00	1500,00	1000,00	1363250159	2.526,43	2364250191	2.115,84	2464250333	2.154,39	2367250432	1.736,56	
250	200	400,00	315	225,00	1500,00	1000,00	1363250160	2.741,89	2364250192	2.415,52	2464250334	2.415,52	2367250433	1.893,26	
315	32	450,00	90	225,00	1000,00	1000,00	1363315161	1.077,20	2364315193	789,99			2367315434	776,89	
315	40	450,00	110	225,00	1000,00	1000,00	1363315162	1.122,86	2364315194	829,04			2367315435	802,97	
315	50	450,00	110	225,00	1000,00	1000,00	1363315163	1.129,47	2364315195	855,12			2367315436	835,53	
315	63	450,00	125	225,00	1000,00	1000,00	1363315164	1.162,03	2364315196	913,88			2367315437	874,83	
315	75	450,00	140	225,00	1000,00	1000,00	1363315165	1.233,90	2364315197	992,23			2367315438	946,69	
315	90	450,00	160	225,00	1000,00	1000,00	1363315166	1.272,95	2364315198	1.057,61			2367315439	998,84	
315	110	450,00	200	225,00	1000,00	1000,00	1363315167	1.351,30	2364315199	1.135,96			2367315440	1.090,17	
315	125	450,00	225	225,00	1000,00	1000,00	1363315168	1.468,95	2364315200	1.246,87			2367315441	1.201,21	
315	160	450,00	250	225,00	1000,00	1000,00	1363315169	1.618,91	2364315201	1.357,78			2367315442	1.325,22	
315	200	450,00	315	225,00	1500,00	1000,00	1363315170	3.029,10	2364315202	3.179,31			2367315443	2.454,57	
315	250	450,00	400	225,00	1500,00	1000,00	1363315171	3.662,39	2364315203	3.277,25			2367315444	2.624,37	
355	32	500,00	90	225,00	1000,00	1000,00			2364355204	1.214,31			2367355445	972,77	
355	40	500,00	110	225,00	1000,00	1000,00			2364355205	1.253,36			2367355446	998,84	
355	50	500,00	110	225,00	1000,00	1000,00			2364355206	1.292,66			2367355447	1.031,53	
355	63	500,00	125	225,00	1000,00	1000,00			2364355207	1.338,32			2367355448	1.057,61	
355	75	500,00	140	225,00	1000,00	1000,00			2364355208	1.371,01			2367355449	1.096,66	
355	90	500,00	160	225,00	1000,00	1000,00			2364355209	1.410,06			2367355450	1.127,97	
355	110	500,00	200	225,00	1000,00	1000,00			2364355210	1.455,85			2367355451	1.162,03	
355	125	500,00	225	225,00	1000,00	1000,00			2364355211	1.488,41			2367355452	1.201,21	
355	160	500,00	250	225,00	1000,00	1000,00			2364355212	2.219,52			2367355453	1.769,13	
355	200	500,00	315	225,00	1000,00	1000,00			2364355213	2.402,42			2367355454	1.925,83	
355	250	500,00	400	225,00	1500,00	1000,00			2364355214	3.290,22			2367355455	2.807,15	
355	315	500,00	450	225,00	1500,00	1000,00			2364355215	3.525,28			2367355456	3.016,12	

Disponible bajo solicitud: aquatherm green pipe ti SDR7,4

aquatherm ti pre-aislado

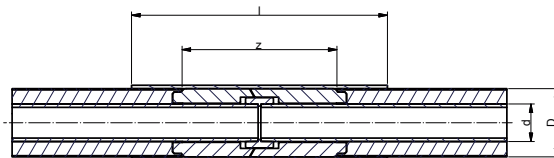

**aquatherm ti - MANGUITO WTD NUEVO**

compuesto de manga retráctil con espuma rígida PUR, elementos aislantes y accesorios , 600 mm de longitud total

Diámetro exterior		Sistema				Uds./Paquete	Uds./Caja
Diámetro nominal d	Revestimiento D	z	l	aquatherm ti			
Art.-No.	Precio € m/pc						
Soldadura a enchufe:El manguito para la unión con soldadura a enchufe está incluido en el suministro							
32	90,00	454,50	600	1390032022	180,16	1	
40	110,00	456,50	600	1390040024	189,39	1	
50	110,00	456,00	600	1390050026	189,39	1	
63	125,00	455,50	600	1390063028	208,85	1	
75	140,00	456,50	600	1390075030	208,85	1	
90	160,00	456,50	600	1390090032	234,93	1	
110	200,00	458,00	600	1390110034	267,74	1	
125	225,00	460,00	600	1390125036	300,30	1	
Soldadura a tope: no necesita manguito de conexión							
160	250,00	445,00	600	1390160038	319,89	1	
200	315,00	444,00	600	1390200040	365,55	1	
250	400,00	444,00	600	1390250042	443,90	1	
315	450,00	444,00	600	1390315044	450,52	1	
355	500,00	444,00	600	1390355045	489,57	1	

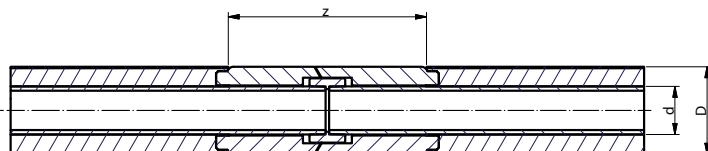

**aquatherm ti - SET DE AISLAMIENTO PARA MANGUITO**

Incluye elementos de espuma rígida PUR y elementos de ajuste dependiendo de la dimensión (Manguitos de hasta 125 mm).

Accesorios necesarios para la instalación: Cintas de protección de aislamiento e imprimación (p. 80)

Diámetro exterior		Sistema				Uds./Paquete	Uds./Caja
Diámetro nominal d	Revestimiento D	z	Art.-No.	aquatherm ti			
Art.-No.	Precio € m/pc						
Soldadura a enchufe:El manguito para la unión con soldadura a enchufe está incluido en el suministro							
32	90,00	454,50	1340032114	71,74	1		
40	110,00	456,50	1340040115	78,23	1		
50	110,00	456,00	1340050116	78,23	1		
63	125,00	455,50	1340063117	84,96	1		
75	140,00	456,50	1340075118	84,96	1		
90	160,00	456,50	1340090119	91,45	1		
110	200,00	458,00	1340110120	97,94	1		
125	225,00	460,00	1340125121	104,43	1		
Soldadura a tope: no necesita manguito de conexión							
160	250,00	445,00	1340160122	111,04	1		
200	315,00	444,00	1340200123	117,53	1		
250	400,00	444,00	1340250124	137,11	1		
315	450,00	444,00	1340315125	143,60	1		
355	500,00	444,00	1347355126	182,78	1		

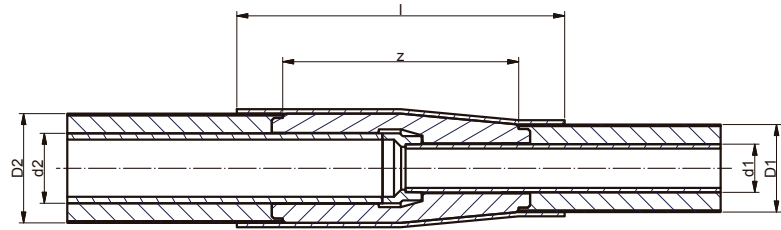

### aquatherm ti - REDUCCIÓN

incluye un manguito reductor autoretráctil, elementos de espuma rígida PUR, ajuste dependiente de dimensiones y accesorio, longitud total de 900mm.

Diámetro exterior				Sistema				Uds./ Paquete	Uds./ Caja
d1 Diámetro nominal	d2 Diámetro nominal	D1 Revesti- miento	D2 Revesti- miento	z	l	Art.-No.	Precio € m/pc		
Soldadura a enchufe: hasta 125 x 110 mm, despues en un lado manguito y en el otro lado soldadura a tope									
40	32	90,00	110	456,00	900,00	1340040103	254,51	1	10
50	32	90,00	110	456,00	900,00	1340050104	280,71	1	10
50	40	110,00	125	456,00	900,00	1340050105	280,71	1	10
63	40	110,00	125	455,50	900,00	1340063106	287,20	1	10
63	50	110,00	140	455,50	900,00	1340063107	287,20	1	10
75	50	110,00	140	456,50	900,00	1340075108	313,28	1	10
75	63	125,00	160	456,50	900,00	1340075109	319,89	1	10
90	63	125,00	160	456,50	900,00	1340090110	378,65	1	10
90	75	140,00	200	456,50	900,00	1340090111	385,14	1	10
110	75	140,00	200	458,00	900,00	1340110112	443,90	1	10
110	90	160,00	225	458,00	900,00	1340110113	443,90	1	10
125	90	160,00	225	458,00	900,00	1390125020	515,77	1	10
125	110	200,00	250	460,00	900,00	1390125021	528,87	1	10

Diámetro exterior				aquatherm green pipe ti SDR 9		aquatherm blue pipe ti SDR 11		aquatherm blue pipe ti SDR 17,6			
d1 Diá- metro nominal	d2 Diá- metro nominal	D1 Revesti- miento	D2 Revesti- miento	z	l	Art.-No.	Precio € m/pc	Art.-No.	Precio € m/pc	Art.-No.	Precio € m/pc
160	110	200	250	540,00	750,00	2340160001	593,99	2340160020	581,02	2347160060	561,43
160	125	225	315	540,00	750,00	2340160003	607,22	2340160021	593,99	2347160062	574,40
200	125	225	315	585,00	750,00	2340200005	685,57	2340200022	665,85	2347200064	646,27
Ambas caras - Soldadura a tope											
200	160	250	400	585,00	750,00	2340200007	685,57	2340200023	672,34	2347200066	646,27
250	160	250	400	622,00	750,00	2340250009	939,96	2340250024	913,88	2347250068	881,32
250	200	315	400	622,00	750,00	2340250011	946,69	2340250025	920,49	2347250070	894,42
315	200	315	450	622,00	750,00	2340315013	1.162,03	2340315026	1.011,82	2347315072	979,26
315	250	400	450	622,00	750,00	2340315015	1.762,64	2340315027	1.064,10	2347315074	1.031,53
355	250	400	500	622,00	750,00			2344355028	1.162,03	2347355076	1.135,96
355	315	450	500	622,00	750,00			2344355029	1.227,28	2347355078	1.194,60

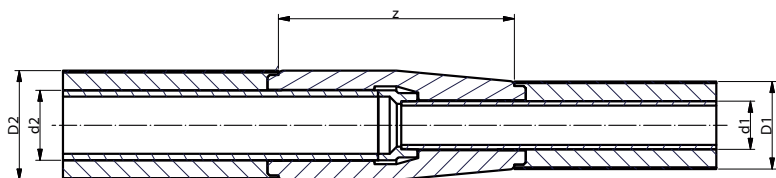

### aquatherm ti - SET DE AISLAMIENTO PARA REDUCCIÓN

Incluye elementos de espuma rígida PUR y elementos de ajuste.

Accesorios necesarios para la instalación: Cintas de protección de aislamiento e imprimación (p. 80)

Diámetro exterior						Sistema					
						aquatherm ti					
d2	d1	D1	D2	z	l	Art.-No.		Precio €		m/pc	
Soldadura a enchufe: hasta 125 x 110 mm, despues en un lado manguito y en el otro lado soldadura a tope											
40	32	90,00	110	456,00	900,00	2340040030		71,74			
50	32	90,00	110	456,00	900,00	2340050031		71,74			
50	40	110,00	125	456,00	900,00	2340050032		71,74			
63	40	110,00	125	455,50	900,00	2340063033		71,74			
63	50	110,00	140	455,50	900,00	2340063034		71,74			
75	50	110,00	140	456,50	900,00	2340075035		72,36			
75	63	125,00	160	456,50	900,00	2340075036		74,23			
90	63	125,00	160	456,50	900,00	2340090037		111,04			
90	75	140,00	200	456,50	900,00	2340090038		117,53			
110	75	140,00	200	458,00	900,00	2340110039		130,50			
110	90	160,00	225	458,00	900,00	2340110040		137,11			
125	90	160,00	225	458,00	900,00	2340125041		150,09			
125	110	200,00	250	460,00	900,00	2340125042		156,58			
Diámetro exterior						aquatherm green pipe ti SDR 9		aquatherm blue pipe ti SDR 11		aquatherm blue pipe ti SDR 17,6	
d2	d1	D1	D2	z	l	Art.-No.	Precio € m/pc	Art.-No.	Precio € m/pc	Art.-No.	Precio € m/pc
160	110	200,00	250	540,00	750,00	2340160002	182,78	2344160050	176,29	2347160061	169,68
160	125	225,00	315	540,00	750,00	2340160004	202,36	2344160051	195,88	2347160063	189,39
200	125	225,00	315	585,00	750,00	2340200006	241,54	2344200052	234,93	2347200065	228,44
Ambas caras - Soldadura a tope											
200	160	250,00	400	585,00	750,00	2340200008	287,20	2344200053	280,71	2347200067	267,74
250	160	250,00	400	622,00	750,00	2340250010	359,07	2344250054	352,58	2347250069	339,35
250	200	315,00	400	622,00	750,00	2340250012	385,14	2344250055	372,17	2347250071	359,07
315	200	315,00	450	622,00	750,00	2340315014	398,24	2344315056	385,14	2347315073	372,17
315	250	400,00	450	622,00	750,00	2340315016	411,22	2344315057	398,24	2347315075	385,14
355	250	400,00	500	622,00	750,00			2344355058	424,32	2347355077	391,63
355	315	400,00	500	622,00	750,00			2344355059	443,90	2347355079	411,22

### ACCESORIOS DE MONTAJE

#### aquatherm ti - CINTA DE PROTECCIÓN DE AISLAMIENTO

para aislamiento de las conexiones del set de aislamiento aquatherm

Art.-No.	Anchura	Longitud	Uds./Paquete	Uds./Caja
9702411000	50 mm	15 m	1	78,23
9702411001	100 mm	15 m	1	156,58
11001491	300 mm	10 m	1	399,24

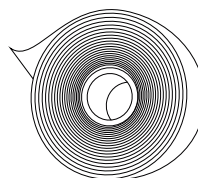

**aquatherm ti - IMPRIMACIÓN**

Art.-No.	Cantidad	Precio € m/pc	Uds./Paquete	Uds./Caja
9702411002	1 litro	82,70	1	111,04

**aquatherm ti - COLLAR DE CIERRE**

Collar para el cierre de la capa aislante de PUR y la cubierta sobre la tubería interna

Diámetro exterior		Sistema		Uds./Paquete	Uds./Caja
Diámetro nominal	Revestimiento	aquatherm ti			
Art.-No.	Precio € m/pc				
32 mm	90 mm	2390032001	78,23	1	
40-50 mm	110 mm	2390050002	84,96	1	
63-75 mm	125-140 mm	2390075003	104,43	1	
90 mm	160 mm	2390090004	124,01	1	
110 mm	200 mm	2390110005	130,50	1	
125 mm	225 mm	2390125006	234,93	1	
160 mm	250 mm	2390160007	254,51	1	
200 mm	315 mm	2390200008	274,23	1	
250 mm	400 mm	2390250009	326,38	1	
315 mm	450 mm	2390315010	378,65	1	

**aquatherm ti - CIERRE COMPACTO**

Collar para el cierre de la capa aislante de PUR sobre la pared.

Diámetro exterior			Sistema		Uds./Paquete	Uds./Caja
Diámetro pasamuro	Diámetro nominal	Revestimiento	aquatherm ti			
Art.-No.	Precio € m/pc					
150	32	90	9701214212	868,34	1	
200	40-50	110	9701214214	1.038,02	1	
200	63	125	9701214218	1.051,12	1	
200	75	140	9701214220	1.057,61	1	
200	90	160	9701214222	1.357,78	1	
250	110	200	9701214224	1.769,13	1	
300	125	225	9701214226	2.173,98	1	
350	160	250	9701214230	2.180,47	1	
400	200	315	9701214234	2.735,28	1	
500	250	400	9701214238	3.557,96	1	
550	315	450	9701214242	4.178,03	1	
600	355	500	9701214244	4.328,24	1	

**aquatherm ti - CINTA DE ADVERTENCIA**

Art.-No.	Ancho	Precio € m/pc	Uds./Paquete	Uds./Caja
9700050191	40 mm	41,67	250m	10

Color: amarillo

Impreso en negro: "Attention district heating pipeline"



# BIM

## aquatherm

green blue red

OPEN BIM™



AUTODESK  
REVIT



GRAPHISOFT.  
ARCHICAD

Están disponibles los sistemas:

- ▶ **aquatherm blue pie** - **CLIMATIZACIÓN**
- ▶ **aquatherm green pipe** - **AGUA SANITARIA**
- ▶ **aquatherm red pipe** - **PCI**



Incluye de una amplia gama de accesorios y valvulería, que permite realizar todo tipo de diseños e interconexiones con el resto de sistemas y elementos.

- **Completa librería compacta:** en tan solo **36 MB**.
- **Open BIM.** Compatible con cualquier software: (*Revit / Archicad/...*).
- Familias completas de tuberías y accesorios.
- En diámetros desde **DN 20** hasta **DN 630** mm.
- Posibilidad de conexiones a cualquier ángulo necesario.
- **Inserción automática** de los accesorios durante el dibujo.
- **Total conectividad** con elementos de otras bibliotecas: (válvulas, bombas, maquinaria, etc..)
- Medición completa y detallada.
- Librería en **constante desarrollo** y actualización.
- Codos especiales para conectar las tuberías en edificios singulares.
- [www.aquatherm.es](http://www.aquatherm.es) en el apartado área técnica

# aquatherm red pipe

**Tuberías de polipropileno para protección contra incendios.**

**HOMOLOGADA POR EL NUEVO RIPCI 2017.**

	
<b>DOCUMENTO DE IDONEIDAD TÉCNICA: N° 617R/19</b>	
<b>Área genérica / Uso previsto:</b>	<b>Sistema de tubos y accesorios de PP-R para la alimentación de agua (red general de incendios) de sistemas de bocas de incendio equipadas (BIEs)</b>
<b>Nombre comercial:</b>	<b>AQUATHERM RED PIPE (Serie 5/SDR 11)</b>
<b>Beneficiario:</b>	<b>AQUATHERM GmbH</b>
<b>Sede Social y lugar de fabricación:</b>	Biggen 5, D-57439 ATTENDORN, Alemania www.aquatherm.de
<b>Representante en España:</b>	<b>AQUATHERM IBÉRICA, S.L.</b> C/ Carpinteros 15 28320 PINTO (Madrid), España
<b>Validez. Desde:</b>	25 de noviembre de 2019
<b>Hasta:</b>	25 de noviembre de 2024 (Condicionada a seguimiento anual)
<b>Este Documento consta de 16 páginas</b>	
 <b>MIEMBRO DE:</b> UNIÓN EUROPEA PARA LA EVALUACIÓN DE LA IDONEIDAD TÉCNICA UNION EUROPÉENNE POUR L'AGREMENT TECHNIQUE DANS LA CONSTRUCTION EUROPEAN UNION OF AGREEMENT EUROPÄISCHE UNION FÜR DAS AGREEMENT IN BAUWESEN	

	
<b>DOCUMENTO DE IDONEIDAD TÉCNICA: N° 618R/19</b>	
<b>Área genérica / Uso previsto:</b>	<b>Sistema de tubos y accesorios de PP-R para instalaciones de extinción de incendios por rociadores</b>
<b>Nombre comercial:</b>	<b>AQUATHERM RED PIPE (Serie 5/SDR 11)</b>
<b>Beneficiario:</b>	<b>AQUATHERM GmbH</b>
<b>Sede Social y lugar de fabricación:</b>	Biggen 5, D-57439 ATTENDORN, Alemania www.aquatherm.de
<b>Representante en España:</b>	<b>AQUATHERM IBÉRICA, S.L.</b> C/ Carpinteros 15 28320 PINTO (Madrid), España
<b>Validez. Desde:</b>	25 de noviembre de 2019
<b>Hasta:</b>	25 de noviembre de 2024 (Condicionada a seguimiento anual)
<b>Este Documento consta de 19 páginas</b>	
 <b>MIEMBRO DE:</b> UNIÓN EUROPEA PARA LA EVALUACIÓN DE LA IDONEIDAD TÉCNICA UNION EUROPÉENNE POUR L'AGREMENT TECHNIQUE DANS LA CONSTRUCTION EUROPEAN UNION OF AGREEMENT EUROPÄISCHE UNION FÜR DAS AGREEMENT IN BAUWESEN	



**aquatherm  
red pipe**



## APLICACIÓN: ROCIADORES AUTOMÁTICOS

Para la utilización de **aquatherm red pipe** en instalaciones de rociadores automáticos se debe tener en cuenta los siguientes aspectos, entre otros, según lo indicado en su Documento de Idoneidad Técnica DIT N°526R/19 y DIT N°618R/19:

- En cumplimiento de la Norma UNE-EN 12845:2005 "Sistemas fijos de lucha contra incendios - Sistemas de Rociadores automáticos: Diseño, instalación y mantenimiento" que en su apartado 17.1.2 admite el uso de otros materiales no metálicos.
- Las tuberías y accesorios de plástico no deben emplearse al aire libre, si no están convenientemente protegidas.
- Los sistemas de rociadores automáticos que empleen tuberías y accesorios plásticos sólo son aptos y autorizados para la instalación de sistemas húmedos, y serán diseñadas para redes ramificadas, aguas abajo del puesto de control y no debiendo disponer de válvulas de corte o elementos que impidan el flujo. (según EN 12845).
- No es apto el sistema para agua potable.
- Los rociadores a emplear serán homologados y con la limitación de: ampolla roja y temperatura normal de activación de 68°C.
- Su uso es apto para la protección de riesgos del tipo ligero (RL) y ordinario (**R01, R02, R03 y R04**) quedando exentos los riesgos elevados de almacenamiento y producción.
- Es válido para su uso en instalaciones vistas, tanto en zonas ocupables, pasillos y escaleras protegidas, aparcamientos y recintos de riesgo especial, así como en espacios ocultos (patinillos, falsos techos, etc.) de acuerdo con la calificación obtenida de reacción al fuego del Sistema B-s1,d0. Cuando la distribución discurra por líneas verticales deben estar integradas en espacios protegidos, como patinillos de servicio, convenientemente sectorizados.
- Se debe tener especial cuidado con la técnica de unión por soldadura. Para ello, es imprescindible cumplir las instrucciones del proceso de soldadura, especialmente en cuanto al tiempo

de enfriamiento, antes de poder aplicar presión hidráulica al sistema.

- Utilizar sólo abrazaderas isofónicas adecuadas para tal fin.
- La instalación debe realizarse por personal cualificado, según normativa vigente.
- El comportamiento del sistema de tubos y accesorios está concebido para una vida útil de más de 50 años, extrapolados de sus correspondientes curvas de referencia, sometido a una presión de servicio de 12 bar y a una temperatura del fluido de 20°C, con un factor de seguridad de 1,25.

## APLICACIÓN: BOCAS DE INCENDIO EQUIPADAS (BIEs)

Para la utilización de **aquatherm red pipe** en instalaciones de BIEs se debe tener en cuenta los siguientes aspectos, entre otros, según lo indicado en su Documento de Idoneidad Técnica DIT N°592R/19 y DIT N°617R/19:

- Su uso es apto para la protección contra incendios de riesgos del tipo bajo (**RB**), y medio (**RM**).
- Permite el uso para bocas de incendio equipadas tipo normalizada 25 mm y 45 mm.
- El Sistema, de acuerdo al Código Técnico de Edificación, permite el uso para bocas de incendio para edificios, establecimientos y/o zonas:
  - Hospitalario, en cualquier caso.
  - Administrativo y Docente.
  - Residencial.
  - Garaje o aparcamiento.
  - Comercial
  - Recintos de densidad elevada.



## aquatherm red pipe - Tubería Serie 3,2 / SDR 7,4 - Serie 5 / SDR 11

Material: fusiolen PP-R FS  
 Tubería series: SDR 7,4 / SDR 11  
 Suministro: barras de 5,8  
 Color: rojo con 4 franjas verdes

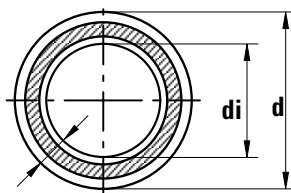

Serie	Art.-No.	Diámetro d [mm]	Espesor de pared (s) [mm]	Diámetro interior (di) [mm]	Capacidad [l/m]	Peso [kg]	longitud barra	ml / paquete	€ / ml
<b>soldadura a enchufe</b>									
3,2	3012025008	<b>25</b>	3,5	18,0	0,236	0,246	5,8	116	<b>5,12</b>
5	3014032010	<b>32</b>	2,9	26,2	0,539	0,285	5,8	58	<b>6,92</b>
	3014040012	<b>40</b>	3,7	32,6	0,834	0,435	5,8	58	<b>10,48</b>
	3014050014	<b>50</b>	4,6	40,8	1,307	0,675	5,8	29	<b>15,16</b>
	3014063016	<b>63</b>	5,8	51,4	2,074	1,065	5,8	17,4	<b>23,21</b>
	3014075018	<b>75</b>	6,8	61,4	2,959	1,482	5,8	17,4	<b>30,88</b>
	3014090020	<b>90</b>	8,2	73,6	4,252	2,145	5,8	11,6	<b>43,85</b>
	3014110022	<b>110</b>	10,0	90,0	6,359	3,175	5,8	5,8	<b>61,57</b>
3014125024	<b>125</b>	11,4	102,2	8,199	4,118	5,8	5,8	<b>84,90</b>	
<b>soldadura a tope</b>									
5	<b>3014160026</b>	<b>160</b>	14,6	130,8	15,792	4,360	5,8	5,8	<b>122,45</b>

Serie	Art.-No.	Diámetro d [mm]	Espesor de pared (s) [mm]	Diámetro interior (di) [mm]	Capacidad [l/m]	Peso [kg]	longitud barra	ml / paquete	€ / ml
<b>soldadura a enchufe</b>									
3,2	3012025008	<b>25</b>	3,5	18,0	0,236	0,246	5,8	116	<b>5,12</b>
	3012032010	<b>32</b>	4,4	23,2	0,379	0,394	5,8	58	<b>7,55</b>
	3012040012	<b>40</b>	5,5	29,0	0,590	0,613	5,8	58	<b>11,98</b>
	3012050014	<b>50</b>	6,9	36,2	0,919	0,955	5,8	29	<b>16,47</b>
	3012063016	<b>63</b>	8,6	45,8	1,444	1,500	5,8	17,4	<b>25,45</b>
	3012075018	<b>75</b>	10,3	54,4	2,054	2,135	5,8	17,4	<b>34,00</b>
	3012090020	<b>90</b>	12,3	65,4	2,943	3,058	5,8	11,6	<b>49,84</b>
	3012110022	<b>110</b>	15,1	79,8	4,403	4,576	5,8	5,8	<b>69,62</b>
	3012125024	<b>125</b>	17,1	90,8	5,669	5,891	5,8	5,8	<b>92,26</b>

### ACCESORIOS DE PP SIMPLES

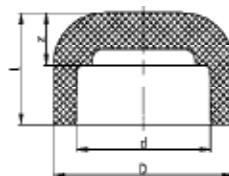

## aquatherm red pipe - Tapón

Serie	Art.-No.	Diámetro d [mm]	l	z	D	Peso [kg]	Uds / paquete	Uds / caja	€ / Ud
<b>soldadura a enchufe</b>									
3,2 5	3020025008	<b>25</b>	24,00	8,00	34,00	0,011	10	1500	<b>1,87</b>
	3020032010	<b>32</b>	31,50	13,50	43,00	0,019	5	1000	<b>2,25</b>
	3020040012	<b>40</b>	38,00	17,50	52,00	0,043	5	500	<b>3,18</b>
	3020050014	<b>50</b>	44,50	21,00	68,00	0,081	5	300	<b>5,43</b>
	3020063016	<b>63</b>	52,00	24,50	84,00	0,144	1	150	<b>9,11</b>
	3020075018	<b>75</b>	58,50	28,50	100,00	0,243	1	100	<b>12,23</b>
	3020090020	<b>90</b>	57,50	34,50	120,00	0,368	1	75	<b>31,75</b>
	3020110022	<b>110</b>	65,00	28,00	147,00	0,635	1	40	<b>35,00</b>
	3020125024	<b>125</b>	70,00	30,00	167,00	0,862	1	30	<b>49,34</b>
<b>soldadura a tope</b>									
5	3024160326	<b>160</b>	70	14,6	131,00	0,795	1	1	<b>61,20</b>

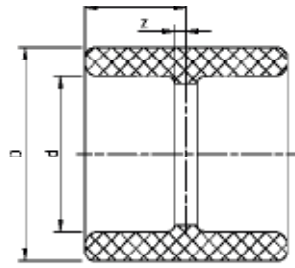

**aquatherm red pipe - Manguito**

Serie	Art.-No.	Diámetro d [mm]	l	z	D	Peso [kg]	Uds / paquete	Uds / caja	€ / Ud
<b>soldadura a enchufe</b>									
3,2 5	3040025020	<b>25</b>	17,50	1,50	34,00	0,014	10	1000	<b>0,83</b>
	3040032021	<b>32</b>	20,25	2,25	43,00	0,026	5	600	<b>1,30</b>
	3040040022	<b>40</b>	23,75	3,25	52,00	0,044	5	400	<b>2,16</b>
	3040050023	<b>50</b>	26,50	3,00	68,00	0,084	5	200	<b>3,74</b>
	3040063024	<b>63</b>	30,25	2,75	84,00	0,139	1	100	<b>6,99</b>
	3040075025	<b>75</b>	33,25	3,25	100,00	0,226	1	80	<b>9,48</b>
	3040090026	<b>90</b>	36,25	3,25	120,00	0,343	1	50	<b>21,89</b>
	3040110027	<b>110</b>	41,00	4,00	147,00	0,583	1	30	<b>35,25</b>
	3040125028	<b>125</b>	45,00	5,00	167,00	0,844	1	25	<b>47,59</b>

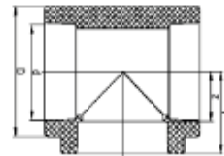

**aquatherm red pipe - Te igual**

Serie	Art.-No.	Diámetro d [mm]	z	l	D	Peso [kg]	Uds / paquete	Uds / caja	€ / Ud
<b>soldadura a enchufe</b>									
3,2 5	3060025012	<b>25</b>	15,00	31,00	34,00	0,033	10	500	<b>1,34</b>
	3060032013	<b>32</b>	17,00	35,00	43,00	0,054	5	300	<b>2,22</b>
	3060040014	<b>40</b>	20,00	40,50	52,00	0,099	5	175	<b>3,18</b>
	3060050004	<b>50</b>	26,00	49,50	68,00	0,175	5	100	<b>9,93</b>
	3060063005	<b>63</b>	32,50	60,00	84,00	0,371	1	50	<b>15,27</b>
	3060075006	<b>75</b>	38,50	68,50	100,00	0,540	1	30	<b>23,86</b>
	3060090007	<b>90</b>	46,00	79,00	120,00	0,924	1	25	<b>44,48</b>
	3060110008	<b>110</b>	56,00	93,00	147,00	1,611	1	14	<b>70,18</b>
	3060125009	<b>125</b>	76,50	116,50	167,00	2,655	1	8	<b>94,36</b>
<b>soldadura a tope</b>									
5	3064160004	<b>160</b>	-	145,00	160	2,791	1	5	<b>125,35</b>

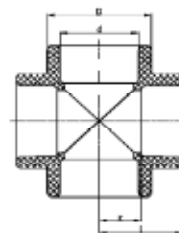

**aquatherm red pipe - Cruz igual**

Serie	Art.-No.	Diámetro d [mm]	z	l	D	Peso [kg]	Uds / paquete	Uds / caja	€ / Ud
3,2	<b>soldadura a enchufe hembra en todos los extremos</b>								
5	3040032000	<b>32</b>	35,00	17,00	43,00	0,064	5	250	<b>3,99</b>
	3040040001	<b>40</b>	41,50	21,00	52,00	0,099	5	150	<b>8,23</b>

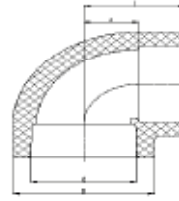

**aquatherm red pipe - Codo 90° H/H**

Serie	Art.-No.	Diámetro d [mm]	z	L	D	Peso [kg]	Uds / paquete	Uds / caja	€ / Ud
<b>soldadura a enchufe</b>									
3,2 5	3080025001	<b>25</b>	13,50	29,50	34,00	0,023	10	800	<b>1,02</b>
	3080032002	<b>32</b>	17,00	35,00	43,00	0,043	5	400	<b>1,68</b>
	3080040003	<b>40</b>	21,00	41,50	52,00	0,071	5	250	<b>2,81</b>
	3080050004	<b>50</b>	26,00	49,50	68,00	0,163	5	125	<b>6,61</b>
	3080063005	<b>63</b>	32,50	60,00	84,00	0,290	1	70	<b>10,11</b>
	3080075006	<b>75</b>	38,50	68,50	100,00	0,446	1	40	<b>21,02</b>
	3080090007	<b>90</b>	46,00	79,00	120,00	0,743	1	25	<b>38,99</b>
	3080110008	<b>110</b>	56,00	93,00	147,00	1,282	1	15	<b>54,58</b>
	3080125009	<b>125</b>	76,50	116,50	167,00	2,006	1	10	<b>85,52</b>
<b>soldadura a tope</b>									
5	3084160002	<b>160</b>	-	145,00	160,00	1,922	1	1	<b>105,67</b>

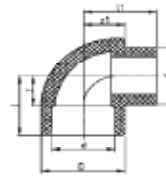

**aquatherm red pipe - Codo 90° M/H**

Serie	Art.-No.	Diámetro d [mm]	z	L	D	L1	z1	Peso [kg]	Uds / paquete	Uds / caja	€ / Ud
<b>soldadura a enchufe - macho hembra</b>											
3,2 5	3080032010	<b>32</b>	17,00	35,00	43,00	39,00	21,50	0,047	5	500	<b>2,81</b>
	3080040011	<b>40</b>	21,00	41,50	52,00	45,50	26,00	0,080	5	300	<b>4,18</b>

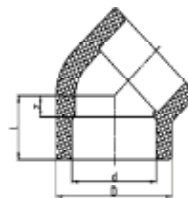

**aquatherm red pipe - Codo 45° H/H**

Serie	Art.-No.	Diámetro d [mm]	z	L	D	Peso [kg]	Uds / paquete	Uds / caja	€ / Ud
<b>soldadura a enchufe</b>									
3,2 5	3080025020	<b>25</b>	6,00	22,00	34,00	0,018	10	1000	<b>1,02</b>
	3080032021	<b>32</b>	7,50	25,50	43,00	0,035	5	500	<b>1,68</b>
	3080040022	<b>40</b>	9,50	30,00	52,00	0,053	5	300	<b>2,81</b>
	3080050023	<b>50</b>	11,50	35,00	68,00	0,113	5	150	<b>6,61</b>
	3080063024	<b>63</b>	14,00	41,50	84,00	0,226	1	75	<b>10,11</b>
	3080075025	<b>75</b>	16,50	46,50	100,00	0,350	1	60	<b>21,02</b>
	3080090026	<b>90</b>	19,50	52,50	120,00	0,571	1	30	<b>38,99</b>
	3080110027	<b>110</b>	23,50	60,50	147,00	1,022	1	20	<b>54,58</b>
	3080125028	<b>125</b>	27,00	67,00	167,00	1,309	1	15	<b>85,52</b>
<b>soldadura a tope</b>									
5	3084160003	<b>160</b>	-	95,00	160,00	1,380	1	10	<b>92,14</b>

**aquatherm red pipe - Codo 45° M/H**



Serie	Art.-No.	Diámetro d [mm]	z	l	D	l1	z1	Peso [kg]	Uds / paquete	Uds / caja	€ / Ud
<b>soldadura a enchufe - macho hembra</b>											
3,2	3080032029	32	7,50	25,50	43,00	28,50	11,50	0,036	5	500	<b>2,81</b>
5	3080040030	40	9,50	30,00	52,00	30,50	13,50	0,057	5	300	<b>4,30</b>

**aquatherm red pipe - Reducción M/H**

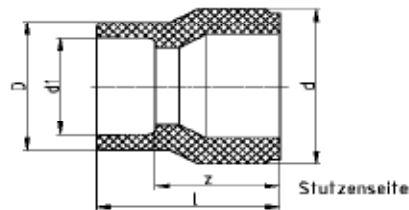

Serie	Art.-No.	Diámetro d [mm] - M	Diámetro d1 [mm] - H	l	z	D	Peso [kg]	Uds / paquete	Uds / caja	€ / Ud
<b>soldadura a enchufe</b>										
3,2 5	3040032030	<b>32</b>	<b>25</b>	38,00	22,00	34,00	0,016	5	1000	<b>1,15</b>
	3040040031	<b>40</b>	<b>32</b>	50,00	32,00	43,00	0,032	5	600	<b>2,16</b>
	3040050032	<b>50</b>	<b>32</b>	54,00	36,00	43,00	0,048	5	350	<b>3,87</b>
	3040050033	<b>50</b>	<b>40</b>	52,50	32,00	52,00	0,053	5	300	<b>3,87</b>
	3040063919	<b>63</b>	<b>40</b>	65,00	44,50	52,00	0,089	1	200	<b>7,95</b>
	3040063034	<b>63</b>	<b>50</b>	63,50	40,00	68,00	0,107	1	150	<b>6,99</b>
	3040075035	<b>75</b>	<b>50</b>	63,00	39,50	68,00	0,141	1	100	<b>8,21</b>
	3040075036	<b>75</b>	<b>63</b>	71,00	43,50	84,00	0,171	1	100	<b>17,65</b>
	3040090037	<b>90</b>	<b>63</b>	78,00	50,50	84,00	0,226	1	75	<b>17,65</b>
	3040090038	<b>90</b>	<b>75</b>	81,50	51,50	100,00	0,272	1	60	<b>17,65</b>
	3040110039	<b>110</b>	<b>63</b>	86,00	58,50	84,00	0,356	1	50	<b>34,31</b>
3040110040	<b>110</b>	<b>90</b>	99,00	66,00	120,00	0,502	1	40	<b>44,91</b>	
3040125041	<b>125</b>	<b>90</b>	99,00	66,00	120,00	0,588	1	35	<b>65,50</b>	
3040125042	<b>125</b>	<b>110</b>	112,00	75,00	147,00	0,833	1	25	<b>68,56</b>	
<b>soldadura a tope</b>										
5	3044160000	<b>160</b>	<b>110</b>	90,00	53,00	147,00	1,024	1	1	<b>84,15</b>
	3044160001	<b>160</b>	<b>125</b>	90,00	50,00	167,00	0,940	1	20	<b>88,64</b>

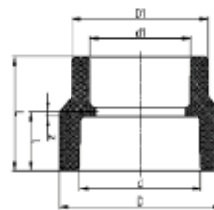

**aquatherm red pipe - Reducción H/H**

Serie	Art.-No.	Diámetro d [mm]	Diámetro d1 [mm]	L	l	z	D	D1	Peso [kg]	Uds / Paquete	Uds / caja	€ / Ud
<b>soldadura a enchufe</b>												
3,2 5	3040063005	<b>63</b>	<b>50</b>	56,00	30,00	2,50	84,00	68,00	0,120	1	100	<b>13,54</b>
	3040075006	<b>75</b>	<b>63</b>	62,50	32,50	2,50	100,00	84,00	0,186	1	80	<b>14,97</b>
	3040090007	<b>90</b>	<b>75</b>	69,00	36,00	3,00	120,00	100,00	0,152	1	50	<b>20,09</b>

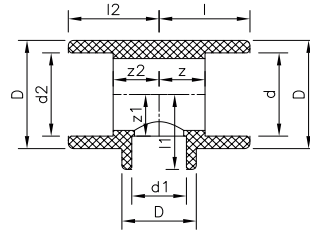

**aquatherm red pipe - Te reducida**

Serie	Art.-No.	d	d1	d2	l	l1	l2	z	z1	z2	D	D1	Peso [kg]	Uds / paquete	Uds / caja	€ / Ud	
<b>soldadura a enchufe</b>																	
3,2	3060040010	<b>40</b>	<b>32</b>	<b>40</b>	42,00	40,50	42,00	21,50	22,50	21,50	52,00	52,00	0,092	5	200	<b>3,49</b>	
	3060050011	<b>50</b>	<b>32</b>	<b>50</b>	49,50	44,50	49,50	26,00	26,50	26,00	68,00	43,00	0,159	5	100	<b>10,04</b>	
	3060050012	<b>50</b>	<b>40</b>	<b>50</b>	49,50	49,50	49,50	26,00	29,00	26,00	68,00	68,00	0,161	5	100	<b>10,04</b>	
	3060063013	<b>63</b>	<b>32</b>	<b>63</b>	60,00	53,50	60,00	32,50	35,50	32,50	84,00	52,00	0,342	1	50	<b>15,65</b>	
	3060063014	<b>63</b>	<b>40</b>	<b>63</b>	60,00	53,50	60,00	32,50	33,00	32,50	84,00	52,00	0,333	1	50	<b>14,72</b>	
	3060063015	<b>63</b>	<b>50</b>	<b>63</b>	60,00	60,00	60,00	32,50	36,50	32,50	84,00	84,00	0,402	1	50	<b>14,72</b>	
	3060075016	<b>75</b>	<b>40</b>	<b>75</b>	68,50	59,00	68,50	38,50	38,50	38,50	100,00	52,00	0,496	1	35	<b>22,64</b>	
	3060075017	<b>75</b>	<b>50</b>	<b>75</b>	68,50	66,00	68,50	38,50	42,50	38,50	100,00	84,00	0,553	1	35	<b>22,64</b>	
	3060075018	<b>75</b>	<b>63</b>	<b>75</b>	68,50	66,00	68,50	38,50	38,50	38,50	100,00	84,00	0,518	1	35	<b>22,64</b>	
	5	3060090019	<b>90</b>	<b>40</b>	<b>90</b>	79,00	65,00	79,00	46,00	44,50	46,00	120,00	52,00	0,870	1	25	<b>45,23</b>
		3060090020	<b>90</b>	<b>50</b>	<b>90</b>	79,00	75,00	79,00	46,00	51,50	46,00	120,00	84,00	0,908	1	25	<b>45,23</b>
		3060090021	<b>90</b>	<b>63</b>	<b>90</b>	79,00	75,00	79,00	46,00	47,50	46,00	120,00	84,00	0,874	1	25	<b>45,23</b>
		3060090022	<b>90</b>	<b>75</b>	<b>90</b>	79,00	81,00	79,00	46,00	51,00	46,00	120,00	120,00	0,993	1	25	<b>45,23</b>
		3060110023	<b>110</b>	<b>63</b>	<b>110</b>	93,00	87,50	93,00	56,00	60,00	56,00	147,00	100,00	1,567	1	15	<b>70,18</b>
		3060110024	<b>110</b>	<b>75</b>	<b>110</b>	93,00	87,50	93,00	56,00	57,50	56,00	147,00	100,00	1,501	1	15	<b>70,18</b>
		3060110025	<b>110</b>	<b>90</b>	<b>110</b>	93,00	89,00	93,00	56,00	56,00	56,00	147,00	120,00	1,534	1	15	<b>70,18</b>
		3060125026	<b>125</b>	<b>75</b>	<b>125</b>	116,50	106,50	116,50	76,50	76,50	76,50	167,00	100,00	2,421	1	8	<b>99,00</b>
		3060125027	<b>125</b>	<b>90</b>	<b>125</b>	116,50	109,50	116,50	76,50	76,50	76,50	167,00	120,00	2,519	1	8	<b>99,00</b>
3060125028		<b>125</b>	<b>110</b>	<b>125</b>	116,50	113,50	116,50	76,50	76,50	76,50	167,00	147,00	2,563	1	8	<b>99,00</b>	
<b>soldadura a tope</b>																	
5	3064160005	<b>160</b>	<b>75</b>	<b>160</b>	230,00	-	-	92,00	-	-	100,00	-	3,140	1	4	<b>157,26</b>	
	3064160006	<b>160</b>	<b>90</b>	<b>160</b>	230,00	-	-	92,00	-	-	120,00	-	3,180	1	4	<b>163,87</b>	

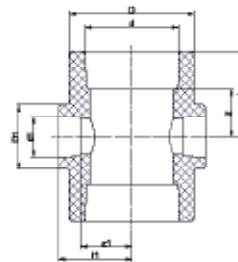

**aquatherm red pipe - Cruz reducida**

Serie	Art.-No.	Dimensión	d1	z1	D1	l1	d	z	D	l	Peso [kg]	Uds / paquete	Uds / caja	€ / Ud
<b>soldadura a enchufe</b>														
3,2	3040050010	<b>50 / 32 mm</b>	32,00	26,50	43,00	44,50	50,00	26,00	68,00	45,50	0,170	1	100	<b>23,14</b>
	3040063011	<b>63 / 32 mm</b>	32,00	35,50	52,00	53,50	63,00	32,50	84,00	60,00	0,323	1	10	<b>24,77</b>
	3040063012	<b>63 / 40 mm</b>	40,00	33,00	52,00	53,50	63,00	32,50	84,00	60,00	0,302	1	12	<b>26,57</b>
	3040075013	<b>75 / 32 mm</b>	32,00	41,00	52,00	59,00	75,00	38,50	100,00	68,50	0,505	1	30	<b>27,39</b>
	3040075014	<b>75 / 40 mm</b>	40,00	42,50	68,00	66,00	75,00	38,50	100,00	68,50	0,483	1	30	<b>32,01</b>
	3040075015	<b>75 / 50 mm</b>	50,00	51,50	68,00	66,00	75,00	38,50	100,00	68,50	0,483	1	30	<b>42,86</b>
5	3040090016	<b>90 / 50 mm</b>	50,00	51,50	68,00	75,00	90,00	35,50	120,00	68,50	0,703	1	5	<b>49,22</b>

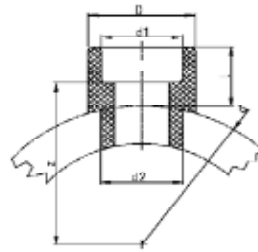

**aquatherm red pipe - Derivación en asiento**

Serie	Art.-No.	d	d1	d2	l	z	D	Peso [kg]	Uds / paquete	Uds / caja	€ / Ud
<b>soldadura a enchufe - necesaria matrices y brocas para derivaciones (pag. 17)</b>											
3,2 5	3030063001	<b>63</b>	<b>32</b>	32	30,00	43,50	43,00	0,028	5	750	<b>3,12</b>
	3030075002	<b>75</b>	<b>32</b>	32	30,00	49,50	43,00	0,028	5	750	<b>3,12</b>
	3030075003	<b>75</b>	<b>40</b>	40	34,00	51,00	52,00	0,049	5	400	<b>3,12</b>
	3030090004	<b>90</b>	<b>32</b>	32	30,00	57,00	43,00	0,029	5	750	<b>3,12</b>
	3030090005	<b>90</b>	<b>40</b>	40	34,00	58,50	52,00	0,048	5	500	<b>3,12</b>
	3030110006	<b>110</b>	<b>32</b>	32	30,00	67,00	43,00	0,030	5	750	<b>3,12</b>
	3030110007	<b>110</b>	<b>40</b>	40	34,00	68,50	52,00	0,050	5	450	<b>3,12</b>
	3030110008	<b>110</b>	<b>50</b>	50	34,00	65,50	68,00	0,091	5	200	<b>4,74</b>
	3030125009	<b>125</b>	<b>32</b>	32	30,00	74,50	43,00	0,029	5	750	<b>3,12</b>
	3030125010	<b>125</b>	<b>40</b>	40	34,00	76,00	52,00	0,050	5	450	<b>3,12</b>
	3030125011	<b>125</b>	<b>50</b>	50	34,00	73,00	68,00	0,091	5	200	<b>4,74</b>
3030125012	<b>125</b>	<b>63</b>	63	38,00	73,00	84,00	0,150	5	125	<b>6,42</b>	
5	3030160000	<b>160</b>	<b>32</b>	32	30,00	92,00	43,00	0,034	5	300	<b>5,64</b>
	3030160001	<b>160</b>	<b>40</b>	40	34,00	93,50	52,00	0,054	5	200	<b>6,21</b>
	3030160002	<b>160</b>	<b>63</b>	63	38,00	90,50	84,00	0,155	5	120	<b>12,40</b>

Con asiento soldable y empotramiento adicional para la fusión con el tubo  
 Para matrices de soldar derivaciones en asiento **aquatherm red pipe**-véase pág. 21  
 -Matrices  
 Art.-No. 50614 - 50644  
 -Brocas  
 Art.-No. 50940 - 50948

**TAPÓN DE REPARACIÓN**

para reparación de tuberías

Art.-No.	Dimensión	Uds./Paquete	Uds./Caja	Precio € m/pc
<b>3090000012</b>	7/11 mm	10		<b>2,62</b>



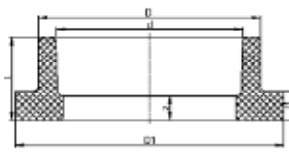

### aquatherm red pipe - Portabridas con junta plana

Serie	Art.-No.	Diámetro d [mm]	l	z	D	D1	l1	z1	Peso [kg]	Uds / paquete	Uds / caja	€/ Ud
soldadura a enchufe												
3,2	3050032001	<b>32</b>	35,00	17,00	41,00	68,00	11,00	3,00	0,053	1	300	<b>6,11</b>
	3050040002	<b>40</b>	36,50	16,50	50,00	78,00	12,50	3,00	0,071	1	250	<b>8,48</b>
	3050050003	<b>50</b>	39,50	16,00	61,00	88,00	12,00	3,00	0,095	1	200	<b>12,85</b>
	3050063004	<b>63</b>	43,50	16,00	76,00	102,00	15,50	3,00	0,130	1	200	<b>15,59</b>
	3050075005	<b>75</b>	46,00	16,00	90,00	122,00	16,00	3,00	0,191	1	100	<b>18,03</b>
	3050090006	<b>90</b>	50,00	17,00	108,00	138,00	17,00	3,00	0,258	1	60	<b>24,08</b>
	3050110007	<b>110</b>	55,50	18,50	131,00	158,00	18,50	3,00	0,329	1	50	<b>36,80</b>
3050125008	<b>125</b>	63,00	23,00	165,00	188,00	20,00	3,00	0,724	1	10	<b>42,86</b>	
soldadura a tope												
5	3054160009	<b>160</b>	25,00	93,00	175,00	212,00	14,60	53,00	0,955	1	1	<b>60,64</b>

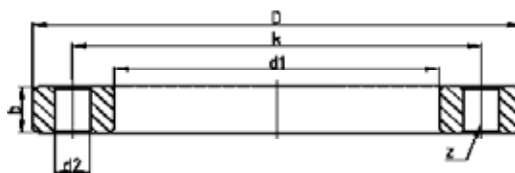

### aquatherm red pipe - Brida loca de acero - (DIN 2602)

Serie	Art.-No.	Dimensión (portabridas)	Dimensión brida	Adaptable a Art.-No.	d1	D	K	d2	b	z	Peso [kg]	Uds / caja	€/ Ud
necesita de portabridas con junta plana													
3,2	9604114200	<b>32</b>	<b>1"</b>	4115512	42,00	116,00	85,00	14,00	15,50	4,00	0,466	1	<b>49,22</b>
	9604114201	<b>40</b>	<b>1 1/4"</b>	4115514	51,00	141,00	100,00	18,00	17,50	4,00	0,681	1	<b>61,63</b>
	9604114202	<b>50</b>	<b>1 1/2"</b>	4115516	62,00	151,00	110,00	18,00	17,50	4,00	0,767	1	<b>92,07</b>
	9604114206	<b>63</b>	<b>2"</b>	4115518	78,00	166,00	125,00	18,00	19,00	4,00	0,885	1	<b>106,11</b>
	9604114207	<b>75</b>	<b>2 1/2"</b>	4115520	92,00	186,00	145,00	18,00	19,00	4,00	1,154	1	<b>127,13</b>
	9604114208	<b>90</b>	<b>3"</b>	4115522	110,00	201,00	160,00	18,00	21,00	8,00	1,404	1	<b>129,69</b>
	9604114212	<b>110</b>	<b>4"</b>	4115524	133,00	221,00	180,00	18,00	22,00	8,00	1,461	1	<b>148,15</b>
	9604114213	<b>125</b>	<b>5"</b>	4115527	167,00	251,00	210,00	18,00	26,00	8,00	2,096	1	<b>216,27</b>
9604115730	<b>160</b>	<b>6"</b>	4115531	178,00	286,00	240,00	22,00	27,00	8,00	3,628	1	<b>294,94</b>	

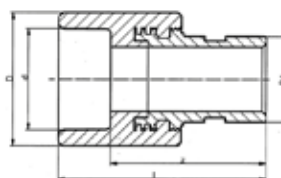

### aquatherm red pipe - Pieza de transición con ranura de acoplamiento

Serie	Art.-No.	Dimensiones	d	l	z	D	D1	Peso [kg]	Uds / paquete	Uds / caja	€/ Ud
soldadura a enchufe - para acoplamiento desmontable											
3,2	3070040010	<b>40mm x 1"</b>	40,00	81,00	60,50	52,00	33,50	0,226	1	20	<b>36,99</b>
	3070050011	<b>50mm x 1 1/4"</b>	50,00	85,50	62,00	68,00	42,50	0,373	1	15	<b>42,36</b>
	3070063012	<b>63mm x 1 1/2"</b>	63,00	97,50	70,00	84,00	48,25	0,533	1	8	<b>56,08</b>
	3070075013	<b>75mm x 2"</b>	75,00	97,00	67,00	100,00	60,30	0,788	1	6	<b>83,72</b>
5	3070090014	<b>90mm x 3"</b>	90,00	110,00	77,00	120,00	88,90	1,315	1	4	<b>261,00</b>
	3070110015	<b>110mm x 4"</b>	110,00	119,50	82,50	147,00	114,30	2,117	1	2	<b>357,51</b>
	3070125016	<b>125mm x 5"</b>	125,00	167,00	130,00	167,00	140,00	5,270	1	5	<b>453,95</b>

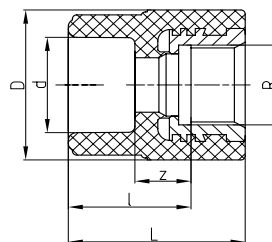

### aquatherm red pipe - Entronque recto RH

con cuello estriado.

Serie	Art.-No.	d	R	l	z	D	L	Peso [kg]	Uds / paquete	Uds / caja	€ / Ud
soldadura a enchufe											
3,2 5	3070025020	25	1/2"	29,50	13,50	34,00	42,50	0,065	10	400	4,87
	3070025021	25	3/4"	27,50	11,50	34,00	40,50	0,087	10	300	7,42
	3070032022	32	3/4"	30,50	12,50	43,00	43,50	0,092	5	200	7,55
	3070032023	32	1/2"	28,00	10,00	43,00	41,00	0,081	5	300	8,55
	3070040024	40	1/2"	32,50	12,00	52,00	45,50	0,087	5	50	10,60
	3070040025	40	3/4"	33,00	12,50	52,00	46,00	0,105	5	200	11,35

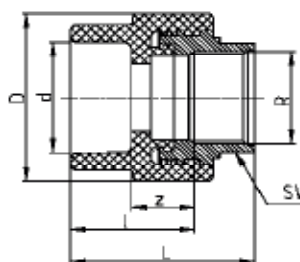

### aquatherm red pipe - Entronque recto RH

con cuello hexagonal

Serie	Art.-No.	d	R	l	z	D	L	SW	Peso [kg]	Uds / paquete	Uds / caja	€ / Ud
soldadura a enchufe												
3,2 5	3070032026	32	3/4"	30,00	12,00	43,50	53,00	31	0,114	5	150	9,54
	3070032027	32	1"	37,50	19,50	60,00	59,50	39	0,239	5	150	18,45
	3070040028	40	1"	40,00	19,50	60,00	62,00	39	0,245	5	125	21,25
	3070040029	40	1 1/4"	42,00	21,50	74,00	65,00	50	0,385	5	80	33,66
	3070050030	50	1 1/4"	45,00	21,50	74,00	68,00	50	0,404	5	75	36,71
	3070050031	50	1 1/2"	45,00	21,50	85,50	67,00	55	0,424	5	60	40,34
	3070063032	63	1 1/2"	51,50	24,00	84,00	73,50	55	0,440	1	50	43,52
	3070063033	63	2"	50,00	22,50	101,00	76,00	67	0,589	1	35	61,91
	3070075034	75	2"	51,00	21,00	100,00	77,00	67	0,613	1	25	63,95
	3070032035	32	1/2"	37,00	19,00	43,00	53,00	24	0,091	1	150	10,12
	3070040036	40	1/2"	38,00	17,50	52,00	55,50	24	0,101	1	150	16,48



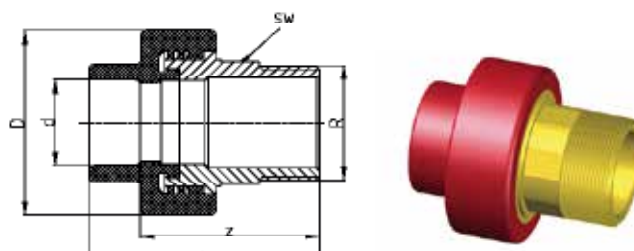

**aquatherm red pipe - Entronque recto RM**  
con cuello hexagonal.

Serie	Art.-No.	d	R	l	z	D	Peso [kg]	Uds / paquete	Uds / caja	€ / Ud
<b>Soldadura a enchufe</b>										
3,2 5	3070032037	<b>32</b>	<b>3/4"</b>	70,00	52,00	43,00	0,117	5	40	<b>12,53</b>
	3070032038	<b>32</b>	<b>1"</b>	78,50	60,50	53,00	0,216	5	100	<b>17,59</b>
	3070032039	<b>32</b>	<b>1 1/4"</b>	81,00	63,00	68,00	0,320	5	100	<b>31,88</b>
	3070040040	<b>40</b>	<b>1"</b>	81,00	60,50	52,00	0,222	5	100	<b>19,53</b>
	3070040041	<b>40</b>	<b>1 1/4"</b>	84,50	64,00	68,00	0,326	5	80	<b>33,00</b>
	3070050042	<b>50</b>	<b>1 1/4"</b>	85,50	62,00	68,00	0,352	5	75	<b>35,87</b>
	3070050043	<b>50</b>	<b>1 1/2"</b>	88,50	65,00	74,00	0,429	5	60	<b>43,23</b>
	3070063044	<b>63</b>	<b>1 1/2"</b>	99,00	71,50	72,50	0,466	1	40	<b>50,78</b>
	3070063045	<b>63</b>	<b>2"</b>	102,50	75,00	84,00	0,679	1	40	<b>58,51</b>
	3070075046	<b>75</b>	<b>2"</b>	104,00	74,00	84,00	0,729	1	25	<b>63,32</b>
	3070075047	<b>75</b>	<b>2 1/2"</b>	105,00	75,00	100,00	0,972	1	25	<b>84,78</b>
	3070090048	<b>90</b>	<b>3"</b>	126,00	93,00	120,00	1,315	1	20	<b>131,81</b>
3070110049	<b>110</b>	<b>4"</b>	148,00	111,00	147,00	2,699	1	8	<b>249,59</b>	

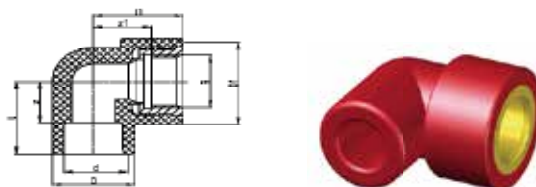

**aquatherm red pipe - Entronque codo 90° RH/H**

Serie	Art.-No.	d	R	l	z	D	l1	z1	D1	Peso [kg]	Uds / paquete	Uds / caja	€ / Ud
<b>soldadura a enchufe</b>													
3,2 5	3070032001	<b>32</b>	<b>1/2"</b>	27,50	9,50	43,00	51,00	38,00	49,50	0,104	5	40	<b>8,48</b>
	3070032003	<b>32</b>	<b>3/4"</b>	34,00	16,00	43,00	66,50	44,00	60,50	0,251	5	100	<b>9,86</b>
	3070032004	<b>32</b>	<b>1"</b>	34,00	16,00	43,00	66,50	44,00	60,50	0,251	5	100	<b>20,84</b>
	3070040004	<b>40</b>	<b>1/2"</b>	41,00	20,50	52,00	39,00	26,00	37,00	0,127	5	30	<b>11,35</b>
	3070040005	<b>40</b>	<b>1"</b>	41,50	21,00	52,00	56,00	34,00	60,00	0,274	5	75	<b>28,57</b>

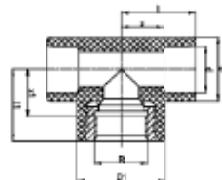
**aquatherm red pipe - Te de transición RH**

Serie	Art.-No.	d	R	l	z	D	l1	z1	D1	Peso [kg]	Uds / paquete	Uds / caja	€ / Ud
<b>soldadura a enchufe</b>													
3,2 5	3060025030	<b>25</b>	<b>1/2"</b>	34,00	18,00	34,00	38,00	25,00	37,00	0,088	10	200	<b>6,99</b>
	3060032031	<b>32</b>	<b>1/2"</b>	35,00	17,00	37,00	37,00	24,00	37,00	0,113	5	125	<b>9,54</b>
	3060032032	<b>32</b>	<b>3/4"</b>	27,50	9,50	43,00	51,00	38,00	44,00	0,118	5	100	<b>10,92</b>
	3060032033	<b>32</b>	<b>1"</b>	31,00	13,50	43,00	67,00	49,00	60,00	0,274	5	80	<b>21,08</b>
	3060040034	<b>40</b>	<b>1/2"</b>	39,00	26,00	52,00	42,50	22,00	37,00	0,113	5	100	<b>10,85</b>
	3060040035	<b>40</b>	<b>3/4"</b>	40,00	20,00	52,00	40,50	27,50	37,00	0,157	5	100	<b>22,02</b>
	3060040036	<b>40</b>	<b>1"</b>	41,00	21,00	52,00	56,00	34,00	60,00	0,279	5	75	<b>27,70</b>
	3060050037	<b>50</b>	<b>1"</b>	49,50	26,00	68,00	63,50	43,50	68,00	0,387	5	40	<b>31,19</b>
	3060050038	<b>50</b>	<b>1 1/4"</b>	49,50	26,00	68,00	65,00	45,00	68,00	0,478	5	5	<b>40,49</b>
	3060050040	<b>50</b>	<b>1/2"</b>	49,50	26,00	68,00	44,50	31,50	43,00	0,237	5	50	<b>25,64</b>
3060050041	<b>50</b>	<b>3/4"</b>	49,50	26,00	68,00	44,50	31,50	43,00	0,243	5	50	<b>26,45</b>	

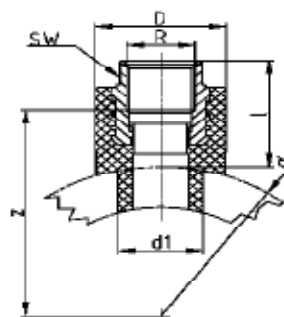
**aquatherm red pipe - Derivación en asiento mixta RH**

Serie	Art.-No.	d	d1	R	l	z	D	SW	Peso [kg]	Uds / paquete	Uds / caja	€ / Ud
<b>soldadura a enchufe - necesaria matrices y brocas para derivaciones (pag. 17)</b>												
3,2 5	3030040021	<b>40</b>	25	<b>1/2"</b>	39,00	41,00	38,50	24,00	0,088	5	300	<b>10,11</b>
	3030050022	<b>50</b>	25	<b>1/2"</b>	39,00	46,00	38,50	24,00	0,090	5	300	<b>10,11</b>
	3030075023	<b>75</b>	32	<b>1"</b>	43,00	58,50	60,00	39,00	0,222	5	125	<b>20,27</b>
	3030090024	<b>90</b>	32	<b>1"</b>	43,00	66,00	60,00	39,00	0,221	5	125	<b>36,87</b>
	3030110025	<b>110</b>	32	<b>1"</b>	43,00	76,00	60,00	39,00	0,224	5	125	<b>21,58</b>
	3030125026	<b>125</b>	32	<b>1"</b>	43,00	83,50	60,00	39,00	0,022	5	125	<b>21,83</b>

Con asiento soldable y empotramiento adicional para la fusión con el tubo

Para matrices de soldar derivaciones en asiento **aquatherm red pipe**-véase pág. 17

-Matrices

Art.-No. 50614 - 50644

-Brocas

Art.-No. 50940 - 50948

# HERRAMIENTAS



**PRISMA JIG: ÚTIL DE APROXIMACIÓN**

Art.-No.	Dimensiones admitidas	Uds./Paquete	Uds./Caja	Precio € m/pc
94650087	∅ 25 - 125 mm	1		4.581,26

incluye maletín, juego de mordazas y herramienta para su cambio



**EQUIPO LIGERO DE SOLDADURA (1400 W)**

Art.-No.	Dimensiones admitidas	Uds./Paquete	Uds./Caja	Precio € m/pc
95500004	∅ 63 - 125 mm	1		9.124,34

Sin matrices 63 a 125, con caja de madera para el transporte.



**BANCO DE TRABAJO PRISMA 125**

Art.-No.	Dimensiones admitidas	Uds./Paquete	Uds./Caja	Precio € m/pc
94600501	∅ 25 - 125 mm	1		15.461,75

Incluye matrices de 25 a 125 y carro de transporte



**EQUIPO DE SOLDAR A TOPE - RITMO**

Art.-No.	Dimensiones admitidas	Uds./Paquete	Uds./Caja	Precio € m/pc
90950542	∅ 160	1		12.980,24
93100007	∅ 160 - 200 mm	1		15.016,35
91070516	∅ 160 - 250 mm	1		17.306,98
91165533	∅ 160 - 315 mm	1		21.506,47
93400100	∅ 160 - 355 mm	1		26.087,73
91350600***	∅ 160 - 630 mm	1		59.047,36

el equipo de soldadura a tope se puede pedir a Ritmo ([www.ritmo.it/es](http://www.ritmo.it/es))  
 Todas la máquinas incluyen el juego de reducciones para tuberías de PP-R  
 \* También disponible para 400 V trifásica  
 \*\* Disponible bajo demanda grúa eléctrica para la ayuda de la introducción de la plancha y el refrentador y carro de transporte.



**EQUIPO DE SOLDAR A TOPE - DOS ANILLOS-RITMO**

Art.-No.	Dimensiones admitidas	Uds./Paquete	Uds./Caja	Precio € m/pc
93650000	∅ 160 - 355 mm	1		25.826,86

el equipo de soldadura a tope se puede pedir a Ritmo ([www.ritmo.it/es](http://www.ritmo.it/es))  
 \*También disponible para 110 V



**SOLDADOR CON TRÍPODE Y MALETA (500 W)**

Art.-No.	Dimensiones admitidas	Uds./Paquete	Uds./Caja	Precio € m/pc
<b>9800050336</b>	ø 16 - 32 mm	1		<b>495,68</b>

sin matrices

**SOLDADOR CON TRÍPODE Y MALETA (800 W)**

Art.-No.	Dimensiones admitidas	Uds./Paquete	Uds./Caja	Precio € m/pc
<b>9800050337</b>	ø 16 - 63 mm	1		<b>636,29</b>

también disponible en 110V 65 Hz  
sin matrices**SOLDADOR CON TRÍPODE Y MALETA (1400 W)**

Art.-No.	for pipe Dimensiones	PU	Uds./Caja	Precio € m/pc
<b>9800050341</b>	ø 50 - 125 mm	1		<b>1.234,40</b>

también disponible en 110V 65 Hz  
sin matrices**EQUIPO DE SOLDAR - ELECTROFUSIÓN**

Art.-No.	Dimensiones admitidas	Uds./Paquete	Uds./Caja	Precio € m/pc
<b>9800050175</b>	ø 20 - 250 mm	1		<b>8.271,72</b>

Para accesorios de electrofusión Art.-No. 17234-17238.  
Se requieren herramientas de calibración, bajo pedido.**SOLDADOR EN BANCO DE TRABAJO (1400 W)**

Art.-No.	Dimensiones admitidas	Uds./Paquete	Uds./Caja	Precio € m/pc
<b>9800050148</b>	ø 50 - 125 mm - 230 V	1		<b>16.308,02</b>

incluye matrices de 50 a 125 y caja de transporte de madera.

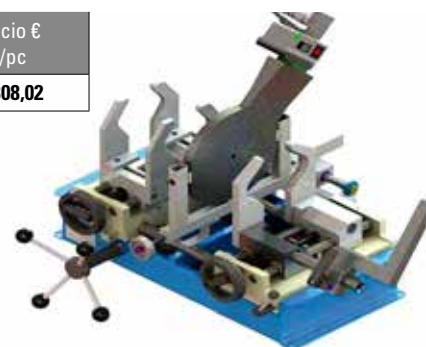
**PLANCHA DE SOLDADURA MANUAL - PARA SOLDADURA A TOPE (1500 W) Ø 50-160 mm**

Art.-No.	Dimensiones admitidas	Uds./Paquete	Uds./Caja	Precio € m/pc
<b>9800050330</b>	Ø 50 - 160 mm	1		<b>4.523,37</b>



**EQUIPO PARA SOLDADAR A TOPE - ROTHENBERGER**

Art.-No.	Dimensiones admitidas	Uds./Paquete	Uds./Caja	Precio € m/pc
50163	∅ 160 - 250 mm	1		24.719,72
50178	∅ 160 - 355 mm	1		27.742,08
50179	∅ 160 - 500 mm	1		71.741,27

incluye caja de madera para el transporte.  
 el equipo de soldadura a tope se puede pedir a Rothenberger ([www.rothenberger.com](http://www.rothenberger.com))



**UTIL ELÉCTRICO DE APROXIMACIÓN**

Art.-No.	Dimensiones admitidas	Uds./Paquete	Uds./Caja	Precio € m/pc
9800050161	∅ 63 - 125 mm	1		10.040,60

incluye batería, cargador y maletín



**SOPORTE PARA ART.-NO. 50159**

Art.-No.	Dimensión	Uds./Paquete	Uds./Caja	Precio € m/pc
9800050151		1		719,00



**MATRIZ PARA SOLDAR DERIVACIONES EN CARGA**

Para usar con las derivaciones en carga

Art.-No.	Dimensión	Uds./Paquete	Uds./Caja	Precio € m/pc
9800050760	75x40mm para 50890	1		349,33
9800050761	90x40mm para 50890	1		349,33
9800050762	110x40mm para 50890	1		349,33
9800050763	125x40mm para 50890	1		349,33
9800050764	125x63mm para 50890	1		687,19
9800050765	160x40mm para 50890	1		496,30
9800050766	160x63mm para 50890	1		909,89
9800050767	200x40mm para 50890	1		579,02
9800050768	200x63mm para 50890	1		909,89
9800050769	250x40mm para 50890	1		579,02
9800050770	250x63mm para 50890	1		909,89
9800050771	315x63mm para 50890	1		1.787,96
9800050772	355x63mm para 50890	1		1.832,50
9800050773	400-630x63mm para 50890	1		2.125,20



**MATRIZ PARA SOLDAR DERIVACIONES**

para soldaduras en asiento

Art.-No.	Dimensión	Uds./Paquete	Uds./Caja	Precio € m/pc
9800050614	40 x 20/25 mm	1	40	221,76
9800050616	50 x 20/25 mm	1	35	221,76
9800050619	63 x 20/25 mm	1	35	221,76
9800050620	63 x 32 mm	1	35	221,76
9800050623	75 x 20/25 mm	1	30	221,76
9800050624	75 x 32 mm	1	30	221,76
9800050625	75 x 40 mm	1	20	221,76
9800050627	90 x 20/25 mm	1	30	221,76
9800050628	90 x 32 mm	1	30	221,76
9800050629	90 x 40 mm	1	20	221,76
9800050631	110 x 20/25 mm	1	30	221,76
9800050632	110 x 32 mm	1	30	221,76
9800050634	110 x 40 mm	1	20	221,76
9800050635	110 x 50 mm	1	12	273,91
9800050636	125 x 20/25 mm	1	30	221,76
9800050638	125 x 32 mm	1	30	221,76
9800050640	125 x 40 mm	1	20	221,76
9800050642	125 x 50 mm	1	12	339,10
9800050644	125 x 63 mm	1	6	391,32
9800050648	160 x 20/25 mm	1	20	224,38
9800050650	160 x 32 mm	1	20	224,38
9800050652	160 x 40 mm	1	15	306,54
9800050654	160 x 50 mm	1	10	482,64
9800050656	160 x 63 mm	1	8	554,38
9800050660	200 x 20/25 mm	1	35	345,65
9800050662	200 x 32 mm	1	35	345,65
9800050664	200 x 40 mm	1	20	436,98
9800050666	200 x 50 mm	1	12	560,87
9800050668	200 x 63 mm	1	8	678,27
9800050672	250 x 20/25 mm	1	35	365,24
9800050674	250 x 32 mm	1	35	378,27
9800050676	250 x 40 mm	1	20	417,39
9800050678	250 x 50 mm	1	12	567,42
9800050680	250 x 63 mm	1	8	710,89
9800050690	315 x 63 mm	1	10	1.011,70
9800050712	355 x 63 mm	1	5	1.037,15
9800050726	400-630 x 63 mm	1	5	1.253,48

**MATRIZ CILÍNDRICA PARA SOLDAR**

Art.-No.	Dimensión	Uds./Paquete	Uds./Caja	Precio € m/pc
9800050206	16 mm	1	100	83,03
9800050208	20 mm	1	100	86,27
9800050210	25 mm	1	100	92,33
9800050212	32 mm	1	80	101,12
9800050214	40 mm	1	50	136,30
9800050216	50 mm	1	40	153,08
9800050218	63 mm	1	25	165,18
9800050220	75 mm	1	20	193,94
9800050222	90 mm	1	15	208,73
9800050224	110 mm	1	10	410,90
9800050226	125 mm	1	6	534,79



**CORTATUBOS - DE TIJERA**

Art.-No.	Dimensiones admitidas	Uds./Paquete	Uds./Caja	Precio € m/pc
9800050103	ø 16 - 25 mm	1	10	52,21
9800050104	ø 16 - 40 mm	1	30	150,15
9800050107	ø 50 - 63 mm	1	30	604,47



**CORTATUBOS REMS - DE ARCO**

Art.-No.	Dimensiones admitidas	Uds./Paquete	Uds./Caja	Precio € m/pc
290000	ø 10 - 63 mm	1		273,60
290100	ø 50 - 110 mm	1		393,00
290200	ø 110 - 160 mm	1		483,58
290316	Recambio cuchilla ø 50-315	1		78,29



**SIERRA CIRCULAR ROTATIVA Y ACCESORIOS REMS**

Art.-No.	Dimensiones admitidas	Uds./Paquete	Uds./Caja	Precio € m/pc
845004	ø 40 - 200 mm	1		5.351,17
845057	Recambio disco de corte para plástico	1		248,15



**SIERRA DE SABLE ELECTROPORTÁTIL Y ACCESORIOS REMS**

Art.-No.	Descripción	Enganche	Uds./Paquete	Uds./Caja	Precio € m/pc
560026	Sierra de sable electroportátil		1		1.501,64
563100	Guía para corte recto hasta ø 90		1		407,22
563200	Guía para corte recto hasta ø 125		1		458,13
561111	Hoja de sierra 300-4,2		5		50,28
561117	Hoja sierra 225-3,2/5,0 flexible		5		63,63



Aplicaciones: Para corte en ángulo y recto  
Corte de tuberías de grandes dimensiones

**BROCA PARA DERIVACIONES**

para derivaciones en asiento

Art.-No.	Dimensión	Uds./Paquete	Uds./Caja	Precio € m/pc
9800050940	20 & 25 mm (para tuberías 40 - 160 mm)	1	50	150,03
9800050941	20 & 25 mm (para tuberías 63 - 250 mm)	1	50	163,06
9800050942	32 mm	1	45	169,55
9800050944	40 mm	1	40	195,69
9800050946	50 mm	1	25	384,83
9800050948	63 mm	1	15	495,68



**BROCA PARA ABOCARDAR TUBERÍA aquatherm blue pipe ot ø 50-125mm**

Art.-No.	Dimensión	Uds./Paquete	Uds./Caja	Precio € m/pc
9800050921	Derivaciones de 20 & 25 mm	1	25	489,94
9800050922	Derivaciones de ø 32 mm	1	25	502,67
9800050924	Derivaciones de ø 40 mm	1	20	508,71
9800050926	Derivaciones de ø 50 mm	1	15	521,75
9800050928	Derivaciones de ø 63 mm	1	10	540,84



**BROCA PARA ABOCARDAR TUBERÍA aquatherm blue pipe ot ø 160-250mm**

Art.-No.	Dimensión	Uds./Paquete	Uds./Caja	Precio € m/pc
9800050421	Derivaciones de 20 & 25 mm	1	25	378,27
9800050422	Derivaciones de ø 32 mm	1	25	375,41
9800050424	Derivaciones de ø 40 mm	1	20	391,50
9800050426	Derivaciones de ø 50 mm	1	15	398,24
9800050428	Derivaciones de ø 63 mm	1	10	413,59

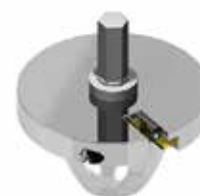



**HERRAMIENTA ACHAFLANAR aquatherm blue pipe OT**

Art.-No.	Dimensión	Uds./Paquete	Uds./Caja	Precio € m/pc
9800050510		1		534,80

Para retirar la barrera de oxígeno antes de la soldadura a tope.

**TIZA PIROMÉTRICA**

Art.-No.	Dimensión	Uds./Paquete	Uds./Caja	Precio € m/pc
9800050190		1		45,69

para comprobar la correcta temperatura de soldadura

**TERMÓMETRO DE CONTACTO**

Art.-No.	Dimensión	Uds./Paquete	Uds./Caja	Precio € m/pc
9800050188		1		617,20

para comprobar la correcta temperatura de soldadura

**GUANTES DE PROTECCIÓN TÉRMICA**

para cambio de matrices en caliente

Art.-No.	Dimensión	Uds./Paquete	Uds./Caja	Precio € m/pc
9800050195		2		15,65

**PAÑOS DE LIMPIEZA**

Art.-No.	Dimensión	Uds./Paquete	Uds./Caja	Precio € m/pc
9800050193	Caja de 100 toallitas	1		45,69

para manguitos de electrofusión

**KIT DE REPARACIÓN DE TALADROS**

Art.-No.	Dimensión	Uds./Paquete	Uds./Caja	Precio € m/pc
9800050307	7 mm	1		124,08
9800050311	11 mm	1		124,08

Para reparar agujeros de hasta 10mm en tuberías (es necesario un tapón de reparación Art.-No. 60600)

**TAPÓN DE REPARACIÓN**

para reparación de tuberías

Art.-No.	Dimensión	Uds./Paquete	Uds./Caja	Precio € m/pc
1090000035	7/11 mm	10		2,35

**CINTA ADHESIVA PROTECTORA CONTRA RADIACIÓN UV PARA ACCESORIOS**

para tuberías aquatherm MF UV

Art.-No.	Dimensión	Uds./Paquete	Precio € m/pc
9700010871	Ancho: 50mm Longitud: 10m	10m/pckg	42,38

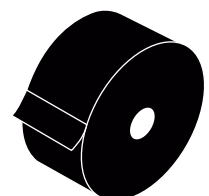

**NUEVO PELADORES UNIVERSALES aquatherm**

apto para:

aquatherm green pipe MF UV  
aquatherm green pipe MF RP UV

aquatherm green pipe MS  
aquatherm blue pipe MF UV



Necesarios para **Soldadura a enchufe**

(en combinación con los accesorios de soldadura a enchufe de la página 18 en adelante, p.e. manguitos, codos , Ts, piezas de transición)

Aptos tambien para pelar el tubo manualmente (tornillos incluidos)

Art.-No.	Dimensión	Uds./Paquete	Uds./Caja	Precio € m/pc
9800050479	20 mm	1		318,14
9800050480	25 mm	1		330,87
9800050481	32 mm	1		356,32
9800050482	40 mm	1		369,05
9800050483	50 mm	1		388,13
9800050484	63 mm	1		432,67
9800050485	75 mm	1		464,49
9800050486	90 mm	1		477,21
9800050487	110 mm	1		566,29
9800050488	125 mm	1		604,47



incl. tornillos para pelado manual

No apto para aquatherm green pipe S, aquatherm blue pipe S, aquatherm green pipe MF, aquatherm blue pipe MF, aquatherm green pipe MF RP, aquatherm green pipe TI, aquatherm blue pipe TI

**S** = individual, **MF** = multicapa faser, **MS** = multicapa stabi, **OT** = barrera de oxígeno, **UV** = protección ultravioleta, **TI** = aislamiento térmico, **RP** = presión aumentada

**aquatherm EXTENSIÓN PARA PELADORES UNIVERSALES**

Necesarios para la **Soldadura a enchufe por electrofusión**  
(accesorios aquatherm electrofusión en página 40)

Cuando se requiere una rofundidad de pelado mayor para la soldadura por electrofusión se consigue mediante la combinación del pelador universal y la extensión para peladores universales (pe. art.-no. 50479+50489)

Art.-No.	Dimensión	Uds./Paquete	Uds./Caja	Precio € m/pc
9800050489	para pelador 20 mm art.-no. 50479	1		94,51
9800050490	para pelador 25 mm art.-no. 50480	1		94,51
9800050491	para pelador 32 mm art.-no. 50481	1		114,72
9800050492	para pelador 40 mm art.-no. 50482	1		117,46
9800050493	para pelador 50 mm art.-no. 50483	1		133,62
9800050494	para pelador 63 mm art.-no. 50484	1		146,35
9800050495	para pelador 75 mm art.-no. 50485	1		165,43
9800050496	para pelador 90 mm art.-no. 50486	1		184,52
9800050497	para pelador 110 mm art.-no. 50487	1		229,06
9800050498	para pelador 125 mm art.-no. 50488	1		235,43



**PLACA DE FIJACIÓN PARA PELADOR UNIVERSAL**

en combinación con, o sin, la extensión para pelador universal. para acoplar en taladro.

Art.-No.	Dimensión	Uds./Paquete	Uds./Caja	Precio € m/pc
9800050499	para pelador universal 50479 – 50484	1	3	190,89
9800050500	para pelador universal 50485 – 50488	1	3	292,69

no se incluye el taladro



**Importante:** No cortar las tuberías aquatherm-pipes con sierras convencionales.

La tubería de aquatherm se puede cortar con sierras tradicionales equipadas con hojas de sierra adecuadas para el plástico.

**Recambios de piezas, como las cuchillas, se pueden solicitar en info@aquatherm.es**

**NUEVO MALETÍN DE PELADORES**

20-63 mm

Art.-No.	Dimensión	Uds./Paquete	Uds./Caja	Precio € m/pc
<b>9800050477</b>	para ø 20-63 mm	1	1	<b>2.376,72</b>

Incluye:

- 1x Maletín
- De cada 1x 50479-50484 pelador universal 20-63 mm
- 1x 50499 placa de fijación para pelador universal 50479-50484
- 1x 50503 kit para pelado manual
- 1x 50504 llave torx T-8
- 1x 50505 llave Allen de 4mm
- 6x 99793 6 tornillos de fijación para Art.-No. 50489-50494 M5x25



**NUEVO MALETÍN DE PELADORES**

75-125 mm

Art.-No.	Dimensión	Uds./Paquete	Uds./Caja	Precio € m/pc
<b>9800050478</b>	para ø 75-125 mm	1	1	<b>2.651,19</b>

Incluye:

- 1 x Maletín
- De cada 1x 50485-50488 pelador universal 75-125 mm
- 1x 50500 placa de fijación para pelador universal 50485-50488
- 1x 50503 1 kit para pelado manual
- 1x 50504 llave torx T-8
- 1x 50505 llave Allen de 4mm
- 6x 99794 6 tornillos de fijación para Art.-No. 50495-50498 M5x35



**PELADOR PARA SOLDADURA POR ELECTROFUSIÓN aquatherm (Art.-No.17208-17238)**

para:

aquatherm green pipe S  
aquatherm green pipe MF RP  
aquatherm green pipe MF TI

aquatherm green pipe MF  
aquatherm blue pipe S  
aquatherm blue pipe MF

aquatherm blue pipe MFTI

Se necesita para eliminar el recubrimiento de óxido (manguitos de electrofusión aquatherm en página 40)



Art.-No.	Dimensión	Uds./Paquete	Uds./Caja	Precio € m/pc
<b>En combinación con la máquina taladro</b>				
<b>9800050558</b>	20 mm	1		<b>179,35</b>
<b>9800050560</b>	25 mm	1		<b>182,59</b>
<b>9800050562</b>	32 mm	1		<b>216,34</b>
<b>9800050564</b>	40 mm	1		<b>209,97</b>
<b>9800050566</b>	50 mm	1		<b>232,18</b>
<b>9800050568</b>	63 mm	1		<b>286,95</b>
<b>9800050570</b>	75 mm	1		<b>375,41</b>
<b>9800050572</b>	90 mm	1		<b>606,78</b>



Art.-No. 50558-50572

En combinación con la máquina taladro (no incluida)

<b>Para pelado manual</b>				
<b>9800050574</b>	110 mm	1		<b>919,75</b>
<b>9800050576</b>	125 mm	1		<b>1.017,43</b>
<b>9800050580</b>	160 mm	1		<b>1.239,20</b>



Art.-No. 50574-50580

Art.-No. 50592

<b>Para pelado manual</b>				
<b>9800050592</b>	200 + 250 mm	1		<b>2.627,86</b>



No adecuado para aquatherm green pipe UV, aquatherm blue pipe UV, aquatherm blue pipe OT y aquatherm green pipe MS

S = individual, MF = multicapa faser, MS = multicapa stabi, OT = Impermeable al oxígeno, UV = protección ultravioleta, TI = aislamiento térmico, RP = resistencia a la presión mejorada

**HERRAMIENTA PARA TOMA EN CARGA**

Para reparar tuberías con presión

La herramienta para toma en carga (Art.-No. 50890) se utiliza para taladrar salidas de 40 y 63 mm en tuberías con fluido en su interior.

Las tuberías green pipe y blue pipe, tanto multicapa con fibra o aluminio como monocapa y capa UV, desde DN75 hasta 630, que transporten agua pueden repararse con una presión interior de hasta **6 bar y temperaturas comprendidas entre 10 y 60 °C.**



Tanto las instrucciones de Hütz + Baumgarten como las de aquatherm deben de ser leídas y entendidas antes de comenzar. Hay que familiarizarse con los controles y procesos de trabajo antes de utilizar la herramienta. Esta herramienta sólo debe manejarla personal preparado, entrenado y capacitado. Estos operarios deben estar familiarizados con las instrucciones y actuar de acuerdo a las mismas.

Encontrará las intrucciones de uso y ejecución en castellano en nuestro manual técnico de green pipe a partir de Mayo 2018.

**HERRAMIENTA PARA TOMA EN CARGA**

para realizar derivaciones en carga

Art.-No.	Dimension	Uds./Paquete	Uds./Caja	Precio € m/pc
<b>9800050890</b>	Para DN40 y DN63mm	1		<b>8.863,47</b>



**ADAPTADOR PARA VÁLVULA DE BOLA**

para realizar derivaciones en carga

para Art.-No. 41494 y 41498

Art.-No.	Dimension	Uds./Paquete	Uds./Caja	Precio € m/pc
<b>9800050891</b>	para válvula de 40 mm	1		<b>2.029,75</b>
<b>9800050892</b>	para válvula de 63 mm	1		<b>2.526,06</b>

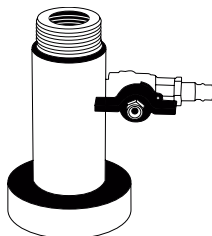

**PP-CORONA DE CORTE**

para realizar derivaciones en carga

para Art.-No. 50891 y 50892

Art.-No.	Dimension	Uds./Paquete	Uds./Caja	Precio € m/pc
<b>9800050893</b>	40 mm	1		<b>3.378,68</b>
<b>9800050894</b>	63 mm	1		<b>4.174,04</b>

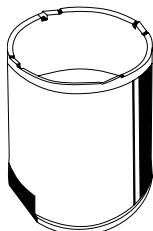

**HERRAMIENTA DE TOMA EN CARGA**

para taladrar tuberías con presión

La herramienta para toma en carga (Art.-No. 50890) se utiliza para taladrar salidas de 40 y 63 mm en tuberías desde DN75 hasta DN630 que tengan presión en su interior.

Se requiere el siguiente material para realizarlo:

- Adaptador válvula de 40 mm Art.-No. 50891
- Adaptador válvula de 63 mm Art.-No. 50892
- Broca para PP de 40 mm Art.-No. 50893
- Broca para PP de 63 mm Art.-No. 50894
- Matriz de derivación en asiento Art.-No. 50760-50773
- Derivación en carga Art.-No. 16175-16300

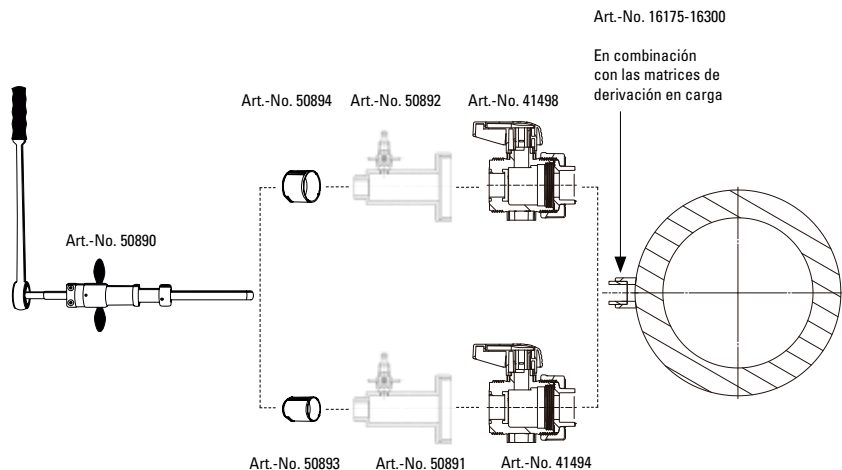



# TABLAS DE PRESIONES DE SERVICIO ADMISIBLES



**PRESIONES DE SERVICIO ADMISIBLES - AGUA POTABLE**

Fluido transportado agua: agua de acuerdo a DIN 2000

Temperatura	Años de servicio	aquatherm green pipe SDR 11 S	aquatherm green pipe SDR 7,4 S	aquatherm green pipe SDR 6 S aquatherm green pipe SDR 7,4 MS	aquatherm green pipe SDR 7,4 MF	aquatherm green pipe SDR 9 MFRP					
		Presión de servicio admisibles en bar y (psi)									
		bar	(psi)	bar	(psi)	bar	(psi)	bar	(psi)	bar	(psi)
20 °C 68 °F	1	15,0	(218)	23,8	(345)	30,0	(435)	28,6	(415)	25,0	(363)
	5	14,1	(205)	22,3	(323)	28,1	(408)	26,8	(389)	24,2	(351)
	10	13,7	(199)	21,7	(315)	27,3	(396)	26,1	(379)	23,9	(347)
	25	13,3	(193)	21,1	(306)	26,5	(384)	25,3	(367)	23,5	(341)
	50	12,9	(187)	20,4	(296)	25,7	(373)	24,5	(355)	23,1	(335)
30 °C 86 °F	1	12,8	(186)	20,2	(293)	25,5	(370)	24,3	(352)	21,7	(315)
	5	12,0	(174)	19,0	(276)	23,9	(347)	22,8	(331)	21,0	(305)
	10	11,6	(168)	18,3	(265)	23,1	(335)	22,0	(319)	20,6	(299)
	25	11,2	(162)	17,7	(257)	22,3	(323)	21,3	(309)	20,2	(293)
	50	10,9	(158)	17,3	(251)	21,8	(316)	20,7	(300)	20,0	(290)
<div style="display: flex; justify-content: space-around;"> <div style="text-align: center;"> <p>Agua potable (Fría)</p> </div> <div style="text-align: center;"> <p>Agua potable (Caliente)</p> </div> </div>	40 °C 104 °F	1	17,1	(248)	21,5	(312)	20,5	(297)	18,7	(271)	
		5	16,0	(232)	20,2	(293)	19,2	(278)	18,0	(261)	
		10	15,6	(226)	19,6	(284)	18,7	(271)	17,7	(257)	
		25	15,0	(218)	18,8	(273)	18,0	(261)	17,4	(252)	
		50	14,5	(210)	18,3	(265)	17,5	(254)	17,0	(247)	
	50 °C 122 °F	1	14,5	(210)	18,3	(265)	17,5	(254)	15,9	(231)	
		5	13,5	(196)	17,0	(247)	16,2	(235)	15,3	(222)	
		10	13,1	(190)	16,5	(239)	15,7	(228)	15,1	(219)	
		25	12,6	(183)	15,9	(231)	15,2	(220)	14,8	(215)	
		50	12,2	(177)	15,4	(223)	14,7	(213)	14,5	(210)	
	60 °C 140 °F	1	12,2	(177)	15,4	(223)	14,7	(213)	13,5	(196)	
		5	11,4	(165)	14,3	(207)	13,7	(199)	13,0	(189)	
		10	11,0	(160)	13,8	(200)	13,2	(191)	12,8	(186)	
		25	10,5	(152)	13,3	(193)	12,6	(183)	12,5	(181)	
		50	10,1	(146)	12,7	(184)	12,1	(175)	12,3	(178)	
	65 °C 149 °F	1	11,6	(168)	14,6	(212)	13,9	(202)	12,4	(180)	
		5	10,8	(157)	13,6	(197)	12,9	(187)	11,9	(173)	
		10	10,4	(151)	13,1	(190)	12,5	(181)	11,7	(170)	
		25	10,0	(145)	12,6	(183)	12,0	(174)	11,4	(165)	
		50	8,8	(128)	11,1	(161)	10,6	(154)	11,2	(162)	
70 °C 158 °F	1	10,3	(149)	13,0	(189)	12,4	(180)	11,4	(165)		
	5	9,5	(138)	11,9	(173)	11,4	(165)	10,9	(158)		
	10	9,3	(135)	11,7	(170)	11,1	(161)	10,7	(155)		
	25	8,0	(116)	10,1	(146)	9,6	(139)	10,5	(152)		
	30	7,0	(102)	8,8	(128)	9,3	(135)	10,3	(149)		
	50	6,7	(97)	8,5	(123)	8,1	(117)	10,2	(148)		

**Tubería compuesta: Elevada presión de servicio con menor espesor de pared y mayor caudal**

- Serie** = (Diámetro - espesor) / 2 x espesor - Serie = (d-e)/2e
- SDR** = Standard Dimension Ratio (diámetro/espesor de pared) - SDR = d/e
- S** = Monocapa (Single layer)
- MS** = Multicapa Stabi - capa integrada de aluminio
- MF** = Multicapa Faser
- MFRP** = Multicapa Faser - Resistencia a la Presión mejorada

Las presiones máximas de servicio admisible, son resultado de las condiciones de trabajo de sistema de tuberías en instalaciones de agua sanitaria. Se han considerado para ello un factor de seguridad adecuado.

Para uniones soldadas a "tope" se recomienda una reducción del factor de seguridad de 0.75 (reducción de los valores de la tabla de un 25%).

**PRESIONES DE SERVICIO ADMISIBLE**

para aplicaciones generales de tubería en régimen permanente y circuito cerrado

Temperatura	Años de servicio	aquatherm blue pipe SDR 17,6 MF		aquatherm blue pipe SDR 11 MF RP & MF RP OT		aquatherm green pipe SDR 7,4 MF		aquatherm green pipe SDR 9 MF RP	
		Presión de servicio admisible en bar y (psi)							
		bar	(psi)	bar	(psi)	bar	(psi)	bar	(psi)
10°C 50 °F	10	13,1	(190,0)	25,3	(366,9)	27,7	(402)	27,5	(399)
	25	12,9	(187,1)	24,7	(358,2)	26,9	(390)	27,1	(393)
	50	12,7	(184,2)	24,1	(349,5)	26,1	(379)	26,7	(387)
	100	12,6	(182,7)	23,5	(340,8)	25,2	(366)	26,3	(381)
15°C 58 °F	10	12,3	(178,4)	23,4	(338,7)	26,9	(390)	25,7	(373)
	25	12,1	(175,5)	22,8	(330,7)	26,1	(379)	25,2	(366)
	50	11,9	(172,6)	22,2	(322,0)	25,3	(367)	24,9	(361)
	100	11,7	(169,7)	21,6	(313,3)	24,5	(355)	24,5	(355)
20°C 68 °F	10	11,4	(165,3)	21,4	(310,4)	26,1	(379)	23,9	(347)
	25	11,2	(162,4)	21,0	(304,6)	25,3	(367)	23,5	(341)
	50	11,0	(159,5)	20,4	(295,9)	24,5	(355)	23,1	(335)
	100	10,9	(158,1)	19,9	(288,6)	23,7	(344)	22,8	(331)
30°C 86 °F	10	9,8	(142,1)	18,3	(265,4)	22,0	(319)	20,6	(299)
	25	9,6	(139,2)	17,8	(258,2)	21,3	(309)	20,2	(293)
	50	9,5	(137,8)	17,3	(250,9)	20,7	(300)	19,9	(289)
	100	9,4	(136,3)	16,8	(243,7)	20,0	(290)	19,7	(286)
40 °C 104 °F	10	8,4	(121,8)	15,5	(224,8)	18,7	(271)	17,7	(257)
	25	8,3	(120,4)	15,0	(217,6)	18,0	(261)	17,3	(251)
	50	8,1	(117,5)	14,6	(211,8)	17,5	(254)	17,1	(248)
	100	8,0	(116,0)	14,1	(204,5)	16,8	(244)	16,8	(244)
50 °C 122 °F	10	7,2	(104,4)	13,0	(188,5)	15,7	(228)	15,1	(219)
	25	7,0	(101,5)	12,6	(182,7)	15,2	(220)	14,7	(213)
	50	6,9	(100,1)	12,2	(176,9)	14,7	(213)	14,5	(210)
	100	6,8	(98,6)	11,9	(172,6)	14,1	(205)	14,3	(207)
60 °C 140 °F	10	6,1	(88,5)	10,9	(158,1)	13,2	(191)	12,7	(184)
	25	5,9	(85,6)	10,6	(153,7)	12,6	(183)	12,4	(180)
	50	5,8	(84,1)	10,3	(149,4)	12,1	(175)	12,2	(177)
70 °C 158 °F	10	5,1	(74,0)	8,5	(123,3)	11,1	(161)	10,7	(155)
	25	5,0	(72,5)	8,3	(120,4)	9,6	(139)	10,4	(151)
	50	4,9	(71,1)	8,1	(117,5)	8,1	(117)	10,2	(148)
75 °C 158 °F	10	4,6	(66,7)	7,7	(111,7)	10,0	(145)	9,7	(141)
	25	4,5	(65,3)	7,6	(110,2)	8,0	(116)	9,5	(138)
	50	4,4	(63,8)	7,3	(105,9)	6,7	(97)	9,3	(135)
80 °C 176 °F	5	4,3	(62,4)	7,2	(104,4)	9,2	(133)	9,0	(131)
	10	4,2	(60,9)	7,0	(101,5)	7,8	(113)	8,9	(129)
	25	4,1	(59,5)	6,8	(98,6)	6,2	(90)	8,6	(125)
90 °C 194 °F	5	3,5	(50,8)	5,9	(85,6)	6,0	(87)	7,4	(107)
	10	3,4	(49,3)	5,8	(84,1)	5,1	(74)	7,3	(106)

**Serie** = (Diámetro - espesor) / 2 x espesor - Serie = (d-e)/2e  
**SDR** = Standard Dimension Ratio (diámetro/espesor de pared) - SDR = d/e  
**S** = Monocapa (Single layer)  
**MS** = Multicapa Stabi - capa integrada de aluminio  
**MF** = Multicapa Faser  
**MF RP** = Multicapa Faser - Resistencia a la Presión mejorada

Para uniones soldadas a inglete, in situ o piezas fabricadas a partir de segmentos de tubería se recomienda una reducción del factor de seguridad de 0.75 (reducción de los valores de la tabla de un 25%) de acuerdo a la DIN 16963-5.

**PRESIONES DE SERVICIO ADMISIBLES**

**Observaciones**

**Tabla de Presiones de Trabajo admisibles para Agua Potable**

La tabla representa los años esperados de servicio de las tuberías bajo las condiciones de servicio expuestas de Presión y Temperatura. Los datos resultantes no tienen, ni pueden tener en cuenta, alteraciones adicionales de las que puedan ser objeto las instalaciones, como por ejemplo elevada concentración de agentes desinfectantes, concentraciones elevadas de materiales metálicos en la red de agua, anomalías en cuanto al funcionamiento de control de presión y temperatura, etc.

La tabla es de uso exclusivo en instalaciones de Agua Sanitaria. Los valores reflejados en la mencionada tabla han sido calculados con un factor de seguridad adecuado. La temperatura de la misma solo se contempla hasta 70°C, teniendo en cuenta esta temperatura no como funcionamiento, si no como choque térmico para desinfección. Cabe resaltar que el choque térmico se efectúa tan solo durante dos horas, una o varias veces al año, lo que resulta un valor no representativo frente a las 8.760 h anuales, por este motivo no supone problema alguno este tipo de desinfección.

Norma EN ISO 9080 - *Sistema de canalización y conducción en materiales plásticos. Determinación de la resistencia hidrostática a largo plazo de materiales termoplásticos en forma de tuberías mediante extrapolación.*

Norma UNE-EN ISO 15874:2003 *Sistemas de canalización en materiales plásticos para instalaciones de agua caliente y fría. Polipropileno (PP). Parte 2: Tuberías.*

**Tabla de Presiones de Trabajo para otras aplicaciones, como circuitos cerrados**

La tabla representa los años esperados de servicio de las tuberías bajo las condiciones de servicio expuestas de Presión y Temperatura. Los datos resultantes no tienen, ni pueden tener en cuenta, alteraciones adicionales de las que puedan ser objeto las instalaciones, como por ejemplo elevada concentración de agentes desinfectantes, concentraciones elevadas de materiales metálicos en la red de agua, anomalías en cuanto a, l funcionamiento de control de presión y temperatura, etc.

La tabla es de uso en otro tipo de instalaciones, diferentes a las sanitarias de agua potable. El factor de seguridad empleado es 1,25.





# CONDICIONES DE VENTA Y SUMINISTRO



### 1.- Identificación

Aquatherm Ibérica S.L. es una empresa de distribución y comercialización en exclusiva para España y Portugal de los productos fabricados por Aquatherm GmbH, con domicilio en Biggen 5, D57439 Attendorn (Alemania) siendo éste el fabricante a los efectos legales correspondientes.

### 2.- Precios

Nuestros precios son sin IVA. Los precios son los vigentes en las fechas de cada suministro. No obstante en el caso de que por razones ajenas a nuestro control, como mayor coste de materias primas, mano de obra, cambio de divisas, etc. se produzcan aumentos de precios en relación con los vigentes en la fecha de formalización de los pedidos, dichos aumentos serán repercutidos, previa comunicación al cliente antes de que le sean entregados los materiales. Mercancía Franco almacén de Madrid o Barcelona. Portes y seguro a cargo del comprador.

### 3.- Pedidos

Los pedidos deberán ser realizados por escrito y se formalizarán después de la conformidad a los mismos de Aquatherm Ibérica, S.L., reservándose esta la facultad de anular o reducir el contenido de los pedidos en cualquier momento.

### 4.- Plazo de entrega

Nuestros plazos de entrega se dan a título informativo, si por causas ajenas a nuestra voluntad no fueran respetados no otorgarían ningún tipo de derecho a indemnización.

### 5.- Riesgos

La mercancía viaja siempre por cuenta del comprador que asume todos los riesgos de robos, daños, pérdidas, etc, pudiendo este asegurar, siempre a su cargo, dicha mercancía si así lo desea.

### 6.- Facturación

Cada entrega constituye objeto de una factura independiente, aunque la entrega conforme sólo una parte del pedido.

### 7.- Condiciones de pago

Serán las especificadas en las condiciones particulares. El domicilio de pago es el de nuestra sede social en Madrid o los domicilios delegados expresamente por Aquatherm Ibérica S.L. en sus libramientos o efectos bancarios. No serán reconocidos como válidos, pagos efectuados a personas no autorizadas. La fecha señalada en los pedidos y consecuentemente para los pagos, son inamovibles. Cualquier demora en la fecha de pago, ocasionará gastos bancarios que se repercutirán en el Cliente, cargando en factura los intereses correspondientes en ese momento. En todo caso serán de aplicación las medidas de lucha contra la morosidad contempladas en la ley 15/2010; así como los requisitos y autorizaciones correspondientes, exigidas por la Ley de Servicios de Pago 16/2009. Todo ello sin perjuicio de que en caso de impago Aquatherm Ibérica S.L. se reserva el derecho de resolver el contrato de compraventa y retirar la mercancía, retener o anular pedidos pendientes de suministro y reclamar todos los gastos que por ello se deriven.

### 8.- Garantía

Las mercancías que Aquatherm Ibérica S.L. comercializa disponen de una garantía de 10 años, que otorga el fabricante Aquatherm GmbH desde la fabricación, siempre que se hayan seguido las recomendaciones de instalación, uso y mantenimiento, así como las de las fichas técnicas y catálogos técnicos de los diferentes productos, y no se haya producido una incorrecta manipulación de las mercancías. Será absolutamente imprescindible consultar las recomendaciones que se pueden encontrar en la web [www.aquatherm.es](http://www.aquatherm.es).

### 9.- Reclamaciones

En caso de discrepancia en pedidos o cantidades, las reclamaciones deberán ser formuladas por el Cliente por escrito, en un plazo máximo de 8 días desde la recepción. Cualquier otra reclamación podrá ser recepcionada por Aquatherm Ibérica S.L. remitiendo en su caso las mismas a Aquatherm GmbH en caso de ser necesario.

### 10.- Anulación y devolución

Con carácter general no se admiten anulaciones ni devoluciones.

### 11.- Otras

Cualquier cláusula de estas condiciones generales, que pudiera ser considerada ilegal o nula por disposiciones del Gobierno o de la Unión Europea, no afectará a la validez del resto de las condiciones generales ni a las demás obligaciones contraídas en las operaciones mercantiles, ni a la misma vigencia de los pedidos registrados en firme, ni a cualquier otro pacto que pudiera establecerse entre las sociedades vendedora y compradora una parte del pedido.

### 12.- Jurisdicción

El Cliente renuncia a su propio fuero, conviniendo ambas partes, que cualquier discrepancia en la interpretación de las presentes condiciones generales o de las específicas pactadas para las propias operaciones mercantiles, serán dirimidas en los Tribunales de Madrid.



**aquatherm ibérica**



Incluye de una amplia gama de accesorios y valvulería, que permite realizar todo tipo de diseños e interconexiones con el resto de sistemas y elementos.

- Completa librería compacta: en tan solo 36 MB.
- Open BIM. Compatible con cualquier software: (*Revit / Archi-cad/...*).
- Completa familia de tuberías y accesorios.
- Sistemas específicos para aplicaciones concretas: Agua Sanitaria, calefacción, climatización, PCI
- En diámetros desde DN 20 hasta DN 630 mm.
- Posibilidad de conexiones a cualquier ángulo necesario.
- Inserción automática de los accesorios durante el dibujo.
- Total conectividad con elementos de otras bibliotecas: (válvulas, bombas, maquinaria, etc..)
- Medición completa y detallada.
- Librería en constante desarrollo y actualización.

PRESENTE EN LOS PROGRAMAS DE CÁLCULO DE CYPE



LIBRERÍA BIM AQUATHERM

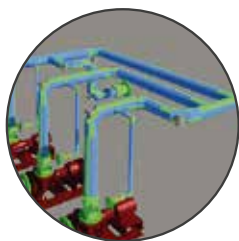
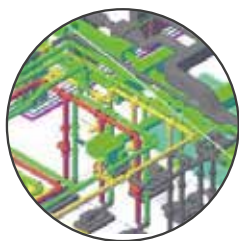

**BIM**  
aquatherm  
green blue red

**AQUATHERM IBERICA S.L.**

MADRID  
C/ Cartpinteros,15  
28320 Pinto  
Tel: 91 380 66 08  
Fax: 91 380 66 09

BARCELONA  
Avenida de la Marina, 12  
08830 Sant Boi de Llobregat  
Tel: 93 630 74 60  
Fax: 93 630 12 18

[www.aquatherm.es](http://www.aquatherm.es)  
[info@aquatherm.es](mailto:info@aquatherm.es)



**aquatherm green pipe**  
**aquatherm blue pipe**  
**aquatherm red pipe**  
**aquatherm orange system**  
**aquatherm grey system**  
**aquatherm black system**

## ESPAÑA

### **aquatherm ibérica SL**

MADRID

C/ Carpinteros, 15 | 28320 Pinto MADRID

Teléfono: +34 91 380 66 08 | Fax: +34 91 380 66 09

info@aquatherm.es | www.aquatherm.es

### **aquatherm ibérica SL**

BARCELONA

Avda de la Marina, 12 | 08830 Sant Boi BARCELONA

Teléfono: +34 93 630 74 60 | Fax: +34 93 630 12 18

info@aquatherm.es | www.aquatherm.es

## PORTUGAL

### **aquatherm ibérica SL**

PORTO (OPORTO)

Rua Professora Angélica Rodrigues, 46, sala 4

4405-269 Vila Nova de Gaia

Teléfono: +351 968906259

geral@aquatherm.pt | www.aquatherm.pt

## ALEMANIA

### **aquatherm GmbH**

(Fabricante)

ATTENDORN

Biggen 5 | D-57439 Attendorf

Phone: +49 (0) 2722 950-0 | Fax: +49 (0) 2722 950-100

info@aquatherm.de | www.aquatherm.de



Management  
System  
ISO 9001:2008  
ISO 14001:2004  
ISO 50001:2011

www.tuv.com  
ID 0091005348