

SISTEMA
NIRON® RED

Sistemas de tuberías y accesorios para instalaciones de protección contra incendios

Tarifa 2019

Ed. Enero 2022



Índice

El sistema y calidad certificada.....	3
Tubería monocapa PP-RCT en barras de 5,8 m y 4 m de largo.....	5
Manguitos electrofusión.....	7
Accesorios termofusión.....	8
Tabla de tiempos de soldadura termofusión	20
Bridas y portabridas.....	21
Válvulas y otros accesorios.....	23
Herramientas.....	24
Máquinas.....	27

* Nota: Esta tarifa mantiene los precios PVP 2019. Actualización de precios PVP Enero 2022 en el artículo bridas, pág.22

[VOLVER AL ÍNDICE](#) 





SISTEMA
NIRON RED

Sistema de tuberías y accesorios de polipropileno homologado para instalaciones de extinción de incendios por bocas de incendios equipadas B.I.E. y rociadores automáticos.

La materia prima empleada en la fabricación del sistema NIRON RED es Polipropileno PP-RCT que dota al sistema de una mejora de la resistencia mecánica, permitiendo mayor presión de servicio a igualdad de espesor de tubería.

La aditivación específica de la materia prima proporciona un comportamiento de reacción al fuego adecuado para las instalaciones de protección contra incendios.

El sistema está formado por tubería monocapa SDR11 Serie 5, accesorios con sistema de fusión térmica o socket y gama específica de componentes con sistema de soldadura por electrofusión.



Calidad certificada Sistema NIRON RED

Acreditación DIT (Documento de Idoneidad Técnico)



Emitido por el Instituto de Ciencias de la Construcción Eduardo Torroja (IETcc).

	
	
DOCUMENTO DE IDONEIDAD TÉCNICA: Nº 643R/21	
Área genérica/Usó previsto: Nombre comercial: Beneficiario: Representante en España: Sede social: Lugar de fabricación: Validez. Desde: Hasta:	Sistema de tubos y accesorios de PP-RCT para instalaciones de extinción de incendios por rociadores NIRON RED ITALSAN, S.L. Pedro Miró Romero Coto de Doñana, 21 28320 Pinto – Madrid NUPI INDUSTRIE ITALIANE S.p.A. Via Stefano Ferrario Z.I Sud Ovest 21052 Bustor Arsizio (Varese, Italia) Via dell'Artigianato, 13 40023 Castelguelfo (Bologna, Italia) 20 de octubre de 2021 1 de julio de 2024 (Condicionada a seguimiento anual)
Este Documento consta de 18 páginas	
	

Instalación de rociadores automáticos.
DIT 643R/21

- Conforme RIPCI aprobado por RD 513/2017.
- Conforme RSCIEI aprobado por RD2267/2004.
- Conforme al ensayo de exposición al fuego realizado en AFITI LICOF.

Clasificación de reacción al fuego Bs1d0 según UNE EN 13501, conforme CTE-DBSI 1 Propagación interior.

	
	
DOCUMENTO DE IDONEIDAD TÉCNICA: Nº 644R/21	
Área genérica/Usó previsto: Nombre comercial: Beneficiario: Representante en España: Sede social: Lugar de fabricación: Validez. Desde: Hasta:	Sistema de tubos y accesorios de PP-RCT para la alimentación de agua (red general de incendios) de sistemas de bocas de incendio equipadas (BIEs) NIRON RED ITALSAN, S.L. Pedro Miró Romero Coto de Doñana, 21 28320 Pinto – Madrid NUPI INDUSTRIE ITALIANE S.p.A. Via Stefano Ferrario Z.I Sud Ovest 21052 Bustor Arsizio (Varese, Italia) Via dell'Artigianato, 13 – 40023 Castelguelfo (Bologna, Italia) 20 de octubre de 2021 1 de julio de 2024 (Condicionada a seguimiento anual)
Este Documento consta de 18 páginas	
	

Instalación de bocas de incendio equipadas (BIEs).
DIT 644R/21



Tubería Monocapa PP-RCT

Tubería monocapa CT SDR11/Serie 5



Descripción

- Tubo monocapa PP-RCT SDR11/Serie 5
- Clase 1/6 bar, clase 2/6 bar
- Clase 4/6 bar, clase 5/4 bar

Suministro

- En barras de 5,8 metros

Referencia	Ø	Espesor (mm)	L (m)	Metros/Bolsa	Palet (m)	Precio (€/m.)
03TNIRRCTRED2011	20 mm	1,8	5,8	145	4350	2,67
03TNIRRCTRED2511	25 mm	2,3	5,8	145	4350	3,90
03TNIRRCTRED3211	32 mm	2,9	5,8	58	1160	5,05
03TNIRRCTRED4011	40 mm	3,7	5,8	58	1160	7,67
03TNIRRCTRED5011	50 mm	4,6	5,8	29	812	11,09
03TNIRRCTRED6311	63 mm	5,8	5,8	23,2	510,4	17,03
03TNIRRCTRED7511	75 mm	6,8	5,8	17,4	348	22,62
03TNIRRCTRED9011	90 mm	8,2	5,8	11,6	232	32,13
03TNIRRCTRED11011	110 mm	10,0	5,8	11,6	162,4	45,14
03TNIRRCTRED12511	125 mm	11,4	5,8	5,8	116	62,22
03TNIRRCTRED16011	160 mm	14,6	5,8	5,8	69,6	89,74
03TNIRRCTRED20011	200 mm	18,2	5,8	5,8	46,4	156,80



Referencia	Ø	Espesor (mm)	L (m)	Metros/Bolsa	Palet (m)	Precio (€/m.)
03TNIRRCTRED2011B4	20 mm	1,8	4	100	3000	2,67
03TNIRRCTRED2511B4	25 mm	2,3	4	100	2000	3,90
03TNIRRCTRED3211B4	32 mm	2,9	4	40	1320	5,05
03TNIRRCTRED4011B4	40 mm	3,7	4	40	800	7,67
03TNIRRCTRED5011B4	50 mm	4,6	4	20	560	11,09
03TNIRRCTRED6311B4	63 mm	5,8	4	16	352	17,03
03TNIRRCTRED7511B4	75 mm	6,8	4	12	240	22,62
03TNIRRCTRED9011B4	90 mm	8,2	4	8	160	32,13
03TNIRRCTRED11011B4	110 mm	10,0	4	8	112	45,14
03TNIRRCTRED12511B4	125 mm	11,4	4	4	80	62,22
03TNIRRCTRED16011B4	160 mm	14,6	4	4	48	89,74
03TNIRRCTRED20011B4	200 mm	18,2	4	4	32	156,80

Quando la tubería se instale por zona sin rociadores y discorra vista en un sector con una resistencia inferior a EI60, se podrá instalar mediante elementos que garanticen una resistencia al fuego EI 60.

Tubería Monocapa PP-RCT NIRON RED

Presiones de servicio tubería monocapa PP-RCT SDR11/Serie 5

NIRON Compuesta PP-RCT SDR11/Serie 5

Clase	1	6	
	2	6	
	4	6	
	5	4	
Tª máxima fluido (oC)	Años en ejercicio continuo	Presión servicio (bar)	Presión servicio (bar)
		Circuito abierto	Circuito cerrado
10	1	19,0	22,8
	5	18,4	22,1
	10	18,2	21,9
	25	17,9	21,5
	50	17,7	21,2
20	1	19,0	19,9
	5	18,4	19,3
	10	18,2	19,0
	25	17,9	18,6
	50	17,7	18,4
30	1	14,3	17,2
	5	13,9	16,6
	10	13,6	16,4
	25	13,4	16,1
	50	13,2	15,8
40	1	12,3	14,8
	5	11,9	14,3
	10	11,7	14,1
	25	11,5	13,8
	50	11,3	13,6
50	1	10,5	12,6
	5	10,1	12,2
	10	10,0	12,0
	25	9,7	11,7
	50	9,6	11,5
60	1	8,9	10,7
	5	8,6	10,3
	10	8,4	10,1
	25	8,2	9,9
	50	8,1	9,7
70	1	7,5	9,0
	5	7,2	8,6
	10	7,0	8,5
	25	6,9	8,3
	50	6,8	8,1
80	1	6,2	7,5
	5	6,0	7,2
	10	5,9	7,0
	25	5,7	6,9
95	1	4,7	5,6
	5	4,4	5,3

Circuito abierto: Coeficiente de seguridad aplicado del 1,5 según norma UNE EN 15874

Circuito cerrado: Coeficiente de seguridad aplicado del 1,25 según norma DIN 8077/78

Accesorio electrofusión PP-RCT

Manguito SDR11 soldadura eléctrica (Clase 1/6, Clase 2/6, Clase 4/6, Clase 5/4)

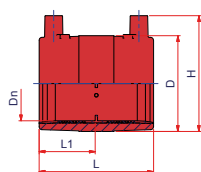

Referencia	Ø	Uds. Caja	Dn (mm)	L1 (mm)	L (mm)	H (mm)	D (mm)	Precio (€/ud.)
03NMERED2011	20 mm	100	20,0	34,0	70,0	52,0	33,0	10,64
03NMERED2511	25 mm	120	25,0	34,0	70,0	58,0	38,5	11,09
03NMERED3211	32 mm	80	32,0	34,0	70,0	65,0	45,5	12,77
03NMERED4011	40 mm	50	40,0	41,0	85,0	75,0	55,0	14,34
03NMERED5011	50 mm	40	50,0	42,5	88,0	87,0	68,0	15,58
03NMERED6311	63 mm	30	63,0	47,5	98,0	100,0	82,0	18,44
03NMERED7511	75 mm	24	75,0	61,0	125,0	114,0	98,0	32,54
03NMERED9011	90 mm	30	90,0	72,0	146,0	130,0	113,0	36,43
03NMERED11011	110 mm	22	110,0	77,0	155,0	144,0	136,0	38,90
03NMERED12511	125 mm	16	125,0	82,0	166,0	167,0	156,5	72,04
03NMERED16011	160 mm	1	160,0	86,5	175,0	201,5	190,0	100,37
03NMERED20011	200 mm	1	200,0	91,5	185,0	243,0	232,0	176,78



Accesorios termofusión

Codo 90° unión socket



Referencia	Tipo	Ø	Uds. Caja	Dn (mm)	D1 (mm)	D (mm)	L1 (mm)	L2 (mm)	L (mm)	H1 (mm)	H (mm)	Precio (€/ud.)
03NGRED20	A	20 mm	200	20,0	16,5	29,0	16,0	27,0	41,5	27,0	41,5	0,59
03NGRED25	A	25 mm	100	25,0	23,5	35,5	16,0	31,0	49,0	31,0	49,0	0,74
03NGRED32	A	32 mm	60	32,0	30,0	46,0	20,0	37,0	60,0	37,0	60,0	1,30
03NGRED40	A	40 mm	40	40,0	36,0	56,0	22,0	43,0	71,0	43,0	71,0	2,35
03NGRED50	A	50 mm	24	50,0	46,0	70,0	25,0	51,0	86,0	51,0	86,0	4,80
03NGRED63	A	63 mm	25	63,0	59,0	88,0	29,0	62,0	106,0	62,0	106,0	7,38
03NGRED75	A	75 mm	15	75,0	70,0	101,0	33,0	73,0	123,5	73,0	123,5	15,30
03NGRED90	A	90 mm	10	90,0	84,0	124,0	37,0	85,0	144,0	85,0	147,0	28,31
03NGRED110	A	110 mm	4	110,0	100,0	146,0	43,0	100,0	173,0	100,0	173,0	39,65
03NGRED125	A	125 mm	4	125,0	113,0	165,0	47,5	125,0	207,5	125,0	207,5	62,12
03NGRED9011160MM *	B	160 mm	1	160,0	-	-	110,0	217,0	-	-	303,0	86,36
03NGRED9011200MM *	B	200 mm	1	200,0	-	-	117,0	250,0	-	-	356,5	Consultar

* Soldar a tope o con accesorio electrosoldable.

Codo 45° unión socket



Referencia	Tipo	Ø	Uds. Caja	Dn (mm)	D1 (mm)	D (mm)	L1 (mm)	L (mm)	H1 (mm)	H (mm)	Precio (€/ud.)
03NC45RED20	A	20 mm	200	20,0	16,5	29,0	16,0	33,0	21,5	46,0	0,75
03NC45RED25	A	25 mm	150	25,0	23,5	34,0	16,0	46,0	24,5	53,5	0,98
03NC45RED32	A	32 mm	40	32,0	30,0	42,0	20,0	56,0	29,0	64,0	1,37
03NC45RED40	A	40 mm	30	40,0	36,0	53,0	22,0	67,0	32,0	72,5	2,85
03NC45RED50	A	50 mm	30	50,0	47,5	66,0	25,0	83,5	39,5	90,0	5,55
03NC45RED63	A	63 mm	35	63,0	60,0	83,0	29,0	102,0	45,0	105,0	7,75
03NC45RED75	A	75 mm	16	75,0	70,0	99,0	33,0	129,5	65,0	145,0	15,30
03NC45RED90	A	90 mm	12	90,0	86,0	123,5	37,0	145,0	57,0	140,0	28,31
03NC45RED110	A	110 mm	6	110,0	100,0	146,0	43,0	172,5	70,0	169,5	39,65
03NC45RED125	A	125 mm	4	125,0	113,0	165,0	47,5	194,0	78,0	189,5	62,12
03NC45RED11160MM *	B	160 mm	1	160,0	-	-	103,0	-	-	311,0	69,00
03NC45RED11200MM *	B	200 mm	1	200,0	-	-	117,0	-	-	402,0	Consultar

* Soldar a tope o con accesorio electrosoldable.



Accesorios termofusión

Manguito unión socket

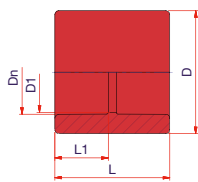

Referencia	Ø	Uds. Caja	Dn (mm)	D1 (mm)	D (mm)	L1 (mm)	L (mm)	Precio (€/ud.)
03NMANRED20	20 mm	200	20,0	18,0	29,0	17,0	35,0	0,54
03NMANRED25	25 mm	150	25,0	20,0	35,0	18,0	39,0	0,59
03NMANRED32	32 mm	40	32,0	30,0	46,0	20,0	43,0	0,99
03NMANRED40	40 mm	50	40,0	37,0	56,0	22,0	48,0	1,60
03NMANRED50	50 mm	20	50,0	47,0	70,0	25,0	54,0	2,98
03NMANRED63	63 mm	15	63,0	60,0	88,0	29,0	62,0	5,10
03NMANRED75	75 mm	35	75,0	70,0	101,0	33,0	71,0	7,18
03NMANRED90	90 mm	24	90,0	87,5	114,5	37,0	77,0	15,89
03NMANRED110	110 mm	12	110,0	106,0	151,0	43,0	92,0	25,59
03NMANRED125	125 mm	4	125,0	117,0	160,0	47,5	102,0	34,55

Te unión socket

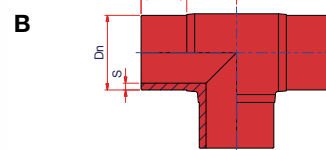
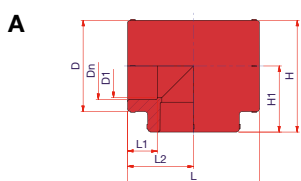

Referencia	Tipo	Ø	Uds. Caja	Dn (mm)	D1 (mm)	D (mm)	L1 (mm)	L2 (mm)	L (mm)	H1 (mm)	H (mm)	Precio (€/ud.)
03NTRED20	A	20 mm	150	20,0	18,0	33,0	16,0	27,0	54,0	27,0	43,5	0,79
03NTRED25	A	25 mm	80	25,0	21,0	35,0	17,0	31,5	63,0	31,5	49,0	0,98
03NTRED32	A	32 mm	40	32,0	30,0	46,0	20,0	37,0	74,0	37,0	60,0	1,61
03NTRED40	A	40 mm	30	40,0	36,0	56,0	22,0	43,0	86,0	43,0	71,0	2,90
03NTRED50	A	50 mm	16	50,0	46,0	70,0	25,0	51,0	102,0	51,0	86,0	7,18
03NTRED63	A	63 mm	24	63,0	59,0	88,0	29,0	62,0	124,0	62,0	106,0	11,09
03NTRED75	A	75 mm	16	75,0	70,0	101,0	33,0	73,0	146,0	73,0	123,5	17,33
03NTRED90	A	90 mm	8	90,0	84,0	124,0	37,0	85,0	170,0	85,0	147,0	32,32
03NTRED110	A	110 mm	4	110,0	100,0	146,0	43,0	100,0	200,0	100,0	173,0	50,99
03NTRED125	A	125 mm	3	125,0	113,0	165,0	47,5	125,0	250,0	125,0	207,5	68,56
03NTRED11160MM *	B	160 mm	1	160,0	-	-	110,0	217,0	-	-	-	96,26
03NTRED11200MM *	B	200 mm	1	200,0	-	-	117,0	250,0	-	-	-	Consultar

* Soldar a tope o con accesorio electrosoldable.



Accesorios termofusión

Te reducida unión socket

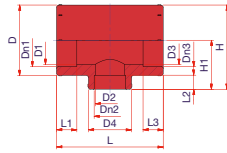

Referencia	Ø	Uds. Caja	Dn1 (mm)	Dn2 (mm)	Dn3 (mm)	D1 (mm)	D2 (mm)	D3 (mm)	D4 (mm)	D (mm)	L1 (mm)	L2 (mm)	L3 (mm)	L (mm)	H1 (mm)	H (mm)	Precio (€/ud.)
03NTRRED252020	25x20x20mm	90	25,0	20,0	20,0	21,0	16,5	16,5	29,0	35,0	17,0	16,0	16,0	62,0	30,0	47,5	1,20
03NTRRED252025	25x20x25mm	80	25,0	20,0	25,0	21,0	16,5	21,0	29,0	35,0	17,0	16,0	17,0	62,0	30,0	47,5	1,20
03NTRRED252520	25x25x20mm	80	25,0	25,0	20,0	21,0	21,0	16,5	35,0	35,0	17,0	17,0	16,0	62,0	30,0	47,5	1,20
03NTRRED322025	32x20x25mm	40	32,0	20,0	25,0	30,0	16,5	21,0	29,0	46,0	20,0	16,0	17,0	75,0	35,0	58,0	1,80
03NTRRED322032	32x20x32mm	40	32,0	20,0	32,0	30,0	16,5	30,0	29,0	46,0	20,0	16,0	20,0	75,0	35,0	58,0	1,80
03NTRRED322532	32x25x32mm	40	32,0	25,0	32,0	30,0	21,0	30,0	35,0	46,0	20,0	17,0	20,0	75,0	35,0	58,0	1,80
03NTRRED323225	32x32x25mm	40	32,0	25,0	25,0	30,0	21,0	21,0	35,0	46,0	20,0	17,0	17,0	75,0	35,0	58,0	1,80
03NTRRED402040	40x20x40mm	20	40,0	20,0	40,0	36,0	16,5	36,0	33,0	53,0	24,0	16,0	24,0	74,0	39,0	66,0	3,39
03NTRRED402540	40x25x40mm	25	40,0	25,0	40,0	36,0	21,0	36,0	33,0	53,0	24,0	20,0	24,0	74,0	39,0	66,0	3,39
03NTRRED403240	40x32x40mm	18	40,0	32,0	40,0	35,0	30,0	35,0	54,0	54,0	22,0	20,0	22,0	87,0	43,0	70,0	3,39
03NTRRED502050	50x20x50mm	12	50,0	20,0	50,0	47,0	16,5	47,0	43,0	66,0	26,0	16,0	26,0	87,0	47,0	80,0	7,35
03NTRRED502550	50x25x50mm	16	50,0	25,0	50,0	47,0	21,0	47,0	43,0	66,0	26,0	20,0	26,0	87,0	47,0	80,0	7,35
03NTRRED503250	50x32x50mm	16	50,0	32,0	50,0	47,0	30,0	47,0	43,0	66,0	26,0	20,0	26,0	87,0	47,0	80,0	7,35
03NTRRED504050	50x40x50mm	10	50,0	40,0	50,0	43,0	36,0	43,0	66,0	66,0	23,0	22,0	23,0	102,0	50,0	83,0	7,35
03NTRRED632563	63x25x63mm	10	63,0	25,0	63,0	60,0	21,0	60,0	53,0	83,0	30,0	21,0	30,0	102,0	54,0	96,0	11,55
03NTRRED633263	63x32x63mm	10	63,0	32,0	63,0	60,0	30,0	60,0	53,0	83,0	30,0	21,0	30,0	102,0	54,0	96,0	11,55
03NTRRED634063	63x40x63mm	6	63,0	40,0	63,0	60,0	36,0	60,0	53,0	83,0	30,0	23,0	30,0	102,0	54,0	96,0	11,55
03NTRRED635063	63x50x63mm	6	63,0	50,0	63,0	50,0	46,0	50,0	80,0	80,0	25,0	26,0	25,0	122,0	64,0	104,0	11,55
03NTRRED753275	75x32x75mm	16	75,0	32,0	75,0	60,0	22,0	60,0	43,0	98,0	30,0	18,0	30,0	139,0	67,0	116,0	18,21
03NTRRED754075	75x40x75mm	14	75,0	40,0	75,0	60,0	36,0	60,0	65,0	98,0	30,0	23,0	30,0	139,0	69,0	118,0	18,21
03NTRRED755075	75x50x75mm	14	75,0	50,0	75,0	70,0	46,0	70,0	70,0	101,0	33,0	25,0	33,0	146,0	73,0	123,5	18,21
03NTRRED756375	75x63x75mm	14	75,0	63,0	75,0	70,0	59,0	70,0	86,0	101,0	33,0	29,0	33,0	146,0	73,0	123,5	18,21
03NTRRED906390	90x63x90mm	8	90,0	63,0	90,0	78,0	50,0	78,0	85,0	120,0	33,0	27,0	33,0	160,0	73,0	133,0	33,20
03NTRRED907590	90x75x90mm	8	90,0	75,0	90,0	87,0	71,0	87,0	114,0	114,0	37,0	33,0	37,0	167,0	83,0	140,0	33,20
03NTRRED11063110	110x63x110mm	5	110,0	63,0	110,0	100,0	59,0	100,0	86,0	146,0	43,0	33,0	43,0	200,0	100,0	173,0	50,99
03NTRRED11075110	110x75x110mm	5	110,0	75,0	110,0	100,0	69,0	100,0	101,0	146,0	43,0	33,0	43,0	200,0	100,0	173,0	50,99
03NTRRED11090110	110x90x110mm	4	110,0	90,0	110,0	100,0	85,0	100,0	119,0	146,0	43,0	37,0	43,0	200,0	100,0	173,0	50,99
03NTRRED12575125	125x75x125mm	20	125,0	75,0	125,0	113,0	69,0	113,0	101,0	165,0	47,5	33,0	47,5	250,0	115,0	197,5	71,92
03NTRRED12590125	125x90x125mm	3	125,0	90,0	125,0	113,0	85,0	113,0	122,0	135,0	47,5	37,0	47,5	250,0	115,0	197,5	71,92
03NTRRED125110125	125x110x125mm	20	125,0	110,0	125,0	113,0	100,0	113,0	146,0	165,0	47,5	250,0	120,0	250,0	120,0	202,5	71,92



Accesorios termofusión

Te reducida - SDR11 macho/macho/macho soldadura a testa o accesorio eléctrico



Inyectado

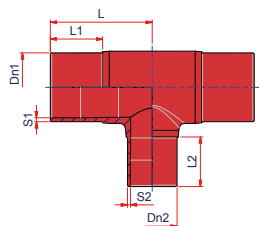

Referencia	Ø	Uds. Caja	Dn1 (mm)	Dn2 (mm)	S1 (mm)	S2 (mm)	L1 (mm)	L2 (mm)	L (mm)	Precio (€/ud.)
03NTRRED1116090M160	160 x 90 x 160 mm	1	160,0	90,0	14,6	8,2	103,0	90,0	190,0	207,38
03NTRRED11160110M160	160 x 110 x 160 mm	1	160,0	110,0	14,6	10,0	103,0	87,0	190,0	208,88
03NTRRED11160125M160	160 x 125 x 160 mm	1	160,0	125,0	14,6	11,4	103,0	95,0	190,0	210,88
03NTRRED11200125M200	200 x 125 x 200 mm	1	200,0	125,0	18,2	11,4	117,0	95,0	230,0	315,00
03NTRRED11200160M200	200 x 160 x 200 mm	1	200,0	160,0	18,2	14,6	117,0	103,0	230,0	382,63

En función del stock disponible, los accesorios pueden ser inyectados o manipulados (Te + Reducción).

La empresa fabricante se reserva el derecho a proveer el accesorio tipo A inyectado o manipulado en función de las necesidades.

Cruz reducida



Referencia	Ø	d1 (mm)	z1 (mm)	D1 (mm)	l1 (mm)	d (mm)	Z (mm)	D (mm)	l (mm)	Precio (€/ud.)
03NCRRED503232	50/32 mm	32,0	26,5	43,0	44,5	50,0	26,0	68,0	45,5	17,90
03NCRRED 633232	63/32 mm	32,0	35,5	52,0	53,5	63,0	32,5	84,0	60,0	19,20
03NCRRED634040	63/40 mm	40,0	33,0	52,0	53,5	63,0	32,5	84,0	60,0	20,15
03NCRRED753232	75/32 mm	32,0	41,0	52,0	59,0	75,0	38,5	100,0	68,5	21,70
03NCRRED754040	75/40 mm	40,0	42,5	68,0	66,0	75,0	38,5	100,0	68,5	24,90
03NCRRED755050	75/50 mm	50,0	51,5	68,0	66,0	75,0	38,5	100,0	68,5	33,16
03NCRRED905050	90/50 mm	50,0	51,5	68,0	75,0	90,0	35,5	120,0	68,5	38,30



Accesorios termofusión

Reducción macho/hembra unión socket

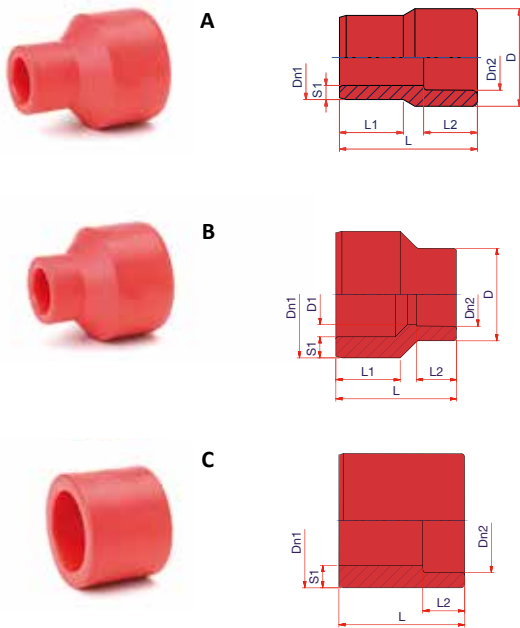

Sugerencia instalación

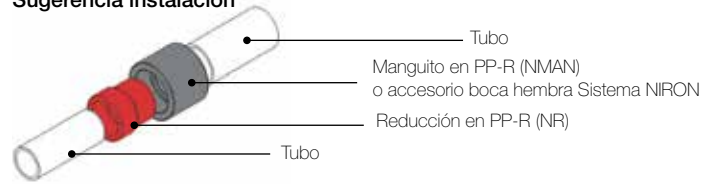

Sugerencia instalación

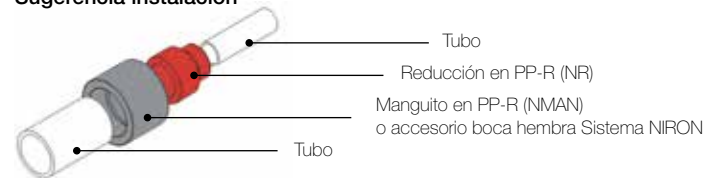

Sugerencia instalación

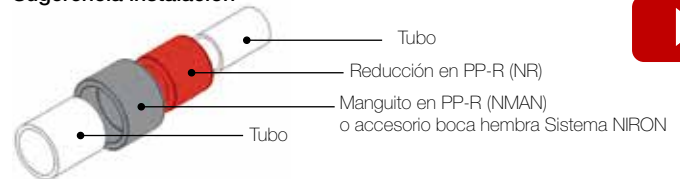

Referencia	Tipo	Ø	Uds. Caja	Dn1 (mm)	S1 (mm)	Dn2 (mm)	D1 (mm)	D (mm)	L1 (mm)	L2 (mm)	L (mm)	Precio (€/ud.)
03NRRED2520	A	25/20 mm	100	25,0	4,2	20,0	-	29,0	19,0	16,0	41,0	0,61
03NRRED3220	B	32/20 mm	80	32,0	5,4	20,0	16,0	29,0	20,0	16,0	45,0	0,84
03NRRED3225	A	32/25 mm	80	32,0	5,4	25,0	-	35,0	22,0	17,0	44,0	0,84
03NRRED4020	B	40/20 mm	60	40,0	6,7	20,0	16,0	29,0	25,0	16,0	45,0	1,58
03NRRED4025	B	40/25 mm	60	40,0	6,7	25,0	21,0	35,0	25,0	17,0	45,0	1,58
03NRRED4032	A	40/32 mm	40	40,0	6,7	32,0	-	46,0	25,0	20,0	50,0	1,58
03NRRED5020	B	50/20 mm	40	50,0	8,3	20,0	16,0	29,0	28,0	16,0	53,0	2,82
03NRRED5025	B	50/25 mm	40	50,0	8,3	25,0	21,0	35,0	28,0	17,0	53,0	2,82
03NRRED5032	B	50/32 mm	30	63,0	8,3	32,0	30,0	46,0	28,0	20,0	53,0	2,82
03NRRED5040	A	50/40 mm	40	50,0	8,3	40,0	-	56,0	28,0	22,0	55,0	2,82
03NRRED6325	B	63/25 mm	30	63,0	10,5	25,0	21,0	35,0	32,0	17,0	60,0	5,10
03NRRED6332	B	63/32 mm	20	63,0	10,5	32,0	30,0	46,0	32,0	20,0	60,0	5,10
03NRRED6340	B	63/40 mm	25	63,0	10,5	40,0	37,0	56,0	32,0	22,0	60,0	5,10
03NRRED6350	A	63/50 mm	20	63,0	10,5	50,0	-	70,0	32,0	25,0	54,0	5,10
03NRRED7520	B	75/20 mm	16	75,0	12,5	20,0	20,0	26,5	35,0	5,0	62,0	8,28
03NRRED7525	B	75/25 mm	20	75,0	12,5	25,0	25,0	33,0	34,0	9,0	62,0	8,28
03NRRED7532	B	75/32 mm	20	75,0	12,5	32,0	32,0	43,0	35,0	12,0	62,0	8,28
03NRRED7540	B	75/40 mm	18	75,0	12,5	40,0	40,0	43,0	35,0	25,0	62,0	8,28
03NRRED7550	B	75/50 mm	20	75,0	12,5	50,0	50,0	66,0	34,0	20,0	59,0	8,28
03NRRED7563	A	75/63 mm	12	75,0	12,5	63,0	-	83,0	36,0	29,0	74,0	8,28
03NRRED9063	C	90/63 mm	10	90,0	15,0	63,0	-	-	-	29,0	81,0	13,45
03NRRED9075	A	90/75 mm	18	90,0	15,0	75,0	-	96,0	37,0	34,0	80,0	14,86
03NRRED11063	B	110/63 mm	25	110,0	18,3	63,0	59,0	88,0	46,0	29,0	80,0	24,95
03NRRED11075	C	110/75 mm	25	110,0	20,8	75,0	-	-	-	32,0	80,0	24,95
03NRRED11090	A	110/90 mm	6	110,0	18,3	90,0	-	130,0	55,0	35,0	110,0	32,62
03NRRED12590	C	125/90 mm	8	125,0	20,8	90,0	-	-	-	37,0	104,0	49,85
03NRRED125110	A	125/110 mm	4	125,0	20,8	110,0	-	139,0	50,0	43,0	114,0	49,85

Accesorios termofusión

Reducción SDR11 macho/macho soldadura a testa o con accesorio eléctrico

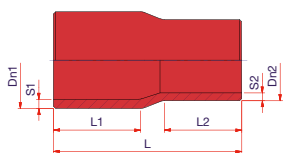

Sugerencia instalación

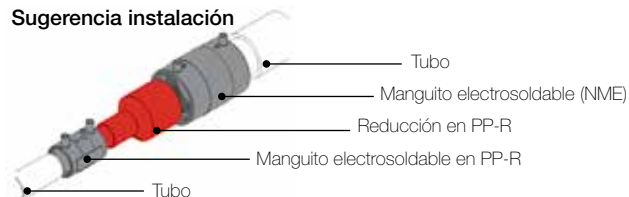

Referencia	Ø	Uds. Caja	Dn1 (mm)	S1 (mm)	Dn2 (mm)	S2 (mm)	L1 (mm)	L2 (mm)	L (mm)	Precio (€/ud.)
03NRRED16011011MM	160/110 mm	1	160,0	14,6	110,0	10,0	103,0	88,0	315,0	64,35
03NRRED16012511MM	160/125 mm	1	160,0	14,6	125,0	11,4	102,0	91,0	214,0	64,35
03NRRED20016011MM	200/160 mm	1	200,0	18,2	160,0	14,5	118,0	101,0	240,0	146,68

Soldar a tope o con accesorio electrosoldable.

Tapón unión socket



A

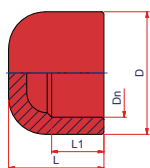

B

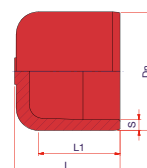

Referencia	Tipo	Ø	Uds. Caja	Dn (mm)	s (mm)	D (mm)	L1 (mm)	L (mm)	Precio (€/ud.)
03NCCRED20	A	20 mm	100	20,0	-	30,0	17,0	29,0	0,94
03NCCRED25	A	25 mm	100	25,0	-	35,5	18,0	34,0	1,34
03NCCRED32	A	32 mm	50	32,0	-	45,0	20,0	40,0	1,63
03NCCRED40	A	40 mm	40	40,0	-	54,0	22,0	42,0	2,33
03NCCRED50	A	50 mm	35	50,0	-	66,0	25,5	48,0	3,91
03NCCRED63	A	63 mm	30	63,0	-	83,0	34,0	56,0	6,63
03NCCRED75	A	75 mm	12	75,0	-	99,0	43,0	61,0	8,86
03NCCRED90	A	90 mm	30	90,0	-	120,0	37,0	62,0	23,02
03NCCRED110	A	110 mm	20	110,0	-	148,0	28,0	68,0	25,39
03NCCRED125	A	125 mm	12	125,0	-	168,0	47,5	80,5	35,79
03NCCRED16011M *	B	160 mm	1	160,0	14,6	-	108,0	142,0	49,96
03NCCRED20011M *	B	200 mm	1	200,0	18,2	-	133,0	172,0	79,02

* Soldar a tope o con accesorio electrosoldable.



Accesorios termofusión

Derivación en asiento / Injertos unión socket

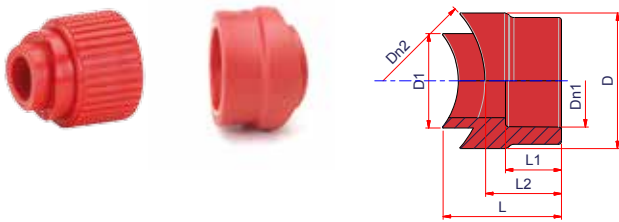

Referencia	Ø tubo	Ø salida	Uds. Caja	Dn1 (mm)	Dn2 (mm)	D1 (mm)	D (mm)	L1 (mm)	L2 (mm)	L (mm)	Precio (€/ud.)
03NGSRED2040	40 mm	20	1	25,0	40	25,0	35,0	15,0	20,0	36,7	2,35
03NGSRED2050	50 mm	20	1	25,0	50	25,0	35,0	15,0	20,0	32,4	2,35
03NGSRED206375	63-75 mm	20	1	25,0	63-75	25,0	35,0	15,0	20,0	30,5	2,35
03NGSRED2090110125	90-110-125 mm	20	1	25,0	90-110-125	25,0	35,0	15,0	20,0	29,5	2,35
03NGSRED20160200	160-200 mm	20	1	25,0	160-200	25,0	35,0	15,0	20,0	28,5	5,73
03NGSRED2540	40 mm	25	1	25,0	40	25,0	35,0	16,5	21,5	38,0	2,35
03NGSRED2550	50 mm	25	1	25,0	50	25,0	35,0	16,5	21,5	33,9	2,35
03NGSRED256375	63-75 mm	25	1	25,0	63-75	25,0	35,0	16,5	21,5	32,0	2,35
03NGSRED2590110125	90-110-125 mm	25	1	25,0	90-110-125	25,0	35,0	16,5	21,5	30,5	2,35
03NGSRED326375	63-75 mm	32	1	32,0	63-75	32,0	46,0	19,0	26,0	40,0	2,35
03NGSRED3290110125	90-110-125 mm	32	1	32,0	90-110-125	32,0	46,0	19,0	26,0	38,0	2,35
03NGSRED32160200	160-200 mm	32	1	32,0	160-200	32,0	46,0	19,0	26,0	36,5	5,57
03NGSRED4090	90 mm	40	1	40,0	90	40,0	58,0	21,0	28,0	42,8	2,57
03NGSRED40110	110 mm	40	1	40,0	110	40,0	58,0	21,0	28,0	41,8	2,50
03NGSRED40125	125 mm	40	1	40,0	125	40,0	58,0	21,0	28,0	40,7	2,50
03NGSRED40160200	160-200 mm	40	1	40,0	160-200	40,0	58,0	21,0	28,0	39,0	6,09
03NGSRED5090	90 mm	50	1	50,0	90	50,0	72,0	25,0	36,0	59,0	3,58
03NGSRED50110	110 mm	50	1	50,0	110	50,0	72,0	25,0	36,0	56,0	3,58
03NGSRED50125	125 mm	50	1	50,0	125	50,0	72,0	25,0	36,0	54,0	3,58
03NGSRED50160	160 mm	50	1	50,0	160	50,0	72,0	25,0	36,0	53,0	8,98
03NGSRED50200	200 mm	50	1	50,0	200	50,0	72,0	25,0	36,0	51,5	9,91
03NGSRED63110	110 mm	63	1	63,0	110	63,0	90,0	29,0	40,0	65,0	5,22
03NGSRED63125	125 mm	63	1	63,0	125	63,0	90,0	29,0	40,0	63,0	5,22
03NGSRED63160	160 mm	63	1	63,0	160	63,0	90,0	29,0	40,0	59,5	6,68
03NGSRED63200	200 mm	63	1	63,0	200	63,0	90,0	29,0	40,0	58,0	10,14



Accesorios roscados termofusión

Enlace rosca hembra unión socket

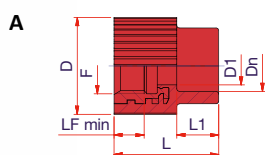

Referencia	Tipo	Ø	Uds. Caja	Dn (mm)	F	LFmin (mm)	D1 (mm)	D (mm)	L1 (mm)	L (mm)	Precio (€/ud.)
03NRFFRED2012L	A	20 mm	70	20,0	1/2"	11,5	14,1	37,0	16,0	40,0	4,64
03NRFFRED2034L	A	20 mm	60	20,0	3/4"	13,2	18,0	43,0	20,5	46,0	5,74
03NRFFRED2512L	A	25 mm	70	25,0	1/2"	11,5	14,1	37,0	17,0	41,0	4,89
03NRFFRED2534L	A	25 mm	60	25,0	3/4"	13,2	18,0	42,0	18,0	46,0	5,40
03NRFFRED3234L	A	32 mm	40	32,0	3/4"	13,2	18,0	45,5	21,5	51,5	9,18
03NRFFRED321L	A	32 mm	40	32,0	1"	18,0	24,0	54,0	20,0	52,0	14,60

Enlace rosca hembra hexagonal unión socket

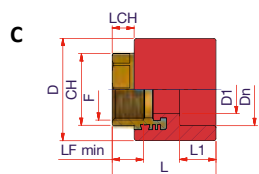
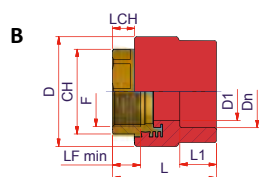

Referencia	Tipo	Ø	Uds. Caja	Dn (mm)	F	LFmin (mm)	D1 (mm)	D (mm)	L1 (mm)	L (mm)	CH (mm)	LCH (mm)	Precio (€/ud.)
03NRFFRED401L	C	40 mm	30	40,0	1"	18,0	24,0	56,0	22,0	67,0	38,0	15,0	16,70
03NRFFRED40114L	B	40 mm	25	40,0	1¼"	21,4	33,0	66,0	22,0	69,0	46,0	15,0	25,90
03NRFFRED50114L	C	50 mm	25	50,0	1¼"	21,4	33,0	70,0	25,0	71,0	46,0	15,0	27,89
03NRFFRED50112L	B	50 mm	14	50,0	1½"	19,0	39,5	75,0	25,0	72,0	55,0	15,0	31,10
03NRFFRED63112L	C	63 mm	15	63,0	1½"	19,0	39,5	88,0	29,0	71,0	55,0	15,0	33,55
03NRFFRED632L	B	63 mm	12	63,0	2"	23,7	50,0	92,0	29,0	80,0	65,0	20,0	48,54
03NRFFRED752L	C	75 mm	8	75,0	2"	23,7	50,0	103,0	33,0	84,0	65,0	20,0	50,25
03NRFFRED75212L	B	75 mm	6	75,0	2½"	30,2	63,5	110,0	33,0	89,0	80,0	20,0	68,97
03NRFFRED903L	B	90 mm	4	90,0	3"	33,3	75,0	129,0	37,0	99,0	95,0	23,0	135,93
03NRFFRED1104L	B	110 mm	2	110,0	4"	39,3	99,5	160,0	43,0	111,0	120,0	30,0	139,94
03NRFFRED1254L	C	125 mm	1	125,0	4"	39,3	99,5	160,0	47,5	115,5	120,0	30,0	161,36



Accesorios roscados termofusión

Enlace rosca macho unión socket

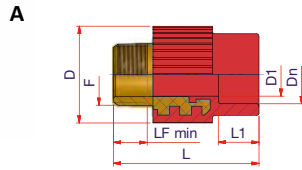

Referencia	Tipo	Ø	Uds. Caja	Dn (mm)	F	LFmin (mm)	D1 (mm)	D (mm)	L1 (mm)	L (mm)	Precio (€/ud.)
03NRFMRED2012L	A	20 mm	70	20,0	1/2"	13,2	14,1	37,0	16,0	55,0	6,63
03NRFMRED2034L	A	20 mm	50	20,0	3/4"	14,5	18,0	43,0	20,5	63,0	6,83
03NRFMRED2512L	A	25 mm	70	25,0	1/2"	13,2	14,1	37,0	17,0	56,0	7,03
03NRFMRED2534L	A	25 mm	50	25,0	3/4"	14,5	18,0	42,0	17,5	62,0	8,86
03NRFMRED3234L	A	32 mm	40	32,0	3/4"	14,5	18,0	45,5	20,0	68,5	10,40
03NRFMRED321L	A	32 mm	30	32,0	1"	16,8	24,0	54,0	20,0	71,0	13,56

Enlace rosca macho hexagonal unión socket

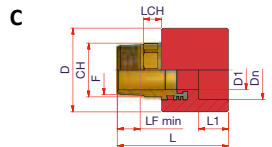
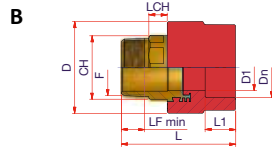

Referencia	Tipo	Ø	Uds. Caja	Dn (mm)	F	LFmin (mm)	D1 (mm)	D (mm)	L1 (mm)	L (mm)	CH (mm)	LCH (mm)	Precio (€/ud.)
03NRFMRED401L	C	40 mm	25	40,0	1"	16,8	24,0	56,0	22,0	86,0	34,0	13,0	18,97
03NRFMRED40114L	B	40 mm	20	40,0	1¼"	19,1	33,0	65,0	22,0	91,0	42,0	15,0	26,25
03NRFMRED50114L	C	50 mm	18	50,0	1¼"	19,1	33,0	70,0	25,0	93,0	42,0	15,0	28,20
03NRFMRED50112L	B	50 mm	15	50,0	1½"	19,1	33,0	70,0	25,0	93,0	42,0	15,0	33,90
03NRFMRED63112L	C	63 mm	10	63,0	1½"	19,1	38,0	88,0	29,0	97,5	50,0	15,0	36,88
03NRFMRED632L	B	63 mm	10	63,0	2"	23,4	49,5	92,0	29,0	105,0	60,0	18,0	46,76
03NRFMRED752L	C	75 mm	6	75,0	2"	23,4	49,5	103,0	33,0	109,0	60,0	18,0	50,82
03NRFMRED75212L	B	75 mm	4	75,0	2½"	26,7	63,5	110,0	33,0	112,0	80,0	20,0	67,86
03NRFMRED903L	B	90 mm	4	90,0	3"	29,8	75,0	129,0	37,0	129,0	90,0	23,0	123,10
03NRFMRED1104L	B	110 mm	1	110,0	4"	35,8	99,5	160,0	43,0	148,0	115,0	30,0	190,94
03NRFMRED1254L	C	125 mm	1	125,0	4"	35,8	99,5	160,0	47,5	152,5	115,0	30,0	221,81



Accesorios roscados termofusión

Codo 90° rosca hembra unión socket

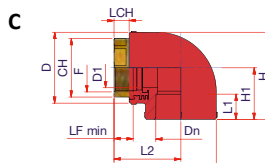
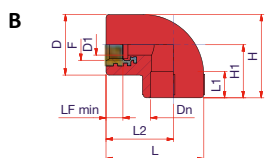
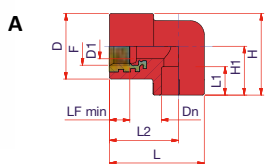

Referencia	Tipo	Ø	Uds. Caja	Dn (mm)	D1 (mm)	D (mm)	F	LF min (mm)	L1 (mm)	L2 (mm)	L (mm)	H1 (mm)	H (mm)	CH (mm)	LCH (mm)	Precio (€/ud.)
03NGFRED2012L	A	20 mm	60	20,0	14,0	37,0	1/2"	11,5	16,0	39,0	53,5	27,5	46,0	-	-	4,01
03NGFRED2512L	A	25 mm	50	25,0	14,0	37,0	1/2"	11,5	17,0	39,0	56,5	30,5	49,0	-	-	6,39
03NGFRED2534L	A	25 mm	40	25,0	18,5	42,0	3/4"	13,2	17,0	39,0	56,5	30,5	51,5	-	-	6,86
03NGFRED3212L	B	32 mm	30	32,0	14,0	42,0	1/2"	11,5	18,0	46,0	67,0	36,0	57,0	-	-	7,93
03NGFRED3234L	B	32 mm	35	32,0	18,5	42,0	3/4"	13,2	18,0	46,0	67,0	36,0	57,0	-	-	8,33
03NGFRED321L	B	32 mm	30	32,0	24,0	54,0	1"	18,0	20,0	46,0	67,0	47,0	74,0	-	-	14,26
03NGFRED401L	B	40 mm	20	40,0	24,0	57,0	1"	18,0	20,0	52,0	79,0	43,0	72,0	46,0	15,0	16,76
03NGFRED50114L	C	50 mm	10	50,0	33,0	70,0	1 1/4"	21,4	25,0	66,0	101,0	51,0	86,0	55,0	15,0	29,36
03NGFRED50112L	C	50 mm	10	50,0	39,5	70,0	1 1/2"	19,0	25,0	66,0	101,0	51,0	86,0	55,0	15,0	42,32
03NGFRED63112L	C	63 mm	4	63,0	39,5	88,0	1 1/2"	19,0	29,0	77,0	121,0	62,0	106,0	65,0	20,0	53,47
03NGFRED632L	C	63 mm	4	63,0	50,0	88,0	2"	23,7	29,0	82,0	126,0	62,0	106,0	65,0	20,0	59,44



Accesorios roscados termofusión

Te rosca hembra unión socket

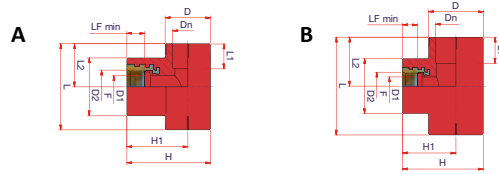

Referencia	Tipo	Ø	Uds. Caja	Dn (mm)	D1 (mm)	D2 (mm)	D (mm)	F	LF min (mm)	L1 (mm)	L2 (mm)	L (mm)	H1 (mm)	H (mm)	Precio (€/ud.)
03NTFRED2012L	A	20 mm	50	20,0	14,1	37,0	29,0	1/2"	11,5	16,0	27,5	55,0	39,0	53,5	5,34
03NTFRED2512L	A	25 mm	40	25,0	14,1	37,0	35,0	1/2"	11,5	17,0	30,5	61,0	39,0	56,5	5,68
03NTFRED2534L	A	25 mm	35	25,0	18,5	42,0	35,0	3/4"	13,2	17,0	30,5	61,0	39,0	56,5	7,24
03NTFRED3212L	B	32 mm	30	32,0	14,1	42,0	42,0	1/2"	11,5	20,0	37,5	75,0	41,0	62,0	7,46
03NTFRED3234L	B	32 mm	35	32,0	18,5	42,0	42,0	3/4"	13,2	20,0	37,5	75,0	41,0	62,0	10,05
03NTFRED321L	B	32 mm	16	32,0	24,0	54,0	42,0	1"	17,8	20,0	47,0	95,0	39,0	66,0	16,09

Rácor loco unión socket

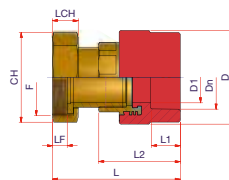

Referencia	Ø	Uds. Caja	Dn (mm)	F	LF (mm)	D1 (mm)	D (mm)	L1 (mm)	L2 (mm)	L (mm)	CH (mm)	LCH (mm)	Precio (€/ud.)
03NBDRED2034	20 mm	10	20,0	3/4"	10,8	14,1	37,0	16,0	40,0	62,0	30,0	14,0	11,11
03NBDRED2534	25 mm	20	25,0	3/4"	10,8	14,1	37,0	17,0	41,0	62,0	30,0	14,0	12,45
03NBDRED251	25 mm	10	25,0	1"	11,5	18,0	42,0	18,0	46,0	70,5	37,0	15,0	13,91
03NBDRED321	32 mm	15	32,0	1"	11,5	18,0	45,5	21,5	51,0	76,0	37,0	15,0	24,04
03NBDRED32114	32 mm	30	32,0	1 1/4"	14,0	24,0	54,5	20,0	53,0	81,0	46,0	18,0	29,32
03NBDRED40114	40 mm	20	40,0	1 1/4"	14,0	24,0	56,0	22,0	67,0	93,0	46,0	18,0	36,54
03NBDRED40112	40 mm	20	40,0	1 1/2"	14,0	33,0	66,0	22,0	69,0	98,0	52,0	18,0	42,84
03NBDRED50112	50 mm	16	50,0	1 1/2"	14,0	33,0	70,0	25,0	56,0	101,0	52,0	18,0	81,96
03NBDRED502	50 mm	10	50,0	2"	17,5	39,5	76,5	25,0	72,0	107,0	64,5	24,0	95,14
03NBDRED632	63 mm	10	63,0	2"	17,5	39,5	88,0	29,0	75,0	110,0	64,5	24,0	105,86
03NBDRED63212	63 mm	8	63,0	2 1/2"	21,0	50,0	93,0	29,0	81,0	135,5	81,5	25,5	134,65



Accesorios roscados termofusión

Injerto rosca hembra unión socket

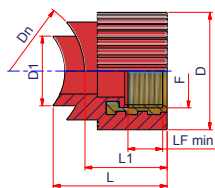

Referencia	Dn tubo (mm)	Dn agujero (mm)	Uds. Caja	F	LF min (mm)	D1 (mm)	D (mm)	L1 (mm)	L (mm)	Precio (€/ud.)
03NGSFRED124050L	40-50	25,0	70	1/2"	11,5	25,0	37,0	31,5	45,0	7,98
03NGSFRED126375L	63-75	25,0	70	1/2"	11,5	25,0	37,0	31,5	42,0	7,98
03NGSFRED1290110125L	90-110-125	25,0	70	1/2"	11,5	25,0	37,0	31,5	41,0	8,27
03NGSFRED12160200L	160-200	25,0	70	1/2"	11,5	25,0	37,0	31,5	40,0	9,46
03NGSFRED344050L	40-50	25,0	70	3/4"	13,2	25,0	42,0	33,5	47,0	10,43
03NGSFRED346375L	63-75	25,0	70	3/4"	13,2	25,0	42,0	33,5	44,0	9,75
03NGSFRED3490110125L	90-110-125	25,0	70	3/4"	13,2	25,0	42,0	33,5	43,0	9,75
03NGSFRED16375L	63-75	32,0	40	1"	18,0	32,0	54,0	38,0	52,0	15,50
03NGSFRED190110125L	90-110-125	32,0	40	1"	18,0	32,0	54,0	38,0	50,0	15,50
03NGSFRED1160200L	160-200	32,0	1	1"	18,0	32,0	54,0	38,0	48,5	16,34

Accesorios ranurados

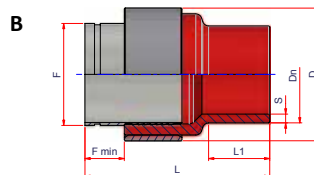
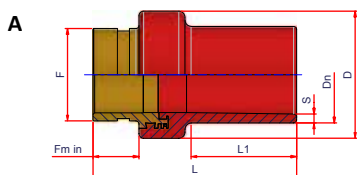

Referencia	Tipo	Dn (mm)	Uds. Caja	S	F	F min (mm)	L1 (mm)	L (mm)	D (mm)	Precio (€/ud.)
03NRVRED5011	A	50	1	4,6	1 1/2"	30	61	125	70	33,27
03NRVRED6311	A	63	1	5,8	2"	30	69	133	83	44,05
03NRVRED7511	A	75	1	6,8	2 1/2"	30	80	145	107	65,76
03NRVRED9011	A	90	1	8,2	3"	30	87	159	118	205,02
03NRVRED11011	A	110	1	10	4"	40	85,5	175	153	280,82
03NRVRED12511	A	125	1	11,4	4"	40	95	187	153	356,57
03NRVRED16011	B	160	1	14,6	6"	65	101	305	219	683,33
03NRVRED20011	B	200	1	18,2	8"	74	170	365	273	1.105,56



Accesorios de termofusión - Unión socket

Procedimiento de soldadura Unión socket hasta diámetro 125mm.
Según norma DVS 2207

Ø Tubería	Calentamiento (segundos)	Ensamblaje (segundos)	Prueba a los minutos	Inserción tubo (mm)
16 mm	5	4	2	13
20 mm	5	4	2	14
25 mm	7	4	3	15
32 mm	8	6	4	17
40 mm	12	6	4	18
50 mm	18	6	4	20
63 mm	24	8	6	26
75 mm	30	8	6	29
90 mm	40	8	6	32
110 mm	50	10	8	35
125 mm	60	10	8	40

Injerto	Calentamiento (segundos)	Ensamblaje (segundos)	Prueba a los minutos
25 mm	7	4	10
32 mm	8	6	10

El tiempo de calentamiento se inicia cuando la tubería y el accesorio alcanzan la profundidad de inserción de la tabla adjunta. No se deben superar las profundidades de inserción debido que puede derivar en un problema de obturación de la tubería en diámetros pequeños.



Bridas y portabridas

Portabridas

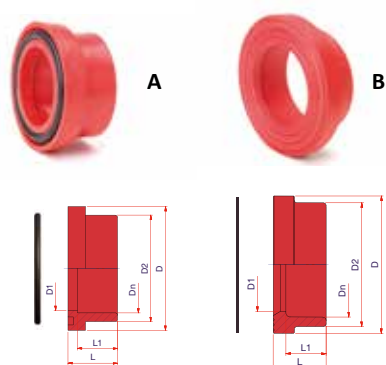

Referencia	Tipo	Ø	Uds. Caja	Dn (mm)	D (mm)	D1 (mm)	D2 (mm)	L1 (mm)	L (mm)	Precio (€/ud.)
PORTABRIDAS CON JUNTA TÓRICA UNIÓN SOCKET: SE SUMINISTRA CON JUNTA TÓRICA										
03NCOSARED32	A	32 mm	100	32,0	51,0	28,0	40,6	18,0	26,0	4,46
03NCOSARED40	A	40 mm	50	40,0	64,0	36,0	49,4	20,5	30,0	6,14
03NCOSARED50	A	50 mm	36	50,0	73,2	45,5	61,0	23,5	34,0	9,31
03NCOSARED63	A	63 mm	20	63,0	90,5	56,5	76,0	27,5	38,0	11,29
03NCOSARED75	A	75 mm	12	75,0	104,5	71,0	90,0	30,0	42,0	13,02
PORTABRIDAS CON JUNTA PLANA UNIÓN SOCKET: NO SE SUMINISTRA CON JUNTA PLANA (AÑADIR EN EL PEDIDO JUNTA EGR)										
03NCOSARED90	B	90 mm	8	90,0	138,0	84,0	107,0	37,0	46,0	18,51
03NCOSARED110	B	110 mm	10	110,0	158,0	102,0	131,0	43,0	57,0	26,68
03NCOSARED125	B	125 mm	8	125,0	160,0	120,0	146,0	47,5	62,5	51,63

Portabridas largo SDR11 soldadura a testa o accesorio eléctrico

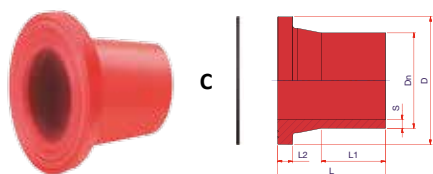

Referencia	Tipo	Ø	Uds. Caja	Dn (mm)	S (mm)	D (mm)	L1 (mm)	L2 (mm)	L (mm)	Precio (€/ud.)
03NCRTRED16011	C	160 mm	1	160,0	14,6	212,0	105,0	25,0	180,0	88,15
03NCRTRED20011	C	200 mm	1	200,0	18,2	268,0	125,0	32,0	200,0	228,18

NO SE SUMINISTRA CON JUNTA PLANA (AÑADIR EN EL PEDIDO JUNTA EGR)



Bridas y portabridas

Brida de aluminio PN16 para accesorio socket o con accesorio eléctrico. Sistema métrico EN 1092



Referencia	Ø Tubería NIRON	Ø Interior brida (mm)	Ø Exterior brida (mm)	Uds. Caja	Nº agujeros	Distancia agujeros (mm)	Ø agujeros (mm)	Para conexión con válvula	PN	Precio (€/ud.)
SOCKET										
NFLA32	32 mm	45,0	115,0	1	4	85,0	14,0	DN25 1"	10/16	17,89
NFLA40	40 mm	51,0	140,0	1	4	100,0	18,0	DN32 1 1/4"	10/16	31,23
NFLA50	50 mm	62,0	150,0	1	4	110,0	18,0	DN40 1 1/2"	10/16	33,75
NFLA63	63 mm	78,0	165,0	1	4	125,0	18,0	DN50 2"	10/16	38,03
NFLA75	75 mm	92,0	185,0	1	4	145,0	18,0	DN65 2 1/2"	10/16	51,27
NFLA90	90 mm	110,0	200,0	1	8	160,0	18,0	DN80 3"	10/16	58,20
NFLA110	110 mm	133,0	220,0	1	8	180,0	18,0	DN100 4"	10/16	65,31
NFLA125B	125 mm	149,0	250,0	1	8	210,0	18,0	DN125 5"	10/16	79,84
SOLDADURA A TESTA										
NFLA160	160 mm	178,0	285,0	1	8	240,0	22,0	DN150 6"	10/16	101,19
NFLA20016	200 mm	238,0	340,0	1	12	295,0	22,0	DN200 8"	16	160,44



Otros accesorios

Válvula de paso de esfera. Cuerpo en PP-R y esfera latón níquel OT unión socket



Referencia	Ø	Uds. Caja	Dn (mm)	Precio (€/ud.)
03NRSPP20	20 mm	50	20,0	40,84
03NRSPP25	25 mm	25	25,0	42,52
03NRSPP32	32 mm	15	32,0	61,18
03NRSPP40	40 mm	10	40,0	84,99
03NRSPP50	50 mm	6	50,0	145,04

Flexo



Referencia	Descripción	Longitud	Uds. Caja	Precio (€/ud.)
FINRED70M1H12	Conector flexible a rociador M 1"-H 1/2" sin refuerzo	70 cm	1	30,72
FINRED100M1H12	Conector flexible a rociador M 1"-H 1/2" sin refuerzo	100 cm	1	32,40
FINRED150M1H12	Conector flexible a rociador M 1"-H 1/2" sin refuerzo	150 cm	1	39,59



Herramientas

Matrices para accesorios unión socket



Referencia	Ø	Uds. Caja	Precio (€/ud.)
NMATRICE20A	20 mm	1	56,44
NMATRICE25A	25 mm	1	59,18
NMATRICE32A	32 mm	1	67,11
NMATRICE40A	40 mm	1	86,02
NMATRICE50A	50 mm	1	102,80
NMATRICE63A	63 mm	1	118,35
NMATRICE75A	75 mm	1	155,58
NMATRICE90A	90 mm	1	210,48
NMATRICE110A	110 mm	1	278,65
NMATRICE125A	125 mm	1	344,70

Matrices para injertos NGS y NGSF



Referencia	Para el injerto	Ø	Uds. Caja	Precio (€/ud.)
NMATGS4025	NGS2040 - NGS2540	40/25 mm	1	159,34
NMATGS5025	NGS2050 - NGS2550 - NGSF124050 - NGSF344050	50/25 mm	1	159,34
NMATGS637525	NGS206375 - NGS256375 - NGSF126375 - NGSF346375	63-75/25 mm	1	159,34
NMATGS9011012525	NGS2090110125 - NGS2590110125 - NGSF1290110125 - NGSF3490110125	90-110-125/25 mm	1	159,34
NMATGS16020025	NGS20160200 - NGS25160200 - NGSF12160200 - NGSF34160200	160-200/25 mm	1	159,34
NMATGS637532	NGS326375 - NGSF16375	63-75/32 mm	1	176,14
NMATGS9011012532	NGS3290110125 - NGSF190110125	90-110-125/32 mm	1	176,14
NMATGS16020032	NGS32160200	160-200/32 mm	1	176,14
NMATGS9040	NGS4090	90/40 mm	1	183,60
NMATGS11040	NGS40110	110/40 mm	1	183,60
NMATGS12540	NGS40125	125/40 mm	1	183,60
NMATGS16020040	NGS40160200	160-200/40 mm	1	252,96
NMATGS9050	NGS5090	90/50 mm	1	286,62
NMATGS11050	NGS50110	110/50 mm	1	286,62
NMATGS12550	NGS50125	125/50 mm	1	286,62
NMATGS16050	NGS50160	160/50 mm	1	286,62
NMATGS20050	NGS50200	200/50 mm	1	286,62
NMATGS25050	NGS50250	250/50 mm	1	286,62
NMATGS11063	NGS63110	110/63 mm	1	304,98
NMATGS12563	NGS63125	125/63 mm	1	304,98
NMATGS16063	NGS63160	160/63 mm	1	304,98
NMATGS20063	NGS63200	200/63 mm	1	304,98

Herramientas

Fresa para injerto NGS y NGSF



Referencia	Tipo	Ø	Uds. Caja	Precio (€/ud.)
NFGS25	A	25 (agujero Ø 23 mm)	1	117,30
NFGS32	A	32 (agujero Ø 30 mm)	1	132,60
NFGS40	B	40 (agujero Ø 38,5 mm)	1	205,02
NFGS50	B	50 (agujero Ø 48,5 mm)	1	228,48
NFGS63	B	63 (agujero Ø 61,5 mm)	1	253,98

Tapón de prueba



Referencia	Ø	Uds. Caja	F (mm)	LF (mm)	L (mm)	D (mm)	Precio (€/ud.)
NTC12	1/2" gas	100	1/2"	18,70	48,0	29,0	1,31
NTC34	3/4" gas	100	3/4"	18,87	48,0	29,0	1,60

Rascador



Referencia	Uds. Caja	Precio (€/ud.)
NRAM1	1	24,13

Rascador giratorio



Referencia	Ø SDR11	Peso (kg)	Uds. Caja	Precio (€/ud.)
RAT1A *	75-200 mm	2,8	1	A consultar

* Rascador con bolsa para transporte.

Herramientas

Alineador para accesorios electrosoldables



A



B



C

Referencia	Tipo	Ø	Peso (kg)	Uds. Caja	Precio (€/ud.)
99500010	A	20/63 mm	3,0	1	A consultar
99220003	B	63/180 mm	7,5	1	A consultar
99220001	C	125/500 mm	7,5	1	A consultar

Tijeras para tubos



A



B



C

Referencia	Tipo	Ø	Uds. Caja	Precio (€/ud.)
NTTTP	A	16/32 mm	1	68,14
NTTT1	B	16/40 mm	1	52,07
NTTT2	C	16/75 mm	1	260,86
NRLP (Hoja para NTTTP)			1	38,72

Cortatubos telescópico



Referencia	Ø	Uds. Caja	Precio (€/ud.)
70031	6/63 mm	1	A consultar
70032	50/125 mm	1	A consultar
70033	110/160 mm	1	A consultar



Máquinas de soldadura por termofusión

Polifusor con maletín y con matrices



Referencia	Voltaje	Ø	Matrices (mm)	Uds. Caja	Precio (€/ud.)
NSBEP	220V	Hasta 63mm	20/25/32	1	564,08
NSBEP63	220V	Hasta 63mm	20/25/32/40/50/63	1	708,90
NSBEP125	220V	Hasta 125mm	75/90/110/125	1	1.414,74

Polifusor con caballete diámetro máximo 63 mm (sin matrices)



Referencia	Voltaje	Ø	Uds. Caja	Precio (€/ud.)
NPCCE	220V	Hasta 63mm	1	376,27

Polifusor con caballete diámetro máximo 125 mm (sin matrices)



Referencia	Voltaje	Ø	Uds. Caja	Precio (€/ud.)
NPCCE125	220V	Hasta 125mm	1	764,99



Máquinas de soldadura por termofusión

Aproximador



Precio especial Polifusor Ø 125 mm más matrices de 75, 90 y 110 mm con su bolsa de transporte. Solicite precio para el KITNIRON APROXIMADOR.

Referencia	Ø	Uds. Caja	Precio (€/ud.)
94650001	63-125 mm	1	A consultar

Aproximador universal "SPIDER"

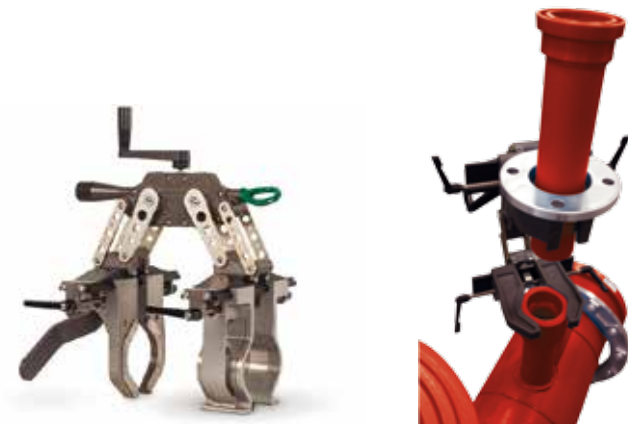

Características

- Accionado a mano
- Mecanismo de engranajes no reversibles con auto bloqueo
- Palanca de soporte de dos posiciones
- Liviana y compacta
- Autocentrabre

Referencia	Ø	Recorrido máximo (mm)	Peso máquina completa (kg)	Uds. Caja	Precio (€/ud.)
A467601	63-125 mm	193,0	6,8	1	A consultar



Máquinas de soldadura por electrofusión

Máquina de soldar automática polivalente con escáner óptico y sistema Bluetooth integrado



Peso	25,2 kg
Dimensiones	340 x 450 x 220 mm
Potencia máxima absorbida	4.000 VA
Alimentación	230V
Corriente pico	100 A
Corriente soldadura 60% Duty Cycle	73 A
Frecuencia	50 - 60Hz
Temperatura de uso	De -18°C a +55°C
Pantalla	Visor retroiluminado dispuesto en 4 líneas de 20 dígitos
Protección IP	54
Tensión de soldadura	5-42V
Memoria	10.000 ciclos
Diámetros con los que puede trabajar	20 ÷ 630 mm

Referencia	Ø	Uds. Caja	Precio (€/ud.)
E9001E	20-630 mm	1	A consultar

Máquina de soldar automática "ELEKTRA LIGHT"



Peso	7 kg
Dimensiones	200 x 250 x 210 mm
Potencia máxima absorbida	1.300 W
Alimentación	110V o 230V
Corriente pico	60 A
Corriente soldadura 60% Duty Cycle	23 A
Frecuencia	50 - 60Hz
Temperatura de uso	De -10°C a +50°C
Precisión del termómetro	1°C
Protección IP	54
Tensión de soldadura	8-48V
Memoria	325 ciclos
Diámetros con los que puede trabajar	20 ÷ 125/160 * mm

Referencia	Ø	Uds. Caja	Precio (€/ud.)
96906063	20-125/160* mm	1	A consultar

* Es posible soldar el diámetro 160 mm tomando la precaución de esperar el enfriamiento de la máquina, después de cada soldadura.



Máquinas de soldadura por electrofusión

Máquina de soldar con scanner "ELEKTRA 315"



Peso	16 kg
Dimensiones	263 x 240 x 300 mm
Potencia máxima absorbida	2.600 W
Alimentación	110V o 230V
Corriente pico	100 A
Corriente soldadura 60% Duty Cycle	60 A
Frecuencia	50 - 60Hz
Temperatura de uso	De -10°C a +50°C
Protección IP	54
Tensión de soldadura	8-48V
Memoria	500 ciclos
Diámetros con los que puede trabajar	20 ÷ 315 mm

Referencia	Ø	Uds. Caja	Precio (€/ud.)
96906126	20-315 mm	1	A consultar





Sede Madrid

Coto de Doñana, 21
28320 Pinto - Madrid
Tel: 91 806 07 23
Fax: 91 803 30 49

Sede Barcelona

C/ Progrés, 29
Pl. Les Massotes
08850 Gavá - Barcelona
Tel: 93 630 30 40
Fax: 93 633 60 42

Atención al cliente:

900 921 957

www.italsan.com
atencionalcliente@italsan.com

ITALSAN no se responsabiliza de posibles errores que aparezcan en la presente tarifa, y se reserva el derecho de modificar sin previo aviso las características y precios* de los productos.

Para cualquier consulta dirigirse a atencionalcliente@italsan.com

*Precios sin IVA.

Distribuido por:



TAR/RED/2019/042020